

3D Assembly Processes a Look at Today and Tomorrow

David Geiger, Georgie Thein
AEG, FLEXTRONICS International Inc.
847 Gibraltar Drive, Milpitas, CA 95035, USA

ABSTRACT

The world of electronics continues to increase functional densities on products. One of the ways to increase density of a product is to utilize more of the 3 dimensional spaces available. Traditional printed circuit boards utilize the x/y plane and many miniaturization techniques apply to the x/y space savings, such as smaller components, finer pitches, and closer component to component distances.

This paper will explore the evolution of 3D assembly techniques, starting from flexible circuit technology, cavity assembly, embedded technology, 3 dimensional surface mount assembly, etc.

We will explore various technologies available today and some that are starting to appear. This paper will illustrate some of the key items for each technology and what some of the key challenges would apply. The assembly processes needed for each of these areas will be touched upon and what items will be needed to be enhanced for continuing the drive to better utilization of the z axis area available on pcba processing.

Key words: 3D, miniaturization, 0201, component spacing

Introduction

Printed circuit board assembly (PCBA), starting with plated through hole, later evolve to surface mount assembly, have been planar in 2 dimension. Components are mounted onto PCBA in the x and y direction, where the height, z direction, is controlled by the component height.

On the assembly level, board to board and board to flexible printed circuit (FPC) are commonly used to interconnect two or more PCBAs together to create a three dimensional structure. On the PCB level, we will look at several techniques aimed at reducing the number of components mounted on the surface. On the PCBA level, certain 3D assembly techniques have been developed to address reduction in board available space or reduction in overall assembly thickness. These techniques include Package-on-Package (PoP) and Cavity assembly.

We will also take a glimpse into the future, based on technologies available now, to examine potential assembly methods on the horizon for 3D assemblies.

Discussion

Assembly Level

As the PCBA started with a two dimension assembly using one single FR4 rigid PCB, where plated thru hole and surface mount components are placed in the x and y direction, various methods are in use to interconnect multiple PCBAs together to create a three dimension assembly.

Board to Board (B2B) level connectors are the most common. These include connectors using PTH or SMT. Some examples are daughter board mounted onto a motherboard, high speed/high density connection between backplane and functional cards, etc. B2B connections create a rigid three dimensional assembly structure where PCBA orientation has to follow the x, y, and z axis. It was difficult to interconnect PCBAs at various angles at will. PCBAs can either

stack on top of each other, or be connected at 90 degrees to each other. The connector, whether PTH or SMT, also takes up valuable board surface area in today's high density application.



Figure 1 – 3D Assembly using Board to Board Connectors¹

Using flexible printed circuit (FPC) as the interconnect, we can orient the PCBAs in various angles as required by the application. To connect the FPC to the rigid board, various methods have been developed. With board to FPC (B2F) connectors, the FPC can be easily inserted and removed as needed. This is most commonly used to connect the FPC from the display panel to the PCBA. To reduce the cost of the assembly by removing the connector, direct attachment method is used.

Direct attachment includes soldering, or the use of anisotropic conductive film (ACF) or paste (ACP). With soldering, it can be performed with a soldering iron, but for reliability and repeatability, typically a hot bar soldering process is used. The pads on the PCBA and FPC are pre-tinned with solder. A thermode head is designed to fit the pad areas of the FPC, and provide consistent heat to solder the FPC to the PCBA. Usually a pad to pad pitch of around 1.0mm is required to avoid solder bridging between pads during the hot bar soldering process. The hot bar solder joint is reworkable, but usually the FPC is damaged during removal and must be discarded, along with the display if it is attached to one. The pads on the PCBA can be cleaned up and be ready for soldering again.

To connect the FPC to the PCBA with finer pad to pad pitch (down to 0.2mm), ACF or ACP can be used. The ACF or ACP replaces the pre-tinned solder on the pads. Conductive particles inside the ACF or ACP are compressed to allow an electrical connection in the z axis between the pad on the FPC to the pad on the PCBA. Due to the pads on the FPC and PCBA which are non-solder mask defined, this creates a hill and valley profile for the ACF material. The hill (where the pads align) compresses the conductive particles. The valley (empty area) allows the conductive particles to remain in suspension in the ACF or ACP. This attachment method is reworkable, and the FPC is usually not damaged during the rework.

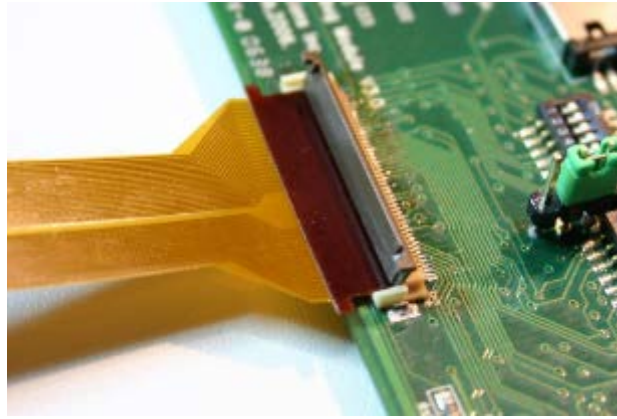

Figure 2 – Board to FPC using connector

To further reduce the attachment of the FPC to the PCBA, the PCB manufacturer can now integrate the FPC as part of the rigid PCBA layer. This creates a Rigid-Flex PCB. This provides further flexibility on how the PCBAs on a rigid-flex can be oriented and positioned.

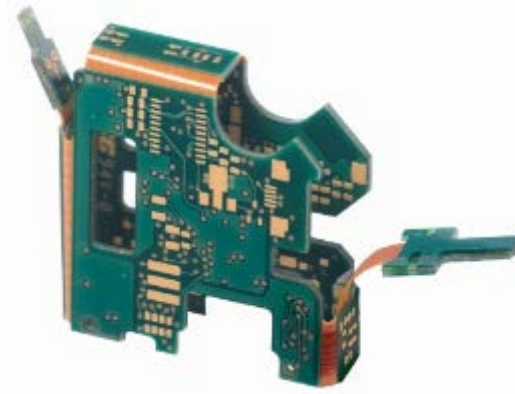

Figure 3 – Example of a Rigid-Flex PCB²

PCB Level

The top and bottom layer of a printed circuit board (PCB) are where the components are installed to form the circuitry. Physical pads and traces are needed to provide the footprint and signal path to connect the circuitry. To reduce the number of components on the top and bottom layer, while maintaining the same functionality of circuitry, buried capacitance can be used. This creates a single value of capacitance across the layers inside the PCB, usually used to replace bypass capacitors on the surface.

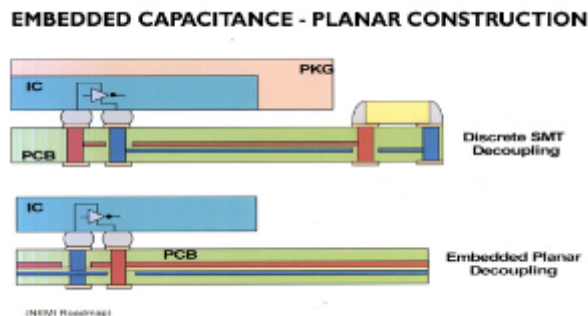

Figure 4 – Buried Capacitance Inside PCB³

Due to miniaturization of the assembly, and the need to add more circuitry function while maintaining or reducing overall PCBA dimension, we will look at several techniques aimed at reducing the components mounted on the surface. Embedded passives place different values of resistors and capacitors inside the inner layer of PCB. Compared to buried capacitance, this allows for further reduction in components required on the top and bottom surface. Embedded actives place an integrated circuit chip into the inner layer of PCB. Both of these techniques involve assembling the components onto a single layer of PCB first, then build up multiple layers of PCB around it. Or the remaining layers are made separately and cavity is cutout to provide relief space for the embedded components.

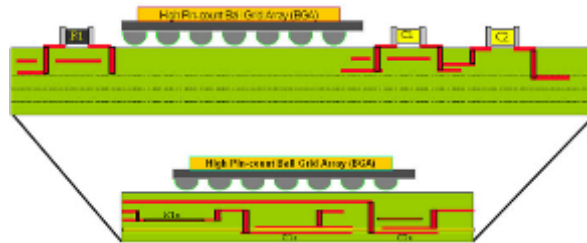

Figure 5 – Embedded Passives inside PCB³

Package-on-Package

The Package-on-Package (PoP) assembly method allows stacking of two components, one on top of another. BGAs are stacked together to provide a shorter signal path between two packages of BGA. This is commonly used to put a BGA containing the memory module, on top of another BGA which contains the microprocessor. The space where one BGA package occupies on the PCBA now contains two components, saving the space for one component.

The initial PoP assembly starts with a 0.65mm pitch BGA, placed on top of a 0.5mm pitch BGA. From 0.5/0.65mm, it evolves into 0.4/0.5mm (0.4mm bottom BGA / 0.5mm top BGA), then to 0.4/0.4mm (both top and bottom BGA at 0.4mm pitch). Regular PoP have a solder ball height spacing between the top and bottom BGA, as the top BGA is soldered onto the pads on top of the bottom BGA. Thru-molded via (TMV) PoP allows the top BGA to solder to vias that replace the pad on top of the bottom BGA. The overall thickness of the PoP after assembly is reduced.

PoP assembly can be performed with an in-line process flow, where the bottom BGA is placed onto the solder paste pads on the PCBA during SMT processing, and the top BGA is either solder or flux dipped then placed onto the bottom BGA. The solder joint between the top and bottom BGA on the PoP is formed at the same time while the PCBA is in the reflow oven. This utilizes existing the SMT machine with the addition of a solder or flux dip module. Nitrogen for reflow is generally required for 0.4/0.5mm pitch PoP. The success of the PoP is more subject to coplanarity of the top and bottom BGA, where at least 80um coplanarity is required. In-line process flow have been successfully used in very high volumes in manufacturing.

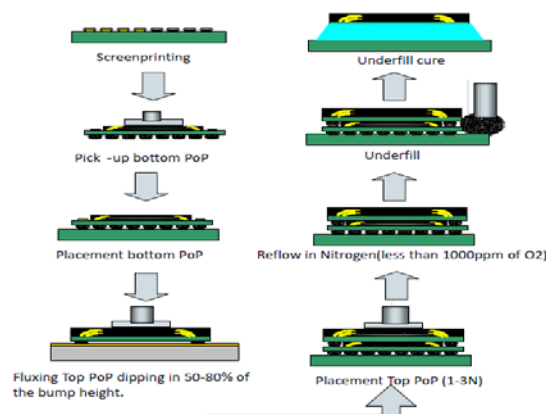

Figure 6 – PoP In-Line Process Flow

The other PoP assembly option is to do pre-stack. As the name implies, pre-stack will assemble the top and bottom BGA as a component off-line first, then the PoP is installed onto the PCBA as a component. This method is less subject to the coplanarity issue between top and bottom BGA. A customized metal tray is needed to hold the bottom BGA through the SMT machine during pre-stack. This requires manual handling for transferring the bottom BGA from its original tray package onto the customized metal tray. Nitrogen requirement for reflow is the same as the in-line process. Testing of the PoP component after pre-stack, before assembly to the PCBA also poses a challenge.

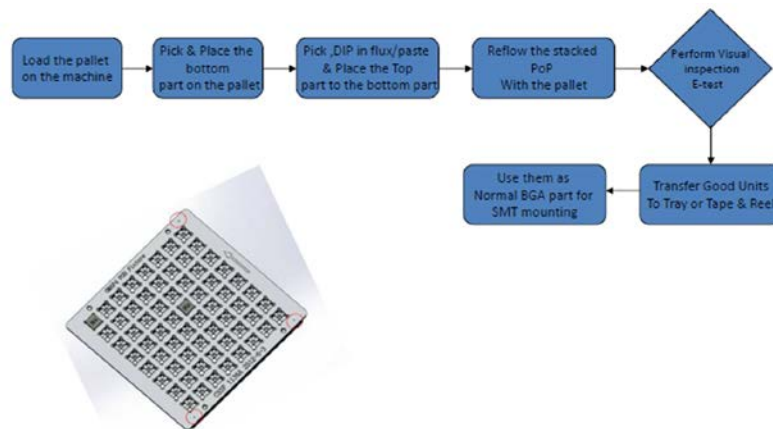

Figure 7 – PoP Pre-Stack General Process Flow

For the solder / flux dipping of the top BGA during the in-process or pre-stack process flow, either a rotary drum or linear squeegee type dipping station can be used. The actual type is dependent on the SMT machine supplier. They both work on the same principle to prepare a film of solder or flux at a controlled thickness.

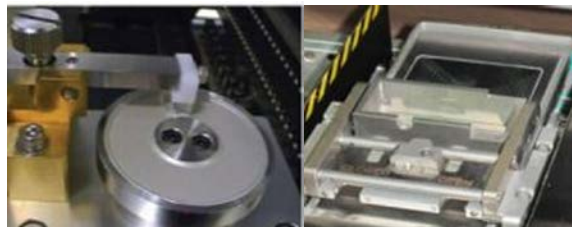

Figure 8 – Dipping Station: Rotary Drum (left), linear squeegee (right)

Advantages of PoP include:

- Miniaturization as PCB area for only one part is needed
- Allows direct electrical path between microprocessor and memory on the component level

Disadvantages of PoP include:

- Top and bottom part of a PoP must match together to avoid yield issues (co-planarity, warpage, CTE)
- Extra process steps required
- Extra cost for equipment
- May require nitrogen reflow

The recommended PoP assembly is the in-line process on the PCBA, using existing SMT machines with the addition of a dipping station inside the machine. This method lowers the total number of process steps involved, thus achieving lowest total cost.

To ensure a successful PoP assembly, there are several critical process controls to be implemented. The repeatability and

reproducibility for solder paste printing, and in-line solder paste inspection must be verified. The SMT machine placement must also have good repeatability and reproducibility. The flux height and flux volume at the dipping station should be checked once an hour. The SMT machine placement force for the top part must be set to a low setting and calibrated. The top and bottom part of the PoP is sensitive to moisture and we need to ensure that MSD control is strictly followed.

Cavity Assembly

The assembly method involves creating a cavity during the PCB manufacturing process. The cavity allows overall thickness reduction by allowing components to sit below the top layer of the PCB. There are many challenges with this assembly method, which we will discuss in further detail.

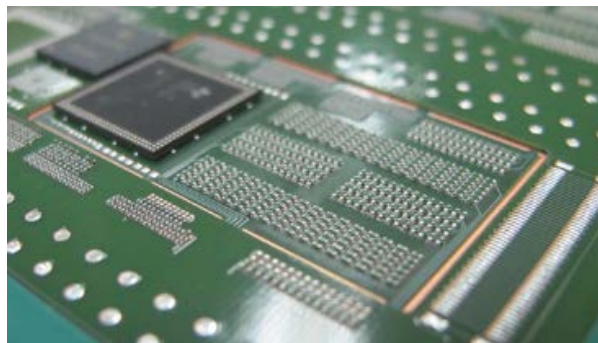

Figure 9 – Cavity Assembly

The cost of the PCB will increase due to the extra steps required to create a cavity, and to plate the pads inside the cavity.

To deposit solder paste into the cavity area, a special stencil is needed if doing one pass printing, or two separate stencils for double printing. The thickness tolerance of the PCB must be fully understood to design the correct pocket depth for cavity printing. This is to create a tight seal in the cavity area for proper printing.

If using the one pass printing stencil, the automatic stencil cleaner on the screen printer will not work due to the gap created by the pocket on the cavity stencil. Due to this reason and the tolerance of the PCB on cavity depth, the double printing method is preferred for cavity assembly.



Figure 10 – Automatic Stencil Cleaning Issue with One Pass

Double printing requires the use of two stencil printers. The first machine will host the stencil with the pocket to print the cavity area first. A slitted squeegee blade is needed to ensure the solder paste is deposited via the opening in the stencil. The slitted squeegee blade needs to have a front squeegee which is performing the actual printing, and a back squeegee to act like a pusher to ensure the front squeegee falls into the cavity.

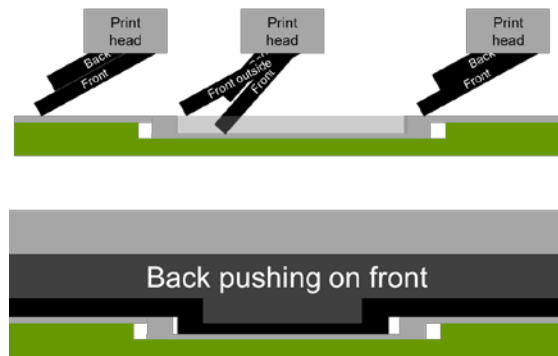

Figure 11 – Slitted Squeegee with front and back blade

After solder paste is deposited in the cavity area, the PCBA will go through the second stencil printing machine to print the regular PCBA surface. The cavity area will be blocked on the stencil.

The components in the cavity are placed by SMT machine by increasing the z-distance travel of the placement.

The addition of a stencil printer to the SMT line will require additional floor space to accommodate.

Future

Molded Interconnect Device

The 3D assembly method discussed previously uses a combination of rigid and flexible PCBA, or takes advantage of the z-axis by either adding components on top of each other (PoP), or reducing the PCB.

Molded interconnect device (MID) does away with traditional PCBA, but allows circuitry to exist on top of the injection molded plastic. The process involves injection molding of the plastic part with additives, laser activation of the artwork on the plastic part, then plating of copper and surface finish on the unit.

This creates a single layer trace on top of the plastic part. If a current assembly involves installation of a PCBA into a plastic enclosure, MID can eliminate the PCBA and have the component directly installed onto the plastic. To realize the full potential of MID, the assembly should be designed with MID taken into consideration to take advantage of the 3D aspect.

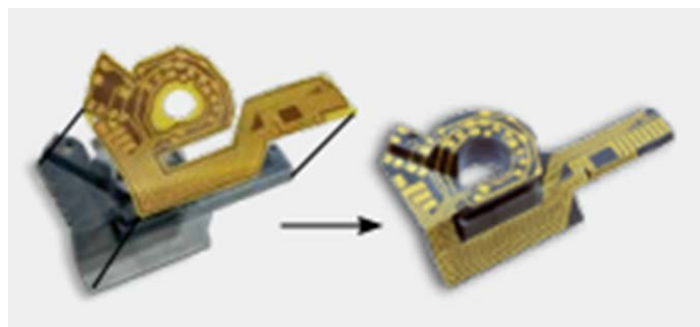

Figure 12 – Molded Interconnect Device⁴

3D Structural Electronics

3D plastic printing and 3D metal printing technologies exist now to print out plastic or metal parts based on CAD data, without any tooling involved.

Taking the 3D printing process one step further, researchers in Universities are looking to combine additive manufacturing and direct printing technologies to create 3D structural electronics.



Figure 13 – 3D Structural Electronics⁵

What will it take to go to 3D?

As we venture from 2D into 3D assembly, the infrastructure established for design and manufacturing of 2D assembly needs to be upgraded to handle 3D. There is currently no known CAD layout program that can handle a PCBA layout in 3D. Deposit of solder paste onto 3D surfaces need to be developed. Placing SMT components onto 3D surfaces, similar to current processes for 2D, requires development from the SMT machine supplier. The placement involves not only the machine itself, but the associated software to generate 3D placement programs similar to current processes for 2D. Automated inspection for 3D assembly needs to be developed. This includes visual and x-ray capabilities.

Summary

In the past, to achieve a 3D assembly at the PCBA level, we used connectors or various assembly methods to perform B2B or B2F connection. To reduce component count on the PCB, we can use buried capacitance or as it currently evolves to embedded passives or actives to spare valuable board space.

From the assembly level, we look at PoP and cavity assembly in finer detail. PoP allows stacking of two components that will occupy only space for one component on the PCBA. Cavity assembly allows a reduction of thickness by recessing components below the top layer of the PCB.

Looking toward the future, we look at molded interconnect device and 3D structural electronics. There are many challenges, both in design of a 3D circuitry, and the manufacturing process required for 3D.

Reference

1. Courtesy: Harting har-flex PCB connectors
2. Courtesy: KSG
3. Courtesy: Cambridge PCB
4. Courtesy: LPKF, Harting AG
5. Courtesy: Keck Center, University of Texas at El Paso



3D Assembly Process A Look At Today And Tomorrow

**David Geiger, Georgie Thein
Advanced Engineering Group**

**Flextronics International Inc.
847 Gibraltar Drive, Milpitas, CA 95035**



Introduction

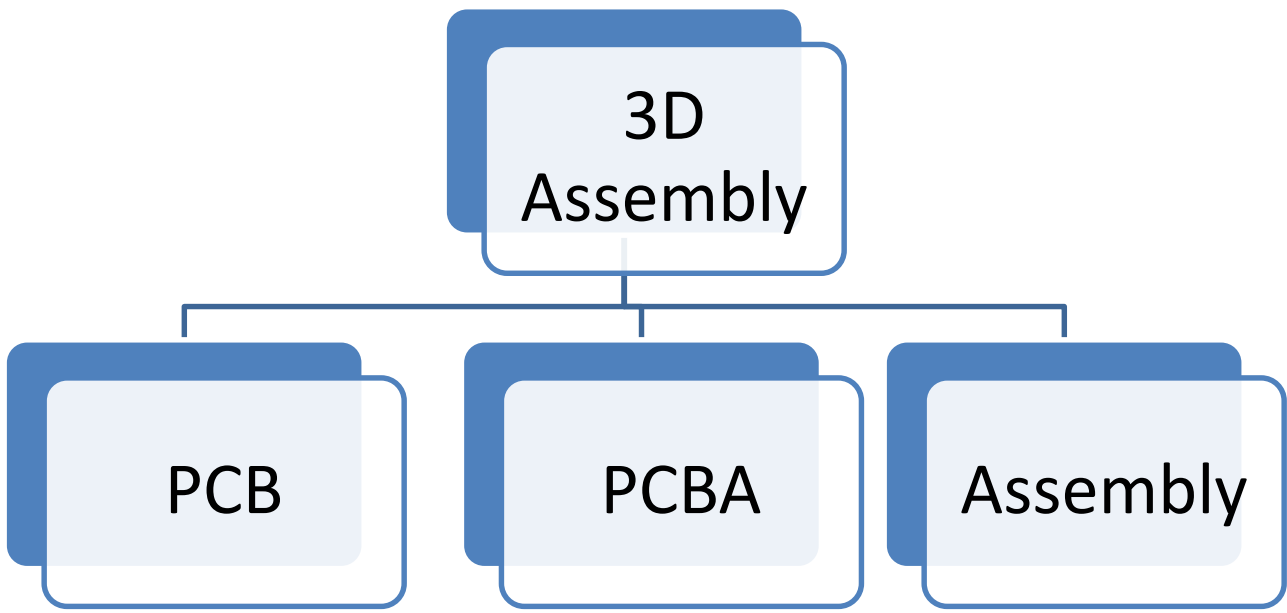



Assembly Level

- On assembly level, to interconnect PCBAs, traditionally have used connectors.
- Connectors available in thru-hole (PTH) or SMT version
- There has been much much usage throughout the industry



Assembly Level

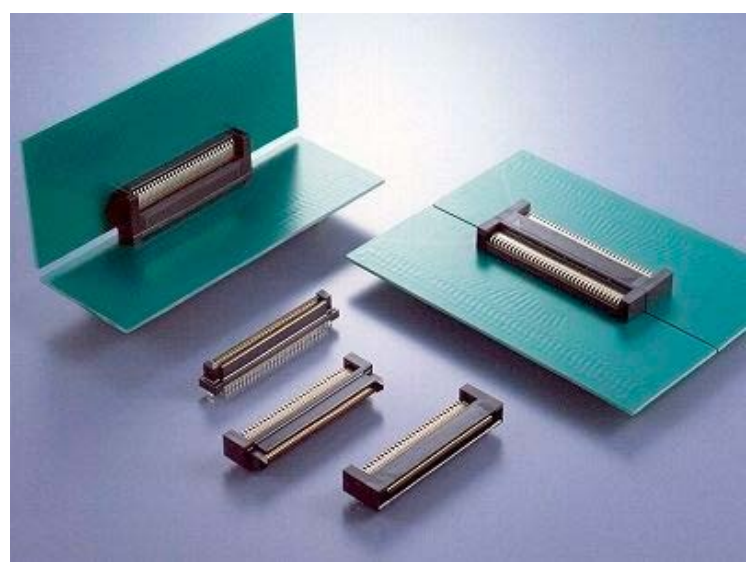
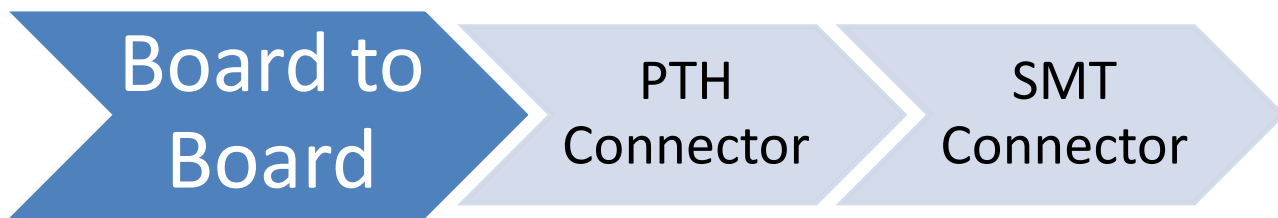

Courtesy: Japan Aviation Electronics Industries



Courtesy: Harting har-flex PCB connectors



Assembly Level

- Flexible printed circuit (FPC) allows various orientation of PCBAs to interconnect
- Board to FPC can be done via connector or direct attach
- Direct attach includes hot bar soldering, ACF/ACP
- Rigid-flex integrates rigid and flexible PCBA together



Assembly Level

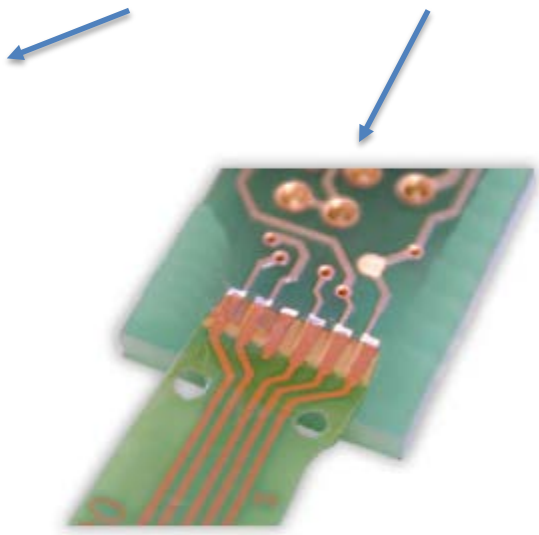
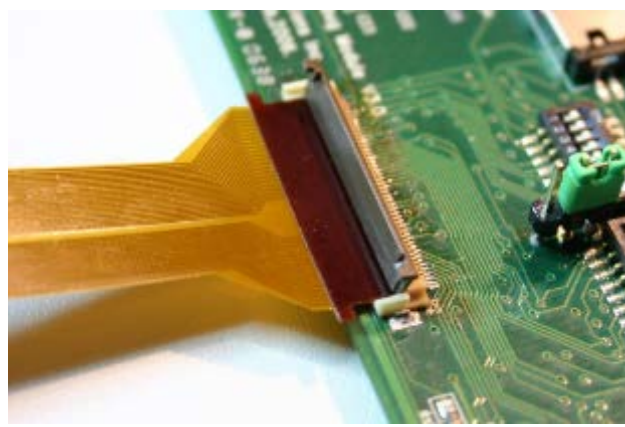
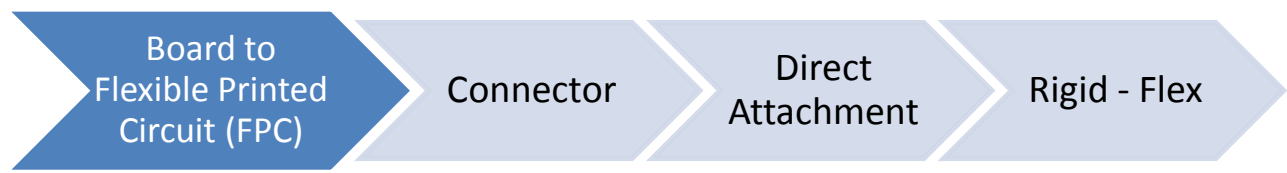

Courtesy: Hartmann

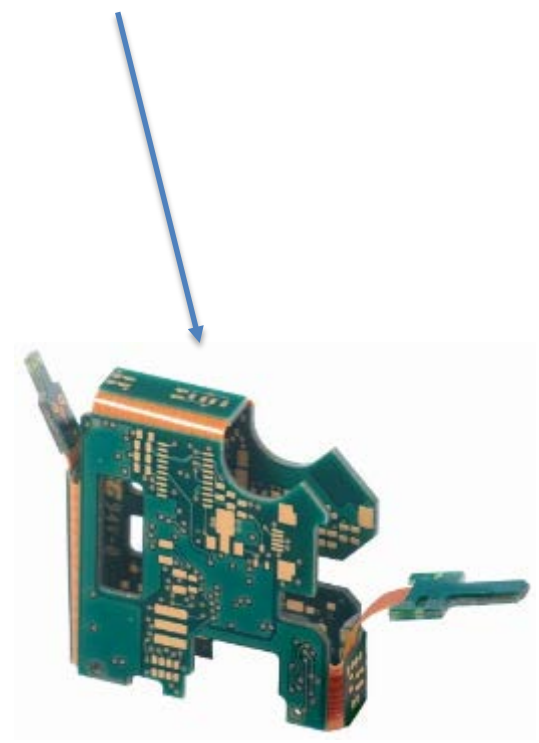

Courtesy: KSG



PCB Level

- On PCB (bare fab), to reduce the number of components to be installed on the surface, various methods have been investigated.
- Buried capacitance provides a single capacitance value across the parallel plane inside the PCB.
- Embedded passives place resistors and capacitors with different values inside the PCB
- Embedded actives place chip level components inside the PCB



PCB Level



EMBEDDED CAPACITANCE - PLANAR CONSTRUCTION

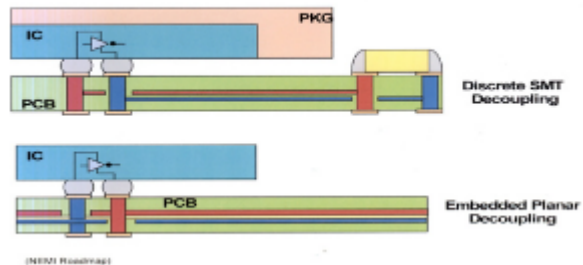

Courtesy: Cambridge PCB

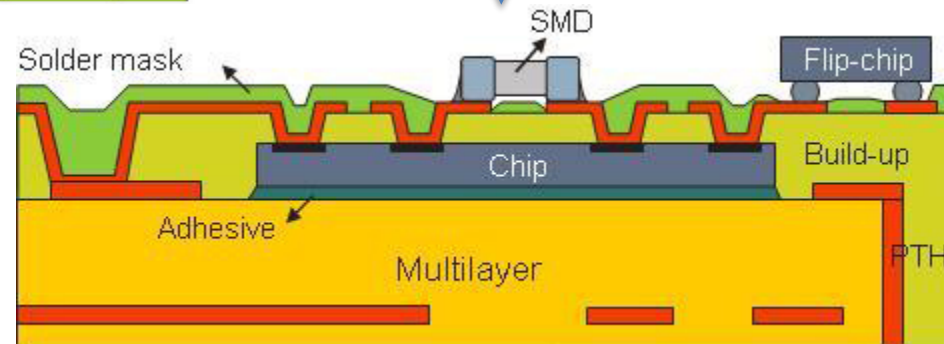
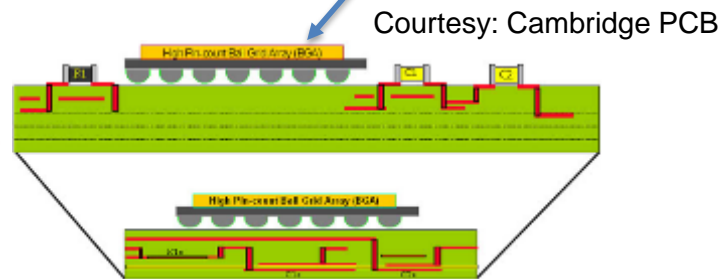

Courtesy: Pulsonix

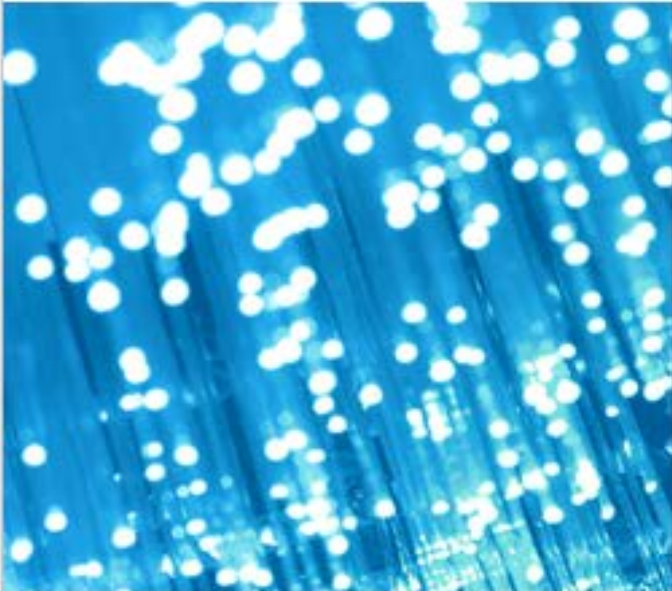

PoP and Cavity



- On assembly technology, current assembly methods utilize the planar surface in X and Y direction
- Package-on-Package (PoP) and cavity assembly take advantage of the Z direction
- PoP allows stacking of two components, one on top of another.
- Cavity assembly create a “cavity” in the PCB to allow components to be placed beneath the board top surface level



PoP

- PoP allows stacking of two BGAs, one on top of another.
- PoP component range from 0.5/0.65mm pitch, 0.4/0.5mm pitch, 0.4/0.4mm pitch (bottom / top)
- TMV PoP further reduce overall thickness after assembly



PoP

- Advantages:
 - Miniaturization as PCB area for one part is only needed
 - Allows direct electrical path between microprocessor and memory on component level
- Disadvantages:
 - Top and bottom part must match together to avoid yield issue (co-planarity, warpage, CTE)
 - Extra process steps required
 - Extra cost for equipment
 - May require nitrogen reflow (additional cost)



Example of top and bottom component for PoP

CBS (S-PBGA-N547)

PLASTIC BALL GRID ARRAY

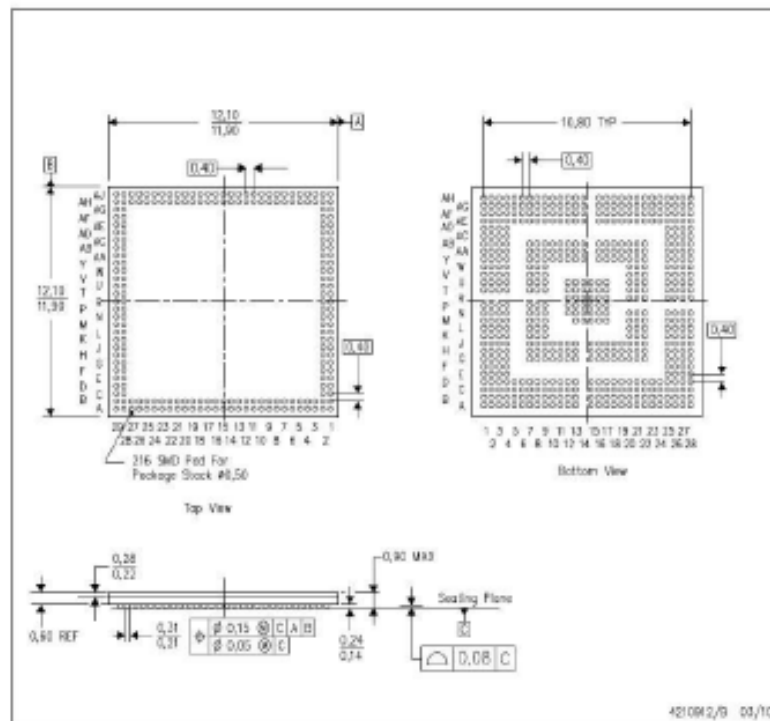

- NOTES:
- All linear dimensions are in millimeters. Dimensioning and tolerancing per ASME Y14.5M-1994.
 - This drawing is subject to change without notice.
 - Flux chip application only.
 - Po-Free die bump and solder ball.

216-ball FBGA

Solder ball: Lead free (Sn-Ag-Cu)

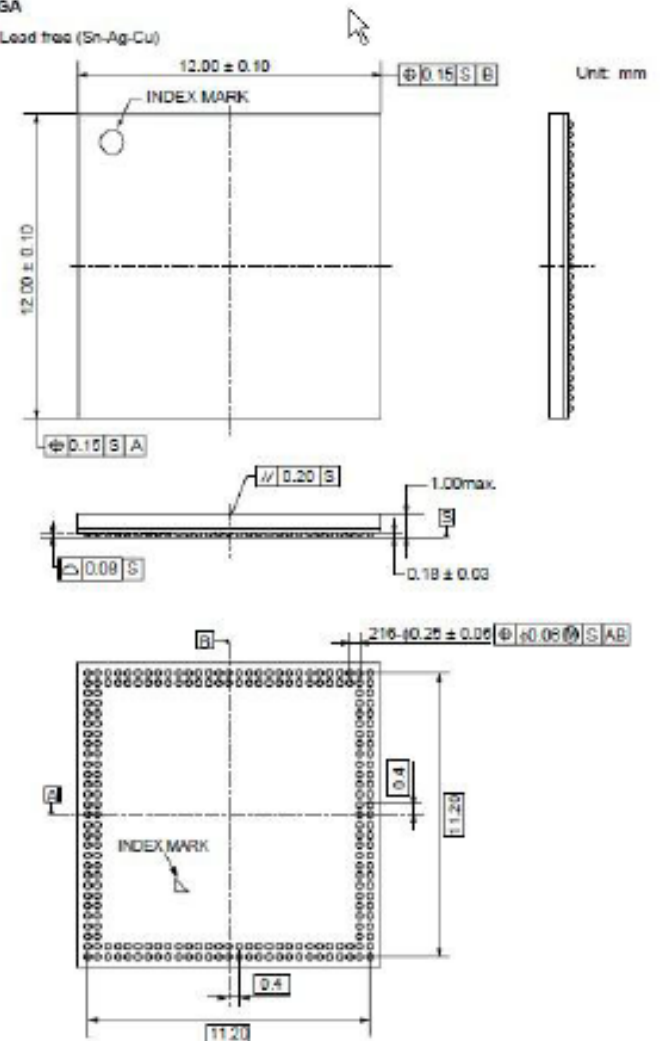



Shadow moiré images for PoP Top component

30	2.4	<p>Resolution: 10.0mil</p>	200	1.5	<p>Resolution: 11.0mil</p>
108	2	<p>Resolution: 10.0mil</p>	150	1.5	<p>Resolution: 11.0mil</p>
150	1.7	<p>Resolution: 10.0mil</p>	100	1.8	<p>Resolution: 11.0mil</p>
200	1.5	<p>Resolution: 10.0mil</p>	30	2.9	<p>Resolution: 12.0mil</p>
250	1.8	<p>Resolution: 10.0mil</p>			



Shadow moiré images for PoP Bottom component

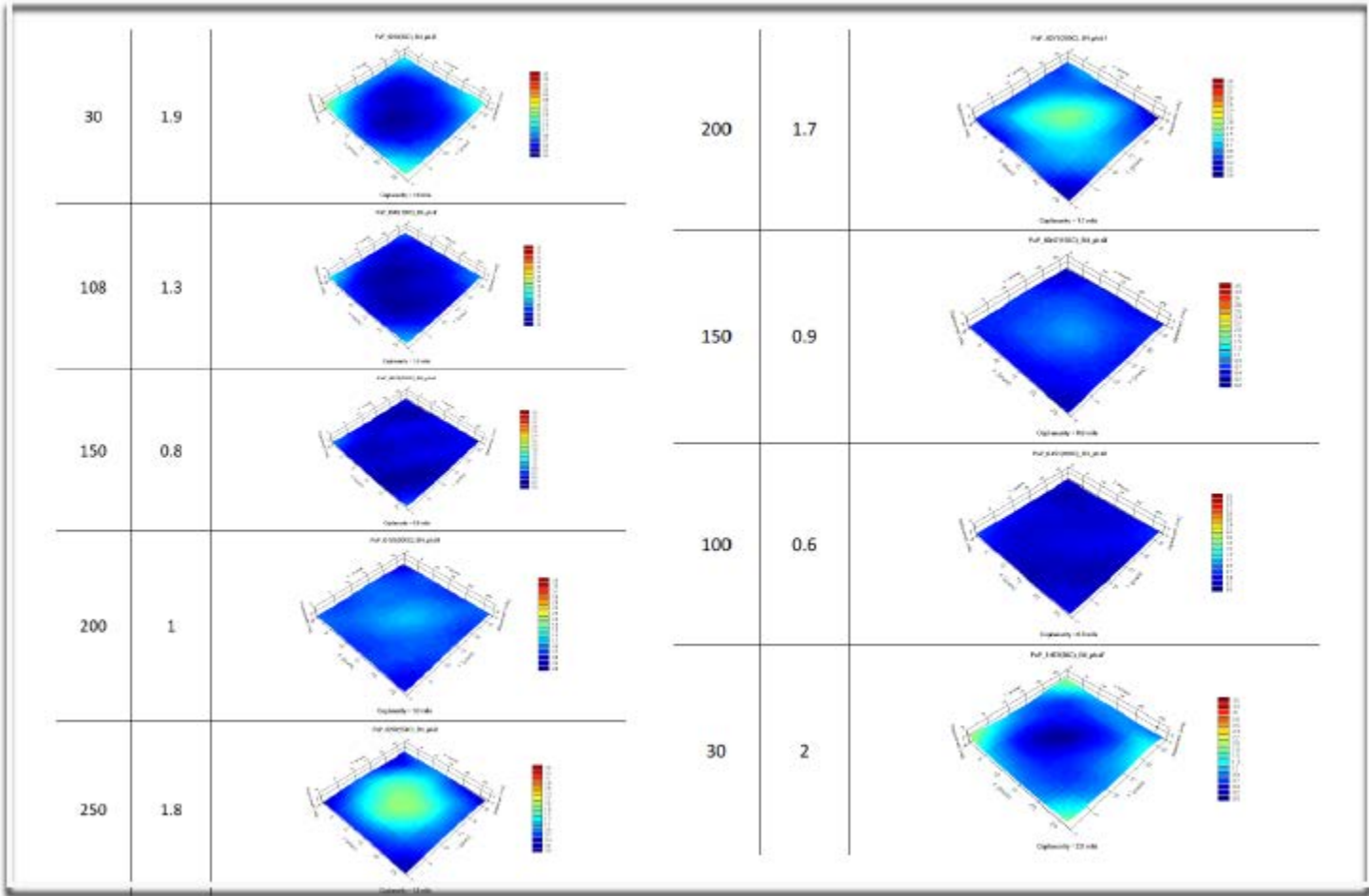



PoP Process

	Advantages	Disadvantages
In-line process	<ul style="list-style-type: none">Fast and automatedMinor investments requiredTested on more than 100 million assemblies in our company	<ul style="list-style-type: none">At least 80um coplanarity is requiredNitrogen is required for 0.4/0.5mm pitch or smaller component
Pre-stacking	<ul style="list-style-type: none">Less sensitive for coplanarity	<ul style="list-style-type: none">Lots of manual handlingNitrogen might be excluded for main board but is required in the stackingTest issues and extra testing is required



PoP Process Flow (0.4/0.4mm & 0.4/0.5mm TMV PoP)

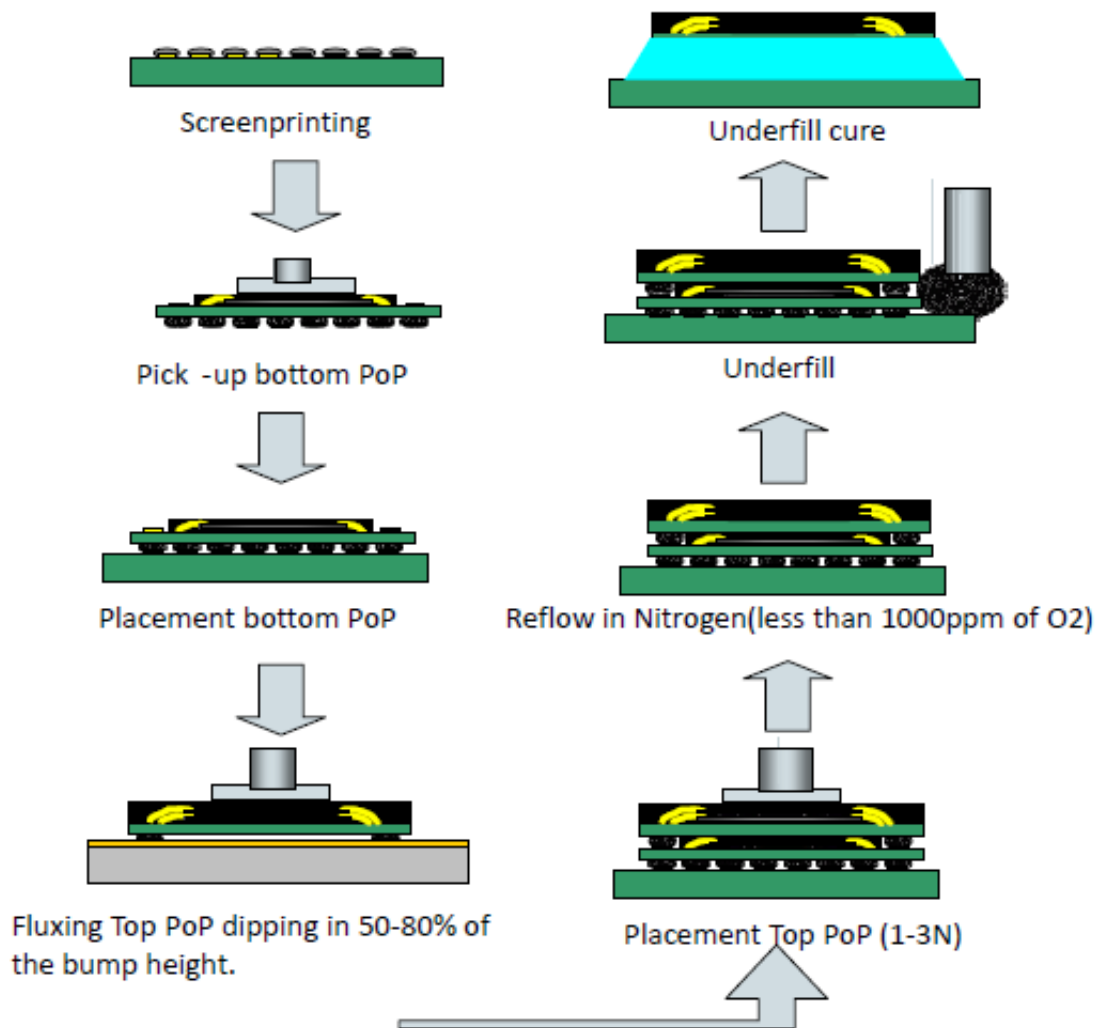



PoP Placement and Dipping

A dipping station is needed to apply solder paste or flux to the solder balls on the top component. Two types of dipping station exist depending on SMT machine supplier

- Rotary drum
- Linear squeegee type

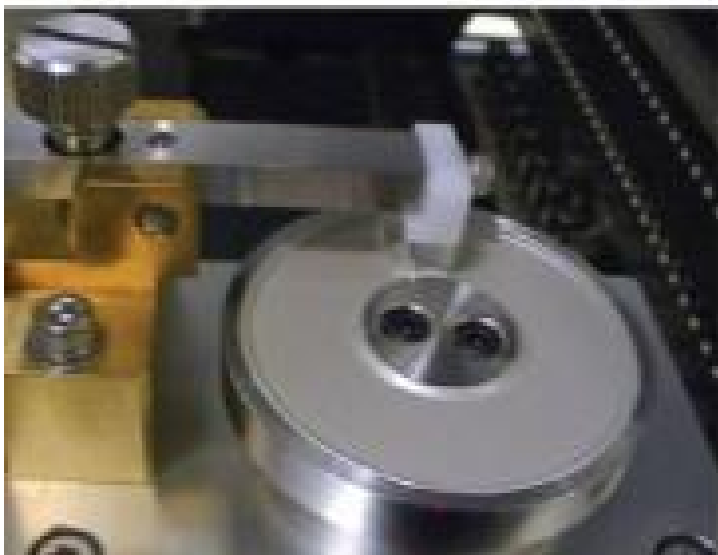



PoP Pre-Stack General Process Flow

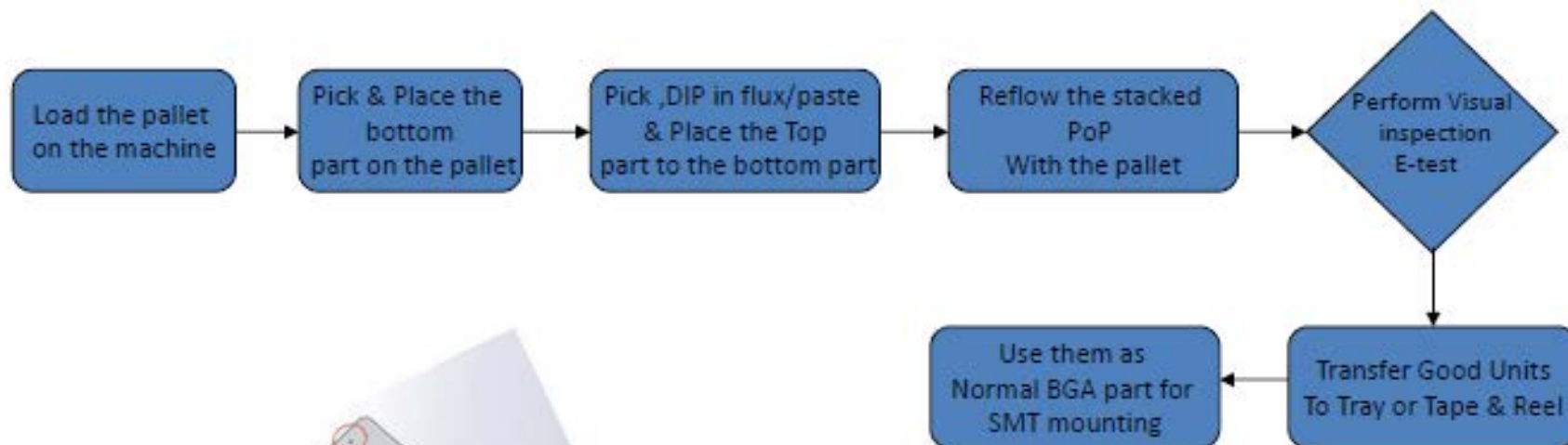



PoP Pre-Stack Fixture Design



Result:

- PoP Top & Bottom part are properly stacked without gaps in between them.
- No signs of ball drops or fall off on the bottom part of the PoP
- Nitrogen is required to prevent Oxidation of balls during reflow



PoP

Our recommended process is the inline PoP process on the main board, using Surface Mount lines lowering the amount of process steps and achieving lowest total cost.

General Controls to have in place for PoP assembly:

- Cp and Cpk for printing and inline SPI (0.4mm pitch)
- Cp and Cpk for placement
- Check flux height and flux volume once an hour
- Low placement force and ensure it is calibrated
- MSL level control critical to avoid opens



Cavity PCB and Assembly

- Thickness reduction is the main driver for potentially using cavity PCBs and cavity assembly
- If a certain area of the PCBA is higher than other areas of the PCBA, some components could be placed in a cavity and thereby reduce the overall thickness.
- Cavity design needs to be carefully planned and there are many challenges with using this kind of design.

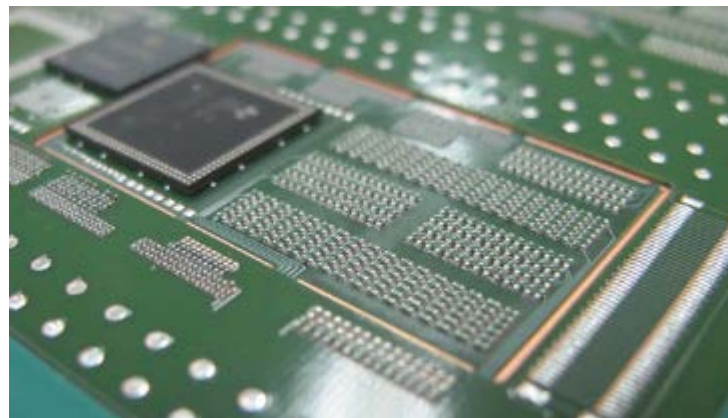



Cavity PCB and Assembly

- Advantage:
 - Potential thickness reduction with a well thought out design
- Disadvantages:
 - More advanced PCB required (extra cost)
 - Extra process steps required, double printing or other method of applying solder/solder paste
 - Extra cost for equipment
 - Nitrogen reflow when using CSPs equal to and below 0.4mm pitch



Cavity PCB Fabrication Process



Inner layer DES as standard production board



Plating resist printing / exposure / developing

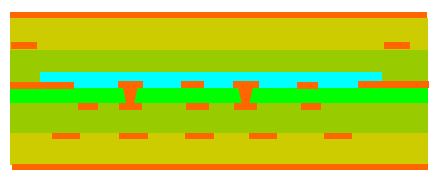

Sequential lamination as standard production board

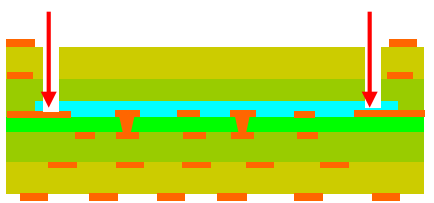

CO2 laser cut out cavity area

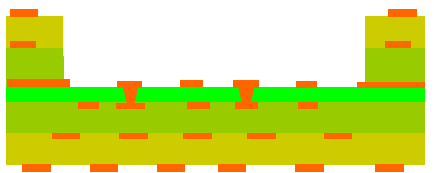

FR4 decap and plating resist removal

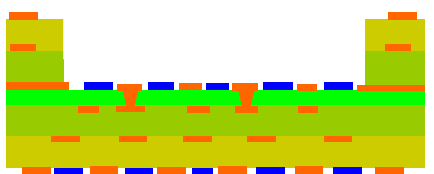

Cavity and outer layers DES and SM together



PCB, Stencil, and Squeegee Design

There are many challenges with cavity printing and most are related to PCB, stencil, and tooling tolerances.

1. The PCB thickness tolerance is +/- 10% and with a 0.40mm cavity, this gives a copper/copper tolerance of 0.040mm.
2. The PCB copper to copper layer X and Y tolerance is 0.075-0.1mm. Dedicated fiducials are recommended for the top and cavity layers when using advanced designs.
3. The stencil cavity thickness tolerance is around 0.010mm.
4. Automatic stencil cleaning in the printer is a concern and creates some design limitations especially when trying to print on top and cavity layers at the same time with one print step.
5. Stencil vs. Squeegee matching.



PCB, Stencil, and Squeegee Design

The PCB thickness tolerance excluding solder mask is +/- 10% and with a 0.40mm cavity (Z^1), this gives a copper/copper height difference tolerance of 0.040mm(1.5mil) between top and cavity layers. With a 75um thick stencil, this is a very big tolerance.

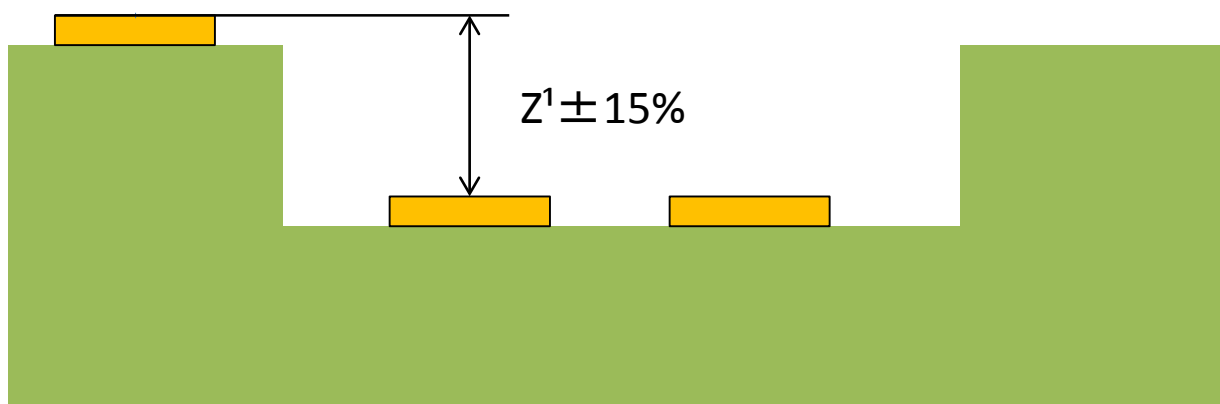



PCB, Stencil, and Squeegee Design

The PCB copper to copper layer X and Y tolerance 0.075-0.1mm. Dedicated fiducials are recommended for the top and cavity layers when using advanced designs.

- For smaller apertures this will require a double screen printing process.

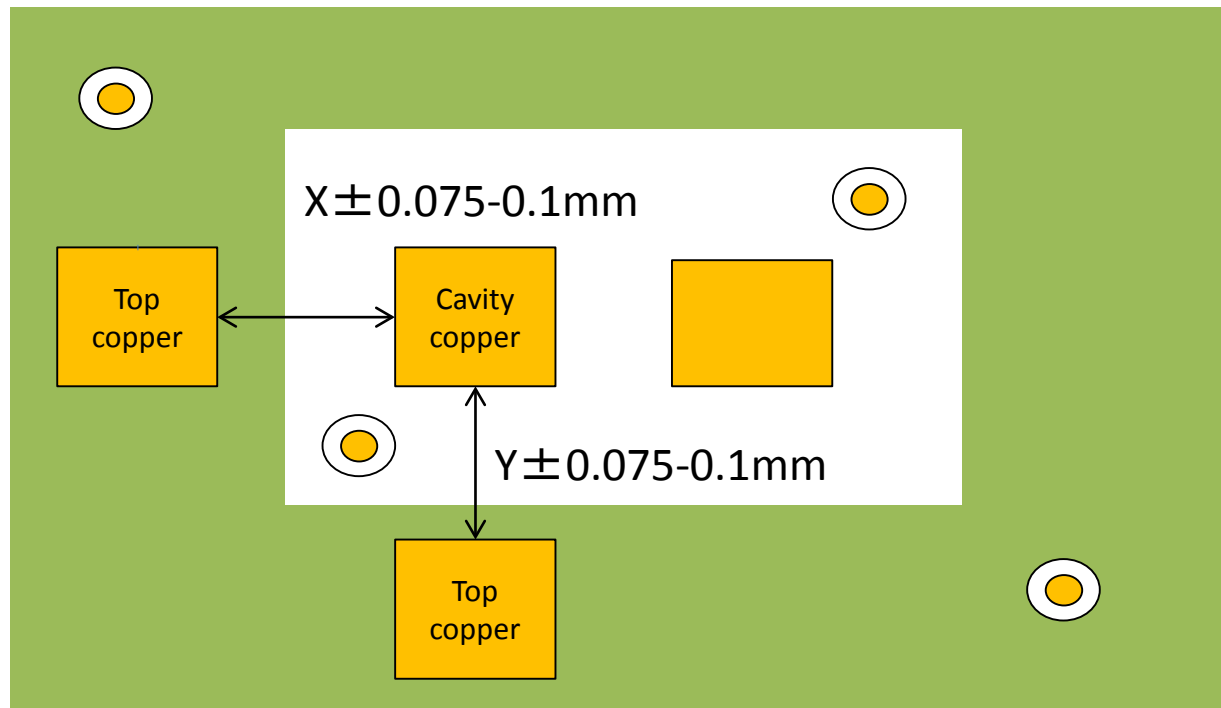



PCB, Stencil, and Squeegee Design

- Automatic stencil cleaning in the printer is a concern and creates design limitations especially when trying to print on top and cavity layers at the same time.
- Due to stencil cleaning and Z tolerances for the PCB and stencil, a double screen printing process is recommended.





PCB, Stencil, and Squeegee Design

- The stencil cavity and squeegee need to be carefully matched and we use so called slitted squeegees to enable automatic stencil cleaning.
- If a normal squeegee is used, stencil cleaning will not work well as solder paste will remain in the cavity and it will smear the bottom of the stencil. The cleaning fluid will also be mixed with the solder paste. The solder paste release will be very difficult to control.

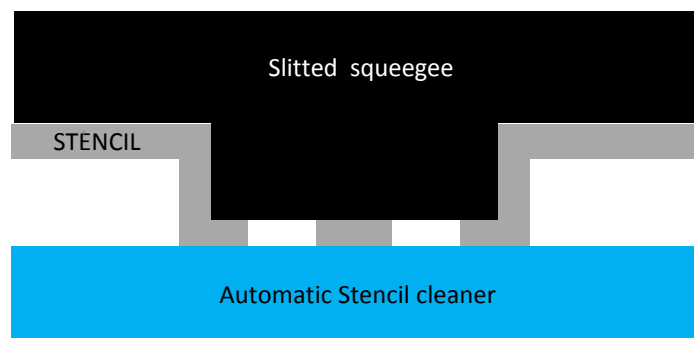
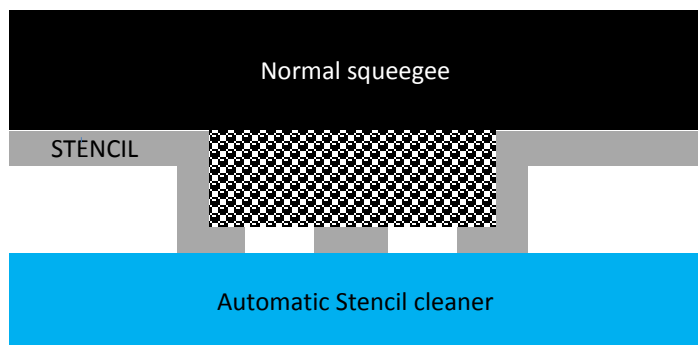



PCB, Stencil, and Squeegee Design

The slitted squeegee contains 2 main parts and both are matched to the cavity opening

- Front squeegee is where the paste printing is and it acts like a normal squeegee outside the cavity. Once it reaches the cavity it will fall into the cavity and print this area.
- Back squeegee acts like a pusher to ensure that enough tension is applied so that the front can fall into the cavity.

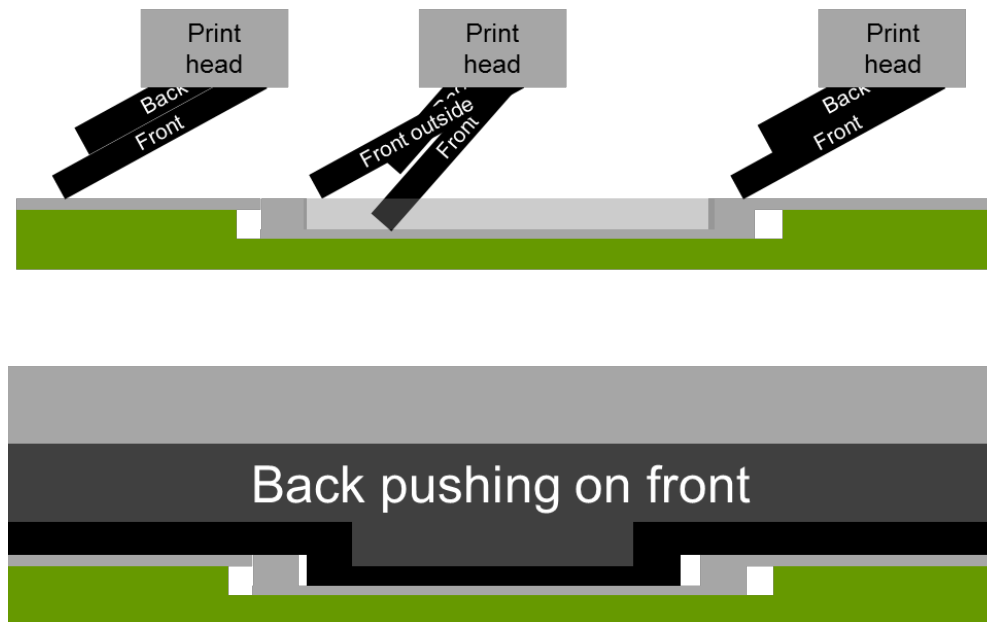



Cavity Assembly Process

- Two possible process flows have been evaluated for cavity printing and assembly
 - Double layer printing: Top layer and cavity layer printed at the same time. This process will only work on more simple designs due to the PCB fabrication tolerances.
 - Single layer printing: The cavity layer is printed 1st with a 3D stencil and the top layer is printed 2nd in a separate printer.
- Using two printers adds extra cost but with the current tolerances involved, this is in most cases the only safe process flow.

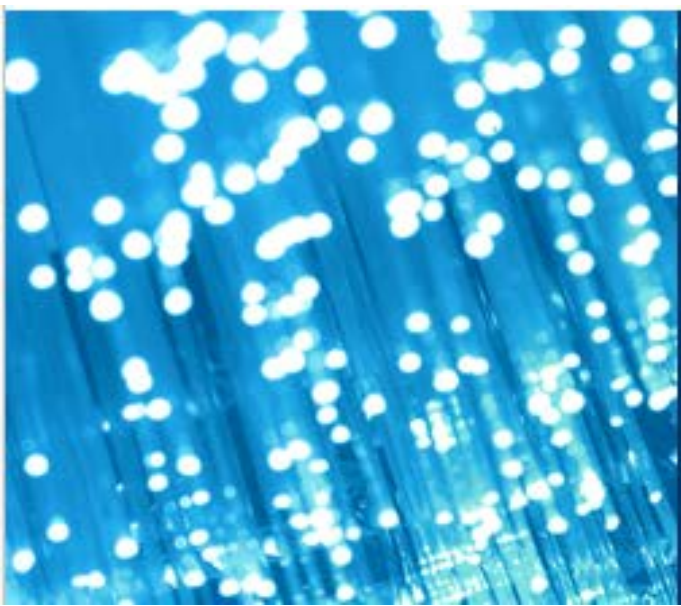

Looking toward the future



Molded Interconnect Device

- Technology to add circuit traces to injection molded plastic parts to create a 3D unit.
- The process involves:
 1. Injection molded plastic with additives
 2. Laser activation of the artwork on the unit
 3. Plating of the copper and surface finish on the unit

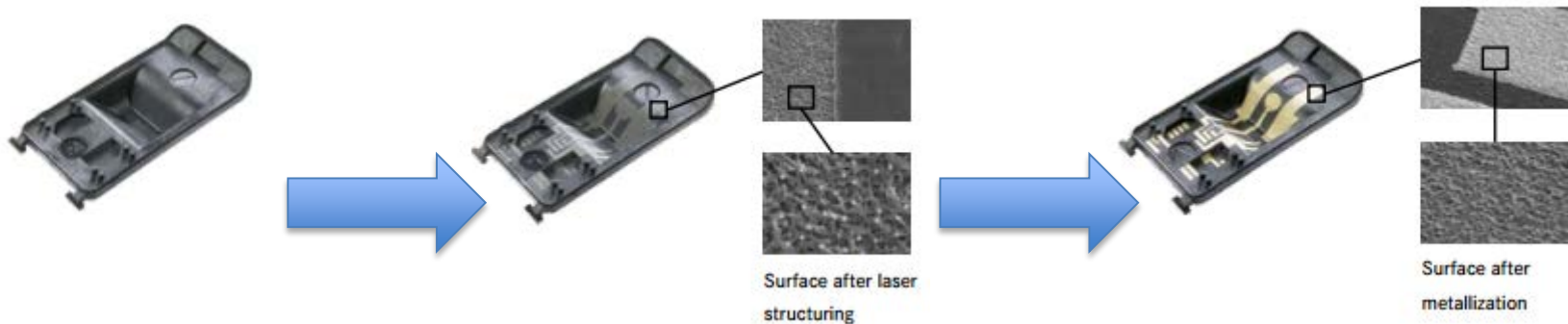

Courtesy: LPKF



Molded Interconnect Device

- Advantages:
 - Reduce number of component and dimension
 - Allow circuitry in 3 dimension
 - Ease of design change on circuit
- Disadvantages:
 - Single layer circuit
 - Need to design circuitry in 3D, not standard software
 - Automated assembly challenges
 - Automated inspection challenges



Molded Interconnect Device

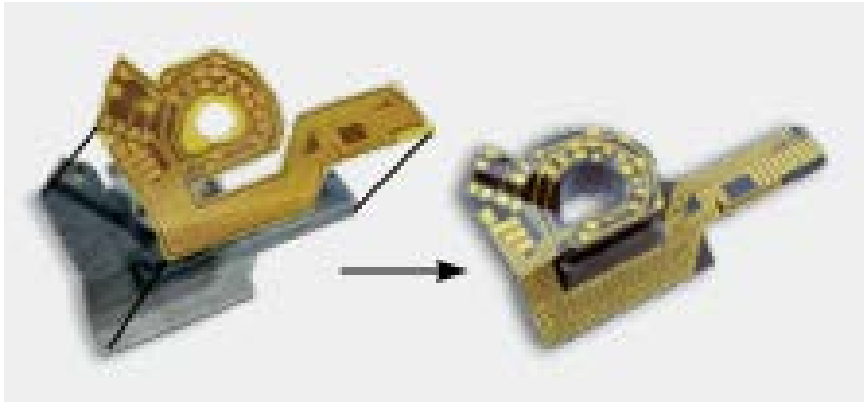

Combining FPC and plastic component into one unit

Courtesy: LPKF, Harting AG



Steering wheel controls

Courtesy: LPKF, TRW Automotive for BMW



3D Structural Electronics

- Research in Universities combining Additive Manufacturing and Direct Printing technologies.
- Additive Manufacturing includes polymer-based and metal-based.

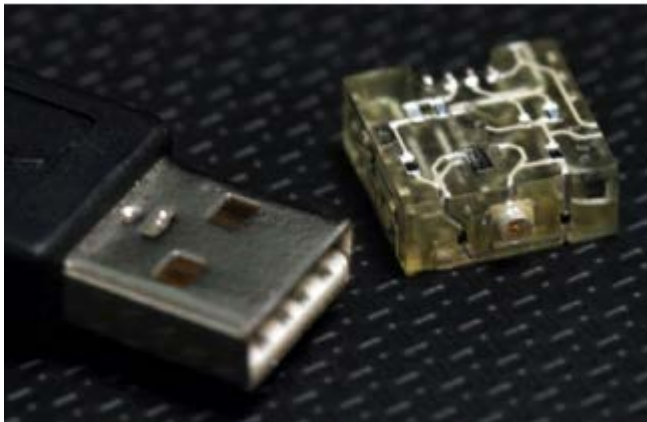

Courtesy: Keck Center, University of Texas at El Paso



Thank You