

# Component Reliability After Long Term Storage

---

R. R. Madsen

## ABSTRACT

Each year the semiconductor industry routes a significant volume of devices to recycling sites for no reliability or quality rationale beyond the fact that those devices were stored on a warehouse shelf for two years. This study identifies the key risks attributed to extended storage of devices in uncontrolled indoor environments and the risk mitigation required to permit safe shelf-life extension. Component reliability was evaluated after extended storage to assure component solderability, MSL stability and die surface integrity. Packing materials were evaluated for customer use parameters as well as structural integrity and ESD properties. Results show that current packaging material (mold compound and leadframe) is sufficiently robust to protect the active integrated circuits for many decades and permit standard reflow solder assembly beyond 15 years. Standard packing materials (bags, desiccant, and humidity cards) are robust for a 32 month storage period that can be extended by repacking with fresh materials. Packing materials designed for long term storage are effective for more than five years.

# CONTENTS

<b>ABSTRACT</b>	<b>1</b>
<b>LIST OF FIGURES</b>	<b>3</b>
<b>INTRODUCTION</b>	<b>4</b>
<b>BACKGROUND</b>	<b>4</b>
<b>PROCEDURE</b>	<b>4</b>
<b>EXCLUSIONS</b>	<b>5</b>
<b>RISK ASSESSMENT</b>	<b>5</b>
<b>DEVICE SPECIFIC RISKS</b>	<b>5</b>
<b>PACKING MATERIALS SPECIFIC RISKS</b>	<b>6</b>
<b>DEVICE SAMPLES INCLUDED IN THE EVALUATION</b>	<b>7</b>
<b>PACKAGE SPECIFIC TESTING</b>	<b>8</b>
<b>LEAD SURFACE EXAMINATION AND INTERNAL VISUAL</b>	<b>8</b>
<b>SOLDERABILITY TEST</b>	<b>9</b>
<b>MSL VERIFICATION TEST</b>	<b>9</b>
<b>EXAMINATION AND PHOTOGRAPHS OF PACKING MATERIALS</b>	<b>10</b>
<b>TRIBOCHARGE EVALUATION TOOL</b>	<b>11</b>
<b>PBFT – PEEL BACK FORCE TOOL</b>	<b>12</b>
<b>SUMMARY OF RESULTS</b>	<b>13</b>
<b>CONCLUSION</b>	<b>13</b>
<b>ACKNOWLEDGMENTS</b>	<b>14</b>
<b>GLOSSARY OF TERMS</b>	<b>15</b>

## LIST OF FIGURES

Figure 1 - Optical Micrograph of 74AC11175DWR device showing representative lead appearance.....	8
Figure 2 - Optical Micrograph of 74AC11175DWR representative device lead .....	8
Figure 3 - FESEM Micrograph of 74AC11175DWR representative device leads - Bottom side of package .....	8
Figure 4 - FESEM Micrograph of 74AC11175DWR representative of device lead - Bottom of package .....	8
Figure 5 - Representative EDS spectrum of 74AC1175DWR lead surface showing typical elements present.....	8
Figure 6 - Optical Micrograph of 74AC11175DWR representative die overview showing no abnormalities.....	9
Figure 7 CSAM image of TPS2201 prior to moisture/reflow simulation. No significant delamination observed. ....	9
Figure 8 CSAM image of TPS2201 post Moisture/reflow simulation. Minor leadframe delamination observed. ....	9
Figure 9 DAC7612U devices in a moisture barrier bag. ....	10
Figure 10 74ACT11374DWR devices in original sealed pizza box.....	10
Figure 11 TSC2101IRGZR devices in original sealed pizza box.....	10
Figure 12 GD75232DWR devices in original sealed moisture barrier bag.....	11
Figure 13 TSC2101IRGZR devices in original sealed moisture barrier bag.....	11
Figure 14 TSC2101IRGZR devices in original tape and reel with 1 desiccant and moisture indicator labels.....	11
Figure 15 ESD Analyzer with Faraday cup and voltage field meter. ....	11
Figure 16 Peel-Back Force Test (PBFT) System.....	12
Figure 17 PBFT screen shot.....	12
Figure 18 Less than 20 volts detected during measurement of the static charge generated during peel back testing.....	12

## INTRODUCTION

This paper defines the risk factors associated with extended storage of plastic encapsulated integrated circuits in a warehouse (uncontrolled indoor environment) and the materials and practices required to assure the quality and reliability of the devices to the end user.

## BACKGROUND

It is not uncommon in the electronics industry to specify a maximum time interval from device manufacture to shipment and receipt by the customer. The origins of date code age restrictions are not well documented, but it is probable that limitations of the packing materials for moisture sensitive components and post storage solderability of SnPb or Sn finishes contributed to the concerns of customers that led to the shelf life restrictions.

Prior to 1995, the U. S. Military specified electrical retest of devices if a 3 year date code window was exceeded. In 1995, the military specification that mandated electrical retest after 3 years was revised and that requirement was removed entirely. The military now prohibits date code restrictions on component orders.<sup>4</sup>

A comprehensive evaluation of Long Term Storage devices was started in 2004 by engineers in Dallas and Freising, utilizing both current devices and devices stored for >2 years in a warehouse environment. That study which included ATE re-verification of electrical performance, concluded that no reliability or quality issues would result from storage of devices well beyond a 5 year period.<sup>2</sup>

## PROCEDURE

This study evaluated twenty devices packed in tubes or tape and reel that had been stored in a warehouse environment (<40°C and <90% RH) for periods of time ranging from two to seventeen years. The acronym LTS (Long Term Storage) is used to identify this aged material.

Packing materials were examined for signs of deterioration – this included tribocharging tests on clear tubes, black conductive tubes, and the cover tapes on T&R to evaluate the effectiveness of topical antistats. The “as opened” status of humidity indicator cards was noted and the cards were placed in a humidity monitored environment to test for functionality. Paper labels were examined for legibility and adhesion. Peel force testing was conducted on T&R. All packing materials were representative of the vendors and materials used at the time of manufacture.

The devices contained in the packing materials were carefully examined for signs of deterioration. Leads and pads of ten devices were examined microscopically and with SEM for any signs of corrosion or contamination. The surface areas of the leads were evaluated with EDS for any foreign material. Moisture/reflow testing verified MSL performance.

## EXCLUSIONS

Devices with a NiPdAu lead finish were the primary focus in this evaluation. Other lead finishes exhibited satisfactory solderability after simulated LTS; however, this study did not include materials such as matte tin or solder bumps.

## RISK ASSESSMENT

### DEVICE SPECIFIC RISKS

Risk	Risk Mitigation
Device functionality and parametric performance after extended periods of shelf storage.	No failure mechanisms have been identified that would compromise the electrical performance or circuit reliability of LTS devices. HTOL and HTSL qualification data provides the best estimate of parametric performance over time. Devices are biased during HTOL testing – this is worst case compared to unbiased storage.  FIT rates for Analog products have been in single digits for the past decade. This assures us that biased and unbiased devices would remain within data sheet limits far beyond the design life of the device.
Exposure to the ambient atmosphere for extended periods of time may oxidize the lead surface impacting solder wetting during assembly.	Aging studies have shown that NiPdAu lead finish devices pass solderability requirements beyond 8 years <sup>1</sup> . Actual testing of LTS devices indicates that storage for 15 years does not compromise solderability <sup>2</sup> .
Moisture absorbed in the epoxy matrix of devices categorized as MSL 2 to 6 could vaporize during reflow solder assembly and crack the package.	Devices targeted for LTS are packed in special metallized bags that are sealed with desiccant and a HIC. Moisture diffusivity of the MBB has been measured <sup>3</sup> and devices are transferred to new bags with fresh desiccant on a periodic basis.
Devices stored for extended periods may exhibit corrosion of bond pads or interconnect metallization.	Package qualifications include autoclave tests to evaluate the effect of moisture on die metallization (Galvanic corrosion). Devices routinely pass high temperature and humidity testing, which consists of 240 hours of autoclave at 121° and 100% RH which would translate to >7 years at 55°C and 60% RH and over 10 years at lower temperatures.
Devices that incorporate non-volatile memory may suffer data retention issues after long	Routine device qualifications include data retention tests performed at elevated temperatures. Existing data assures

Risk	Risk Mitigation
storage intervals.	us that biased and unbiased devices would maintain data integrity far beyond the design life of the device.

## PACKING MATERIALS SPECIFIC RISKS

Risk	Risk Mitigation
<p>The static dissipative properties of tubes or tape and reel may degrade over time resulting in potential ESD damage to LTS devices.</p>	<p><b>Tubes:</b> Tribocharge testing was conducted on LTS conductive and static dissipative tubes. Comparisons with fresh tubes from stock indicate device charge generation in aged tubes was comparable to new tubes.</p> <p><b>Tape and Reel:</b> Static field meter data taken during detape operations indicate that no significant tribocharging occurs on LTS sample reels.</p> <p>Carrier tape pull testing indicated that the LTS reels require no special handling or adjustments to detape tooling during assembly.</p>
<p>Storage bags may leak, allow moisture to enter, and cause problems for MSL.</p>	<p><b>MBB:</b> A breach of the MBB seal would be detected with a color change of the HIC and appropriate disposition of contained material.</p> <p>Extended storage bag manufacturer's data supports 5 year storage capability. Independent validation of Water Vapor Transmission Ratio (WVTR) for extended storage bags (5 years) was conducted at a contract lab<sup>5</sup>.</p>
<p>Label adhesives may fail or the ink marking could fade making lot history or device identification difficult.</p>	<p>Evaluation of material samples indicate no degradation in legibility or label adhesion after &gt;17 years.</p>

## DEVICE SAMPLES INCLUDED IN THE EVALUATION

### TAPE & REEL

DEVICE Name	Test Group	Year Packed	Storage	Pkg Group	Pkg	Pin
LMV331IDBVR	1	2006	Reel in cardboard box	SOT23	DBV	5
SN103770LPR	2	1991	Reel in black conductive bag	TO92	LP	3
PTSC2101IRGZR-1	3	2004	Reel in cardboard box	VQFN	RGZ	48
GD75232DWR	4	2004	Reel in moisture barrier bag	SOIC	DW	20
74AC11175DWR	5	1999	Reel in cardboard box	SOIC	DW	20
TSC2101IRGZR	6	2005	Reel in moisture barrier bag	SOIC	RGZ	48
74ACT11374DWR	7	2000	Reel in cardboard box	SOIC	DW	24
TPS2201IDFR	8	2001	Reel in cardboard box	SSOP	DF	30
CDC341DW	9	2000	Reel in cardboard box	SOIC	DW	20
PCM1803DB	10	1999	Reel in cardboard box	SSOP	DB	20
SN101013N	11	1998	Reel in cardboard box	PDIP	N	16
SN74AVC1G14DBVR	12	2002	Reel in Sealed Static shield bag	SOT23	DBV	5
SN74AHC1GU04DBVR	13	2003	Reel in Sealed Static shield bag	SOT23	DBV	5

### TUBES

DEVICE Name	Test Group	Year Packed	Storage	Pkg Group	Pkg	Pin
DRV135UA	A	2001	Black Tube in Sealed Moisture Barrier Bag	SOIC	D	8
ADS7846N	B	2002	Black Tube in Sealed Moisture Barrier Bag	TSSOP	PW	16
PGA205BP	C	2004	Black Tube in Sealed Moisture Barrier Bag	PDIP	N	16
INA118U	D	2001	Black Tube in Sealed Moisture Barrier Bag	SOIC	D	8
INA155U	E	2001	Black Tube in Sealed Moisture Barrier Bag	SOIC	D	8
DAC7612U	F	2002	Black Tube in Sealed Moisture Barrier Bag	SOIC	D	8
REG117A	G	2001	Antistatic Tube in opened moisture barrier bag	SOT223	DCY	4

## PACKAGE SPECIFIC TESTING

### LEAD SURFACE EXAMINATION AND INTERNAL VISUAL

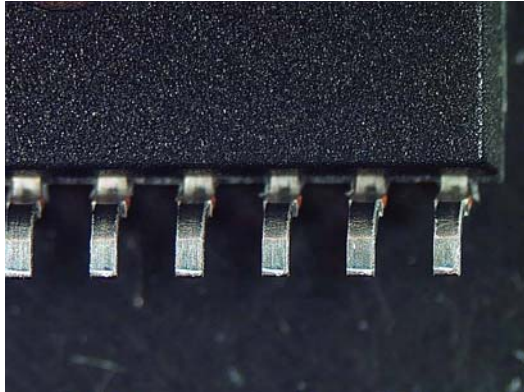

Figure 1 - Optical Micrograph of 74AC11175DWR device showing representative lead appearance

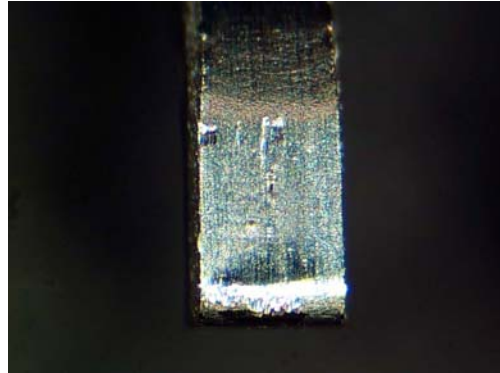

Figure 2 - Optical Micrograph of 74AC11175DWR representative device lead

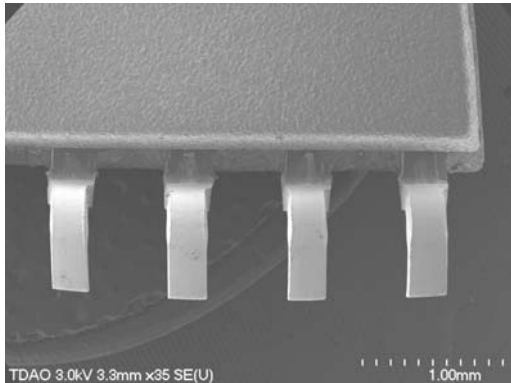

Figure 3 - FESEM Micrograph of 74AC11175DWR representative device leads - Bottom side of package

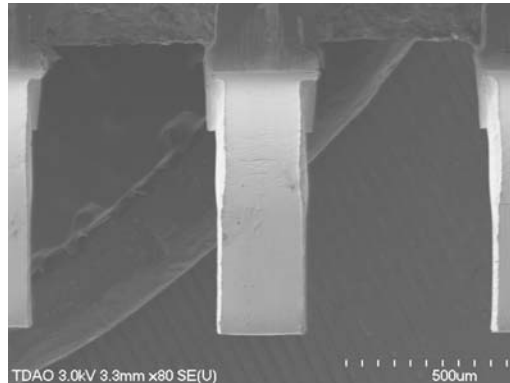

Figure 4 - FESEM Micrograph of 74AC11175DWR representative of device lead - Bottom of package

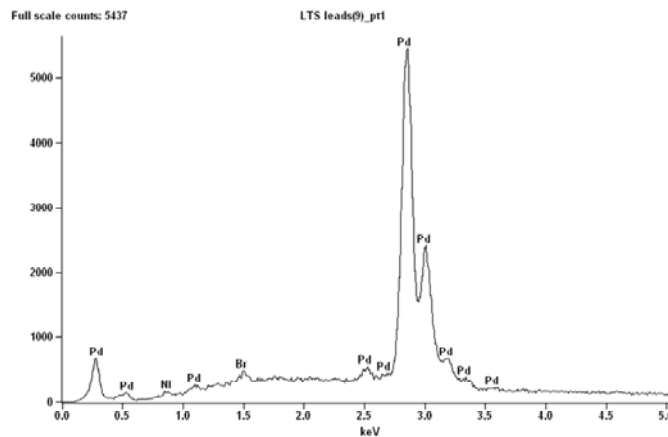

Figure 5 - Representative EDS spectrum of 74AC11175DWR lead surface showing typical elements present.



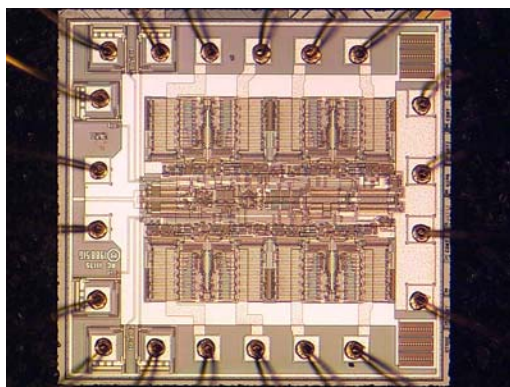

Figure 6 - Optical Micrograph of 74AC11175DWR representative die overview showing no abnormalities.

## SOLDERABILITY TEST

No indication of solderability degradation was observed in LTS or laboratory aged samples.

[Shelf-Life Evaluation of Lead-Free Component Finishes](#)<sup>1</sup>  
[TID – Old Datecode Study – 2007 \(Evaluation Work DW Package\)](#)<sup>2</sup>

## MSL VERIFICATION TEST

LTS devices were evaluated with standard JEDEC MSL verification tests. Obviously, time zero data was not available for the retained samples; however, comparisons with MSL CSAM data for current devices in similar packages revealed comparable performance. No evidence of package cracks or other anomalies were observed in the test samples.



Figure 7 CSAM image of TPS2201 prior to moisture/reflow simulation. No significant delamination observed.

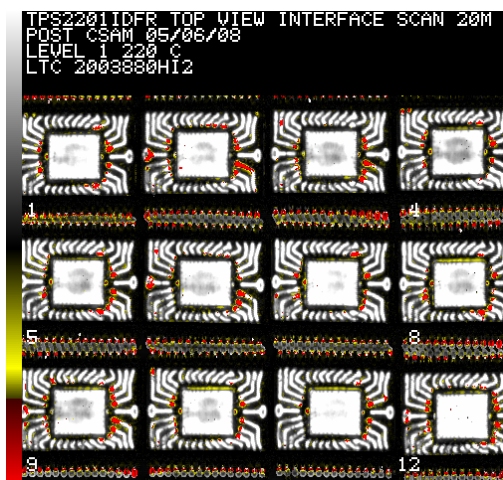

Figure 8 CSAM image of TPS2201 post Moisture/reflow simulation. Minor leadframe delamination observed.

## EXAMINATION AND PHOTOGRAPHS OF PACKING MATERIALS

Devices were shipped directly to the evaluation lab with the existing packing materials and labels intact. The metallized heat sealed bags were opened and the contents photographed. Humidity Indicator Cards (HIC) were examined.



Figure 9 DAC7612U devices in a moisture barrier bag.



Figure 10 74ACT11374DWR devices in original sealed pizza box.



Figure 11 TSC2101IRGZR devices in original sealed pizza box.



Figure 12 GD75232DWR devices in original sealed moisture barrier bag.



Figure 13 TSC2101IRGZR devices in original sealed moisture barrier bag.



Figure 14 TSC2101IRGZR devices in original tape and reel with 1 desiccant and moisture indicator labels.

## TRIBOCHARGE EVALUATION TOOL



Figure 15 ESD Analyzer with Faraday cup and voltage field meter.



## PBFT – PEEL BACK FORCE TOOL



Figure 16 Peel-Back Force Test (PBFT) System.

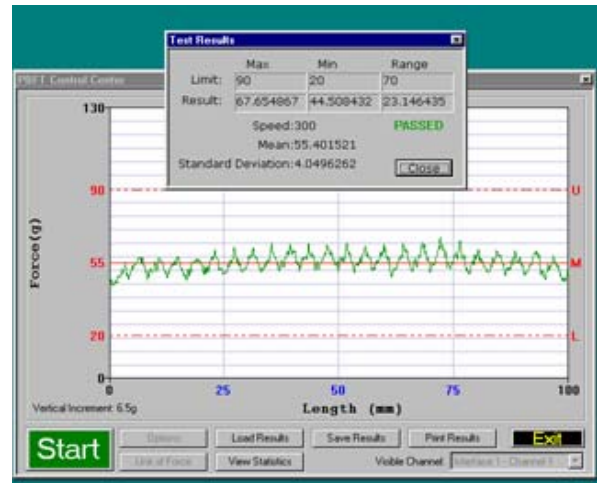

Figure 17 PBFT screen shot.



Figure 18 Less than 20 volts detected during measurement of the static charge generated during peel back testing.

## SUMMARY OF RESULTS

- No failure mechanisms have been identified that would compromise the reliability of plastic encapsulated ICs with NiPdAu lead finish stored for extended periods of time in a warehouse environment.
- Tribocharge voltages on LTS tape and reel samples during cover tape removal were comparable to current tape and reel samples.
- Tribocharge data from clear antistat tubes and black conductive tubes were compared to fresh tubes from stock. Charges measured on devices removed from the aged tubes were comparable to new tubes.
- Surface analysis of LTS leads revealed expected elements. SEM and optical microscopy revealed nothing abnormal. No degradation of the lead finish was observed.
- HIC color change with humidity was observed with all cards from the current qualified vendor.
- Solderability of LTS leads met all expectations and was indistinguishable from current devices.
- No degradation of MSL performance was observed.

## CONCLUSION

The shelf life of LTS devices as determined by solderability, SEM visual, SEM spectral analysis, optical microscopy, MSL performance, solderability, and decapsulation/visual is >15 years.

IC packing material shelf life is limited by moisture diffusion through the MBB. A standard MBB maintains satisfactory moisture levels for 32 months. LTS bags control moisture levels beyond 5 years.

## ACKNOWLEDGMENTS

The author wishes to recognize the following individuals for their professional assistance:

Alison Brown of TI Dallas for Technical Assistance

Bill Brumley of TI Tucson for Technical Assistance

Lucas Copeland of TI Tucson for Optical and SEM Analysis

Albert Escusa of TI Dallas for Technical Assistance

Rin Key of TI Dallas for Technical Assistance

Sreenivasan Koduri of TI Dallas for Technical Assistance

Bernhard Lange of TI Germany, Lead Engineer for Solderability Testing, Wetting Balance, and Surface Resistivity Analysis in the 2004 Long Term Storage Study

Dave McKeehan of TI Oslo, Project Manager for the 2004 Long Term Storage Study

Fred Miranda of TI Tucson for Tribocharge Evaluations, PBFT Testing, and MSL Characterization in the current study.

Julie Terlisner of TI Tucson for Report Formatting and Editing

Todd Wyant of TI Dallas for Long Term Storage Bag Evaluation

Mark Yampolsky of TI Tucson for Technical Assistance

## GLOSSARY OF TERMS

**Desiccant:** A hygroscopic substance used to remove moisture from moisture barrier bags.

**Humidity Indicator Card:** (HIC) – A card printed with a moisture sensitive chemical (cobalt chloride) that changes from blue to pink in the presence of water vapor.

**Long Term Storage:** (LTS) – Storage of devices in an uncontrolled indoor environment for more than two years.

**Moisture Barrier Bag:** (MBB) – Storage bag manufactured with a flexible laminated vapor barrier film that restricts transmission of water vapor.

**Nickel, Palladium, Gold:** (NiPdAu) – Metal layers that are pre-plated on leadframes to enable solderability.

**Shelf Life:** The time that moisture sensitive devices may be stored in MBB with desiccant and HIC or MSL 1 devices stored at room ambient.

**Water Vapor Transmission Rate:** (WVTR) – A measure of permeability of MBBs to water vapor.

---

<sup>1</sup> [Douglas W. Romm, Donald C. Abbott, Bernhard Lange “Shelf-Life Evaluation of Lead-Free Component Finishes” \(June 2004\)](#)

<sup>2</sup> [Andreas Huber, Bernhard Lange “TID Old Datecode Study 2007” \(October 12, 2004\)](#)

<sup>3</sup> [Lee Lewis, Eddie Moltz “Semiconductor Packing Evaluation for Extended Shelf Life” \(March 18, 2003\)](#)

<sup>4</sup> [NEDA Publication, “Managing Date Code Restrictions on Orders for Electronic Components” \(2002\)](#)

<sup>5</sup> [Howard Immel, Dan Hammack “Mocon Testing Service Job Number: 32678T” \(April 30, 2008\)](#)

## IMPORTANT NOTICE

Texas Instruments Incorporated and its subsidiaries (TI) reserve the right to make corrections, modifications, enhancements, improvements, and other changes to its products and services at any time and to discontinue any product or service without notice. Customers should obtain the latest relevant information before placing orders and should verify that such information is current and complete. All products are sold subject to TI's terms and conditions of sale supplied at the time of order acknowledgment.

TI warrants performance of its hardware products to the specifications applicable at the time of sale in accordance with TI's standard warranty. Testing and other quality control techniques are used to the extent TI deems necessary to support this warranty. Except where mandated by government requirements, testing of all parameters of each product is not necessarily performed.

TI assumes no liability for applications assistance or customer product design. Customers are responsible for their products and applications using TI components. To minimize the risks associated with customer products and applications, customers should provide adequate design and operating safeguards.

TI does not warrant or represent that any license, either express or implied, is granted under any TI patent right, copyright, mask work right, or other TI intellectual property right relating to any combination, machine, or process in which TI products or services are used. Information published by TI regarding third-party products or services does not constitute a license from TI to use such products or services or a warranty or endorsement thereof. Use of such information may require a license from a third party under the patents or other intellectual property of the third party, or a license from TI under the patents or other intellectual property of TI.

Reproduction of TI information in TI data books or data sheets is permissible only if reproduction is without alteration and is accompanied by all associated warranties, conditions, limitations, and notices. Reproduction of this information with alteration is an unfair and deceptive business practice. TI is not responsible or liable for such altered documentation. Information of third parties may be subject to additional restrictions.

Resale of TI products or services with statements different from or beyond the parameters stated by TI for that product or service voids all express and any implied warranties for the associated TI product or service and is an unfair and deceptive business practice. TI is not responsible or liable for any such statements.

TI products are not authorized for use in safety-critical applications (such as life support) where a failure of the TI product would reasonably be expected to cause severe personal injury or death, unless officers of the parties have executed an agreement specifically governing such use. Buyers represent that they have all necessary expertise in the safety and regulatory ramifications of their applications, and acknowledge and agree that they are solely responsible for all legal, regulatory and safety-related requirements concerning their products and any use of TI products in such safety-critical applications, notwithstanding any applications-related information or support that may be provided by TI. Further, Buyers must fully indemnify TI and its representatives against any damages arising out of the use of TI products in such safety-critical applications.

TI products are neither designed nor intended for use in military/aerospace applications or environments unless the TI products are specifically designated by TI as military-grade or "enhanced plastic." Only products designated by TI as military-grade meet military specifications. Buyers acknowledge and agree that any such use of TI products which TI has not designated as military-grade is solely at the Buyer's risk, and that they are solely responsible for compliance with all legal and regulatory requirements in connection with such use.

TI products are neither designed nor intended for use in automotive applications or environments unless the specific TI products are designated by TI as compliant with ISO/TS 16949 requirements. Buyers acknowledge and agree that, if they use any non-designated products in automotive applications, TI will not be responsible for any failure to meet such requirements.

Following are URLs where you can obtain information on other Texas Instruments products and application solutions:

### Products

Amplifiers	<a href="http://amplifier.ti.com">amplifier.ti.com</a>
Data Converters	<a href="http://dataconverter.ti.com">dataconverter.ti.com</a>
DSP	<a href="http://dsp.ti.com">dsp.ti.com</a>
Clocks and Timers	<a href="http://www.ti.com/clocks">www.ti.com/clocks</a>
Interface	<a href="http://interface.ti.com">interface.ti.com</a>
Logic	<a href="http://logic.ti.com">logic.ti.com</a>
Power Mgmt	<a href="http://power.ti.com">power.ti.com</a>
Microcontrollers	<a href="http://microcontroller.ti.com">microcontroller.ti.com</a>
RFID	<a href="http://www.ti-rfid.com">www.ti-rfid.com</a>
RF/IF and ZigBee® Solutions	<a href="http://www.ti.com/lprf">www.ti.com/lprf</a>

### Applications

Audio	<a href="http://www.ti.com/audio">www.ti.com/audio</a>
Automotive	<a href="http://www.ti.com/automotive">www.ti.com/automotive</a>
Broadband	<a href="http://www.ti.com/broadband">www.ti.com/broadband</a>
Digital Control	<a href="http://www.ti.com/digitalcontrol">www.ti.com/digitalcontrol</a>
Medical	<a href="http://www.ti.com/medical">www.ti.com/medical</a>
Military	<a href="http://www.ti.com/military">www.ti.com/military</a>
Optical Networking	<a href="http://www.ti.com/opticalnetwork">www.ti.com/opticalnetwork</a>
Security	<a href="http://www.ti.com/security">www.ti.com/security</a>
Telephony	<a href="http://www.ti.com/telephony">www.ti.com/telephony</a>
Video & Imaging	<a href="http://www.ti.com/video">www.ti.com/video</a>
Wireless	<a href="http://www.ti.com/wireless">www.ti.com/wireless</a>

Mailing Address: Texas Instruments, Post Office Box 655303, Dallas, Texas 75265  
Copyright © 2008, Texas Instruments Incorporated