

# Enclosed Media Printing as an Alternative to Metal Blades

**Michael L. Martel**  
Speedline Technologies Inc.  
Franklin, Massachusetts, USA  
mmartel@speedlinetech.com

## Abstract

Fine pitch/fine feature solder paste printing in PCB assembly has become increasingly difficult as board geometries have become ever more compact. The printing process itself, traditionally the source of 70% of all assembly defects, finds its process window narrowing. The technology of metal blade squeegees, with the aid of new materials, understanding, and settings such as blade angle, has kept pace with all but the smallest applications, e.g., 200 $\mu$  - .50 AR and 150 $\mu$  - .375 AR, which have been pushing blade printing technology to its limits.

Enclosed media print head technology has existed, and has been under increasing development, as an alternative to metal squeegee blade printing. Until recently, the performance of enclosed print heads had been comparable to the very best metal squeegees, but advances in enclosed print media technology have now made it a superior alternative to squeegee blades in virtually all applications.

## Introduction

Solder paste printing through stencils has long been achieved using metal blades, or 'metal squeegees', which replaced polymer squeegee blades due to performance issues years ago. The move from screens to stencils, and then to smaller apertures and fine pitch land patterns, necessitated the change to metal, which offered superior printing performance characteristics.

The evolution of PCBs, in terms of the miniaturization of assemblies, components, and ever-finer feature print patterns, has not slowed, and as a result continues to present ever-increasing challenges to the makers of assembly equipment and solder paste printing technology, narrowing the process window. Fine pitch and fine-feature printing applications, e.g., 200 $\mu$  - .50 Area Ratio (AR) and 150 $\mu$  - .375 AR, have been pushing blade printing technology to its limits.

Skilled printer operators using superior metal blade alloys, varying angle of attack, etc. can achieve acceptable results against the most challenging printing applications, but there are shortcomings that include considerable materials waste, which translates into significant cost, less fill volume as apertures become smaller, and unacceptable variation in the consistency of results. Newly-developed enclosed print media technologies have been developed as an alternative to metal blade printing. Due to recent advances, enclosed media printing delivers overall better results when measured against ordinary-use metal blades, and they excel in material savings since the print head encloses the solder paste or other media from the surrounding atmosphere, and provides steady and uniform results for fine feature aperture filling due to tight process control. For these and other reasons that will be outlined in this paper, they constitute an attractive alternative to metal blade printing.

## Aperture Fill is Key

When printing fine pitch or fine features especially, good aperture fill volume is the key to well-formed solder joints without insufficiencies. Aperture fill results from downward pressure on the paste by the squeegee, forcing solder paste into the apertures. Pressure is generated by compression of the bead of paste, from the squeegee blade's angle of attack as it moves across the stencil and rolls the bead of solder paste before it. Variations in the blade angle (some creatively) can, with some tweaking, optimize the print process. But there are always concerns relative to the uniformity of pressure across the blade, or the quantity of paste in a given spot, which can also be affected by high-volume requirements (through-hole, paste-in-hole) on the same stencil adjacent to fine pitch apertures. With squeegee blade printing, gauging the prospect of successful aperture fill has always been subject to the vagaries of area ratio. The more disproportionately greater the surface area of the stencil wall to the pad area, the better the chance that, when the stencil peels away, the paste will remain with the stencil.

With fine feature devices, the primary printing defect is poor or insufficient aperture fill. Without proper or complete fill, the solder paste may not adhere to the pad, and pull away/remain in the aperture; or it may result in a 'starved' solder joint (or incomplete joint) if undetected by the downstream SPI machine. Some of the causes of insufficient aperture fill are the same causes identified for other print defects, e.g., pause in printing/raised paste viscosity; squeegee speed too high or too low; squeegee pressure too low; not enough paste on stencil; and others.

Proper or optimum aperture fill for fine feature printing is not only a function of mechanical setup and squeegee blade material and parameters, but also a function of having a precisely-controlled volume of solder paste at all times on the stencil. Control is a keyword here; the more fine-featured the printing application, the greater the degree of precise control over the process that needs to be exercised. For example, “In a majority of operations, operators scoop solder paste onto the stencil without precisely measuring the amount applied. A few companies specify the amount of solder paste to be placed on the stencil at the beginning of a production run (i.e. one full 350 g jar), but most do not. Yet even these former companies fall short of full control of the volume of solder paste on the stencil when setting up the paste dispenser. Most paste dispense processes are suited to a larger volume of paste (75 - 150 g), and dispensed at infrequent intervals (every 40 - 50 prints). As a result, the roll size can still change significantly during the course of the shift...a 100g change in solder roll size will cause approximately a 7% change in maximum paste filling pressure. This is a significant change. It is enough to dramatically alter the solder paste print quality, especially on small apertures...A larger solder paste roll will have higher applied pressure, as well as a longer time that the pressure is applied. Too large a roll size for a given speed applies too much pressure to the aperture for a too long time, increasing the potential for bridging of fine pitch devices...True solder paste volume control can be accomplished in one of two ways: via an enclosed print head, or to dispense more accurately and more often.”<sup>1</sup>

The smaller the pad/aperture, the more dramatic the effects of poor aperture filling, due to the more precise (and smaller) volume of paste required to create a successful solder joint. The absence of a specific small volume of paste from a large pad print, with no deleterious effect on the solder joint ultimately formed, could, for a fine feature component, be the entire amount of paste required for that connection.

**Enclosed Media Print Head Technology**

Enclosed media print head technology was designed to provide the same required pressurization of the solder paste as the squeegee blade’s angle of attack, but uniformly across the length of the print head while printing, regardless of the amount of paste in the enclosed chamber. The key to consistency and uniformity in printing results, where the stencil or print application requirements were anything but uniform, was determined to be direct, fast-response control of paste pressure. This would have to be closed-loop controlled so that pressurization could respond to such demands, for example, as are made by through-hole fills that require a very high volume of paste, rather than a pattern of fine pitch pads. Additionally, with optimum aperture fill, the more likely the paste will cover the entire pad area, and that its tack will be sufficient to keep it on the pad when the stencil peels off.

Efforts to improve the printing performance of enclosed media resulted in a change in the way that the paste in the paste chamber is pressurized. Rather than indirectly or pneumatically, pressurization is accomplished mechanically by a motor-driven plunger or piston that is separated from the paste by a membrane. The plunger applies pressure directly to the volume of paste in the chamber, and a series of transducers sense the pressure and are part of a closed-loop system of very tight pressure control, which maintains chamber pressure actively at +/- 0.1 psi from set point.

In comparative printing tests against squeegee blades, these expectations proved correct, and surprisingly, the finer the feature, the better the results that were obtained with enclosed media. For example, whereas with metal squeegee blades, the finer the aperture, the less percentage of desired volume could be depended upon, with enclosed media, the trend was just the opposite, with print volumes over 50% for 150 Micron apertures with a 0.375 Area Ratio.

Table 1. Volume and Standard Deviation Comparison with Squeegee Blades

Device Type	Enclosed Print Head Volume	Enclosed Print Head Std. Deviation
0201	5% Greater	4% Less
BGA 80	9% Greater	18% Less
150µ - .375 AR	54% Greater	26% Less

**Table 1** shows the results of comparative tests between printing with an enclosed media print head and metal blade squeegees. Note that the finer the aperture, the more the quality and consistency of squeegee blade printing deteriorates compared to the performance of enclosed media.

### Print Head Design and Operation

The enclosed media print head maintains solder paste in a closed print chamber that can be pressurized to force the solder paste out of the chamber and onto the substrate. Conventional squeegee blades are replaced with metal blades that function as both scraper and seal. These blades are aligned in a leading edge configuration at 45 degrees, as opposed to a typical trailing edge squeegee configuration. The inwardly- inclined blades are 10mm apart at the point of contact with the stencil. When the head is lowered onto the stencil, the stencil foil will close the entire print chamber during operation and allow a positive pressure to be generated inside. Silicone dams seal the opposite ends of the chamber.

The pressure inside the chamber is generated by a plunger, or piston, that is motor-driven downwards into the upper part of the chamber to generate pressure. A flexible membrane separates the plunger from the solder paste. Three (3) pressure transducers measure the internal chamber pressure and feed this information back to a control system that drives the plunger to the required height to actively maintain the desired pressure to +/- 0.1 psi from set point. With every print cycle, more solder paste transfers out of the head onto the substrate while the plunger travels further down into the chamber.

A low-level sensor detects when the plunger reaches the lowest position, thus triggering the refilling of the head with solder paste. The paste is provided from two industry-standard cartridges that are mounted onto the front of the head. Air pressure is applied to the cartridges to force the paste out of the cartridges and into the chamber. The plunger is kept at its upper position during this fill routine. Once the pressure transducers read a defined fill pressure inside the chamber, the air pressure to the cartridges is relaxed and the plunger moves back down onto the membrane. The enclosed media print head is ready to continue printing.

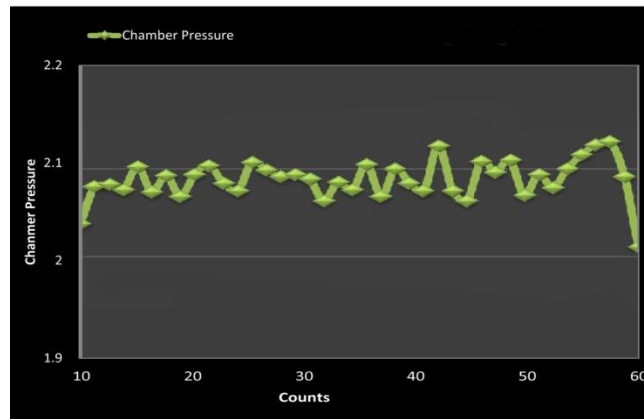

**Figure 1. Chamber Pressure Consistency Plot**

**Figure 1** is a plot of chamber pressure during a simulated production run. Inter-board pressure data illustrates how tight, closed-loop chamber pressure control is maintained consistently board to board regardless of paste consumption requirements (large apertures & small).

### Operation

Prior to the first print, the head chamber must be filled completely with solder paste. The filling operation is supported by a dedicated software routine that ensures that the machine is in the correct status for this operation. During the fill routine, the plunger is positioned at a fixed 'fill position' above the membrane, for the purpose of limiting the expansion of the membrane upwards while solder paste is being forced out of the cartridges and into the chamber. At the end of the fill routine, the plunger is moved to the relaxed distance relative to the fill position.

The enclosed media print head differs from similar types of print heads in that pressure is applied to the solder paste mechanically, not through air (pneumatic) pressure. The print head consists primarily of a paste chamber that is filled with solder paste from standard industry paste cartridges. These replaceable cartridges are mounted onto the print head assembly. Air pressure is used (software-controlled) to drive the paste out of the cartridges, through a manifold, and into the paste chamber. Pneumatic pressure is employed only to fill the chamber; it plays no role in pressurizing the paste for printing. Print pressure is supplied through a plunger (piston).

Three (3) robust, highly sensitive pressure transducers ensure tight control of pressure inside the head during filling, as well as during printing. These sensors are mounted directly inside the paste chamber, and constantly monitor the chamber to ensure a constant 'full' status. The chamber is considered full when the fill pressure is averaged across the selected transducers. During printing, the head is designed to keep the chamber full, and is thus programmed to initiate an "In Production Fill" between cycles. A sensor reliably senses a paste empty condition in the cartridges. Blade assemblies on either end (front and rear) of the print head control the paste distribution and excess removal from the stencil. Blade assemblies consist simply of specially-designed blades attached to a round shaft.

**Materials Savings**

Customer data indicates that the materials and solder paste savings achievable with enclosed media can be in excess of 50%. Solder paste is saved because it does not dry out, does not need to be discarded at the end of a shift, and there is overall less throwaway and loss through cleaning. Every scenario will be different, but the one represented in Figure 2 (actual example) realized a payback in a little more than 28 weeks. Clearly, higher volumes of production, coupled with a higher cost solder paste, could easily shorten that time. Nonetheless, ROI for the enclosed media print head is relatively quick, across the board, based on material savings alone.

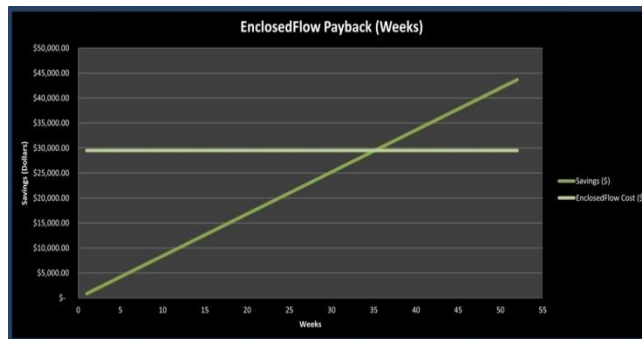

**Figure 2. Enclosed media payback in weeks**

<b>Savings per day - Board Scrap</b>	<b>\$ 50.00</b>
<b>Savings per day - Paste Useage</b>	<b>\$ 70.00</b>
<b>Pump Cleaning Paste Cost per day (Average)</b>	<b>\$ 2.92</b>
<b>Paste Disposal Savings per day</b>	<b>\$ 30.00</b>
<b>Payback (Weeks)</b>	<b>28.65</b>

**Figure 2a. Enclosed media payback detail**

**Conclusion**

Enclosed media printing technology is a suitable replacement for metal squeegee blades particularly for demanding fine pitch applications and mixed low and high volume paste consumption applications. The ability of enclosed media printing to successfully meet the volume fill requirements of ever-shrinking aperture sizes and lopsided aspect ratios is sufficient justification. Additionally, the paste savings over squeegee blade printing are significant, so much so that in the current economic climate, these cumulative savings can contribute to a relatively quick payback on the equipment investment, and have a measurable effect on the 'bottom line'.

**References**

[1] "Minimizing Solder Paste Printing Variation," George Babka, Assembléon America Inc., Circuits Assembly Magazine, Nov 2009, Vol. 20 Issue 11.

[2]“Effect Of Squeegee Blade On Solder Paste Print Quality”, Rita Mohanty, Bill Claiborne, Speedline Technologies, Franklin, Massachusetts; and Frank Andres, Cookson Electronics, South Plainfield, NJ; June 2010

[3]“Troubleshooting the Stencil Printing Process”, Chrys Shea, Shea Engineering Services, SMTA Houston Chapter, slide presentation, [http://www.smta.org/chapters/files/Houston\\_Troubleshooting\\_The\\_Stencil\\_Printing\\_Process\\_-\\_Chrys\\_Shea.pdf](http://www.smta.org/chapters/files/Houston_Troubleshooting_The_Stencil_Printing_Process_-_Chrys_Shea.pdf)

# **Enclosed Media Printing**

***AN ALTERNATIVE TO METAL BLADES***

**Michael L. Martel**

**Speedline Technologies Inc.**

**[mmartel@speedlinetech.com](mailto:mmartel@speedlinetech.com)**

# Outline

- **Introduction to Enclosed Media**
- **Benefits to the Process**
- **Configuration and How it Works**
- **Impact on the Printing Process**
- **Comparison to Blade Printing**
- **Evaluation Results**
- **Q & A**

## What is Enclosed Media?

- **Print media enclosed in a chamber**
- ***Mechanically* pressurized**
- **Closed loop pressure control**
- **Uniform pressure across print width**
- **Standard cartridge fill (pneumatic)**
- **Automated print head system**





# Materials & Applications

- Solder Paste Printing
- Flux printing for flip chip
- SMT Adhesives
- Adhesive Printing with thick stencils for boards with top side clenched leads - up to 0.060"
- Paste-in-Hole

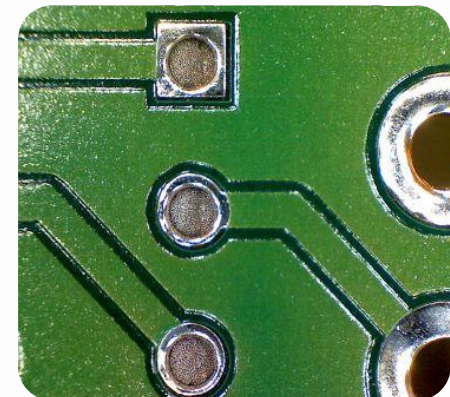
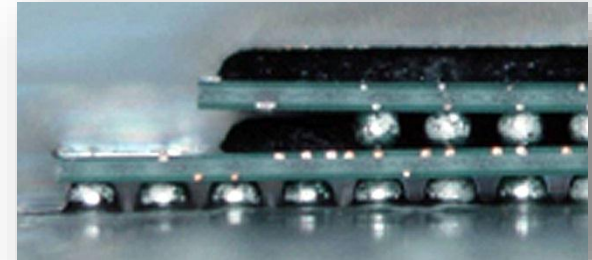

## Process Benefits

- Fine pitch and paste-in-hole printing solution
- Better aperture fill than squeegee blades
- Major materials savings: > 50%
- Easy to set up and use
- Less operator intervention
- Higher yields
- Lower standard deviation
- Reduced Cycle Times

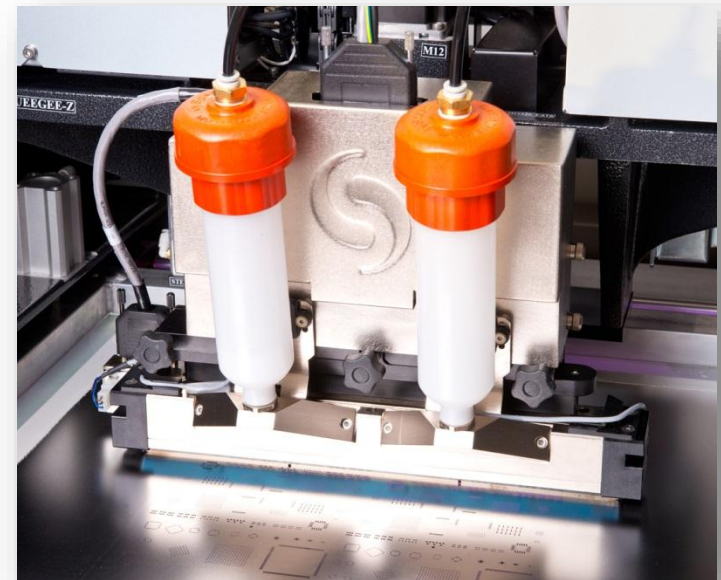

## Compared to Blade Printing

- **Better aperture filling**
- **Less variation**
- **Significant paste savings**
- **Consistent results from fine pitch to paste-in-hole**
- **Paste isn't exposed to the environment to dry out**
- **'Plug and Print' removal, storage, replacement**
- **Instant recovery after pauses**

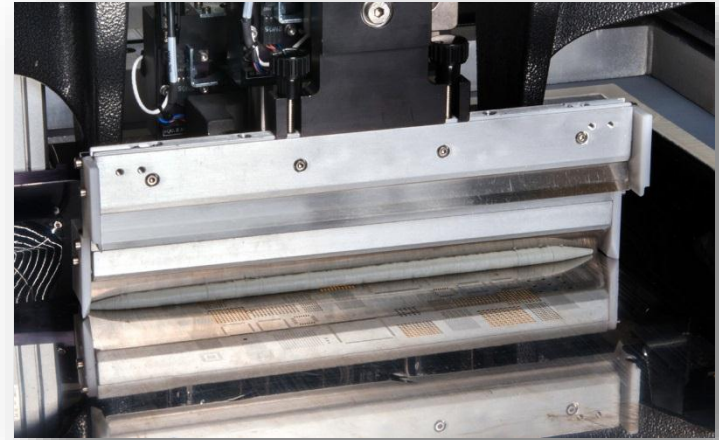

# Test Results vs. Squeegee Blades

*Higher paste volumes for challenging devices*

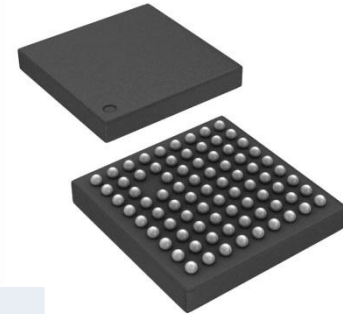

Device Type	Enclosed Media Volume	Enclosed Media Std. Deviation
0201	5% Greater	4% Less
BGA 80	9% Greater	18% Less
150μ - .35 Area Ratio	<b>54% Greater</b>	26% Less

Significantly greater volume with finer featured devices

Less standard deviation than blades as apertures grow smaller

# Print Consistency

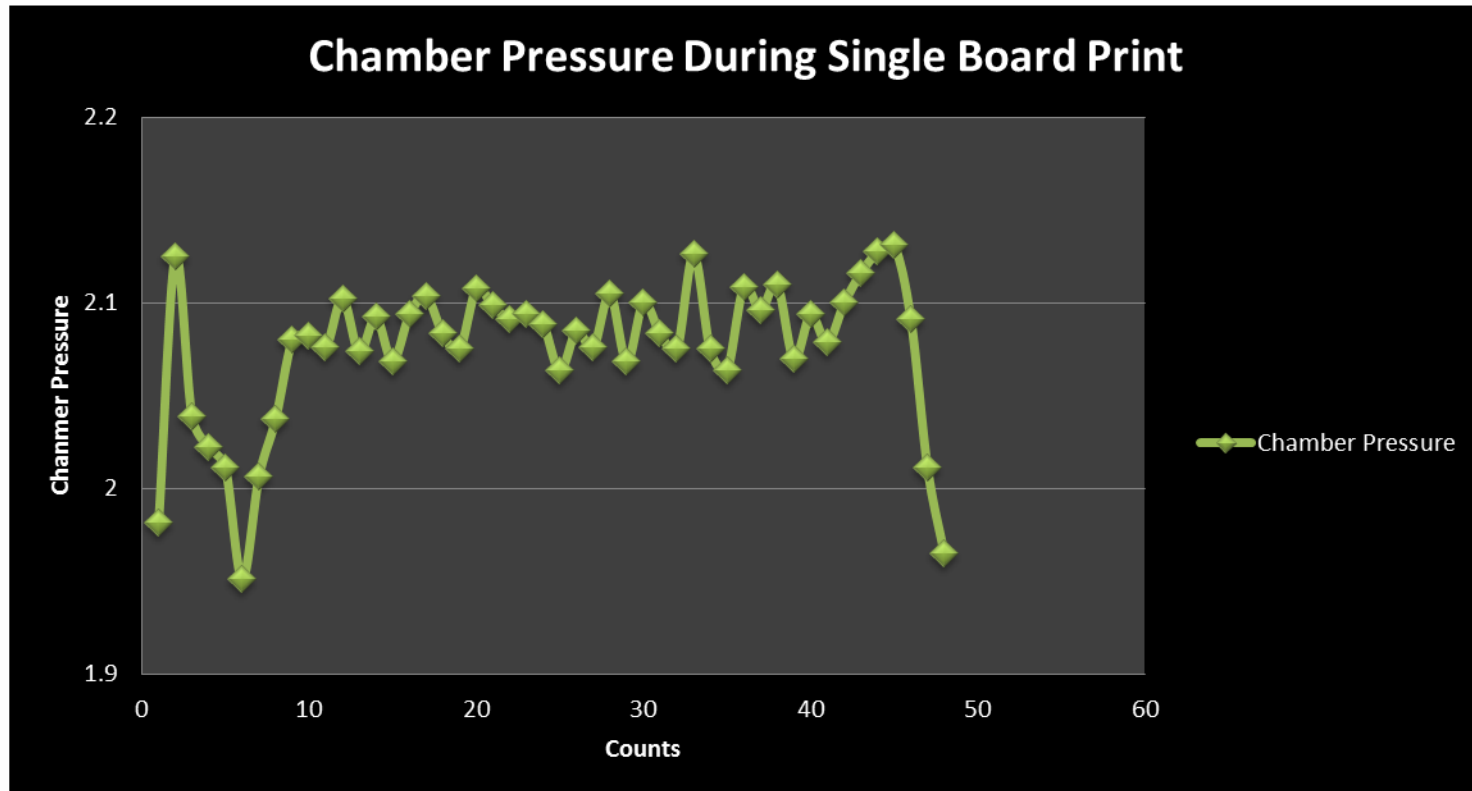

*Inter-board pressure data illustrates how tight, closed-loop chamber pressure control ensures print consistency board to board regardless of paste consumption requirements (large apertures & small)*

## Operation Sequence

- A motor-driven plunger precisely applies pressure via a flexible membrane directly to the print media during the print stroke. Pressure is closed-loop monitored and controlled
- Air pressure, applied to the cartridges, re-fills the paste chamber after the current print stroke. Pressure-sensing transducers sense when the chamber is full
- Ready for the next print stroke

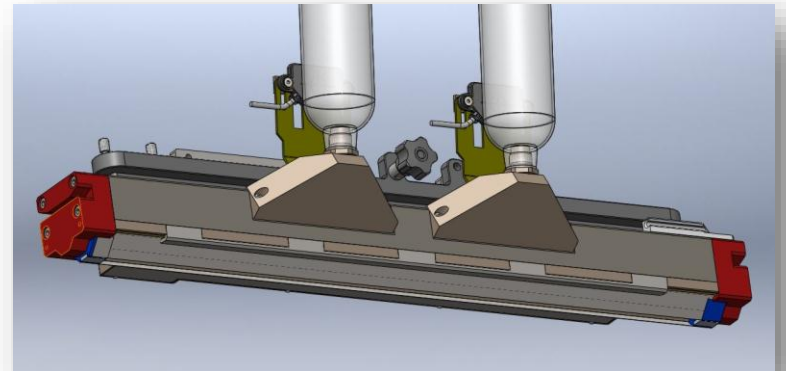

- At the end of the print stroke the print head remains in contact with the stencil foil.
- The paste plunger (bar) is raised only very slightly to relieve pressure in the chamber. The print head remains against the stencil creating a seal, and preventing paste from leaking out.



# Print Head Configuration

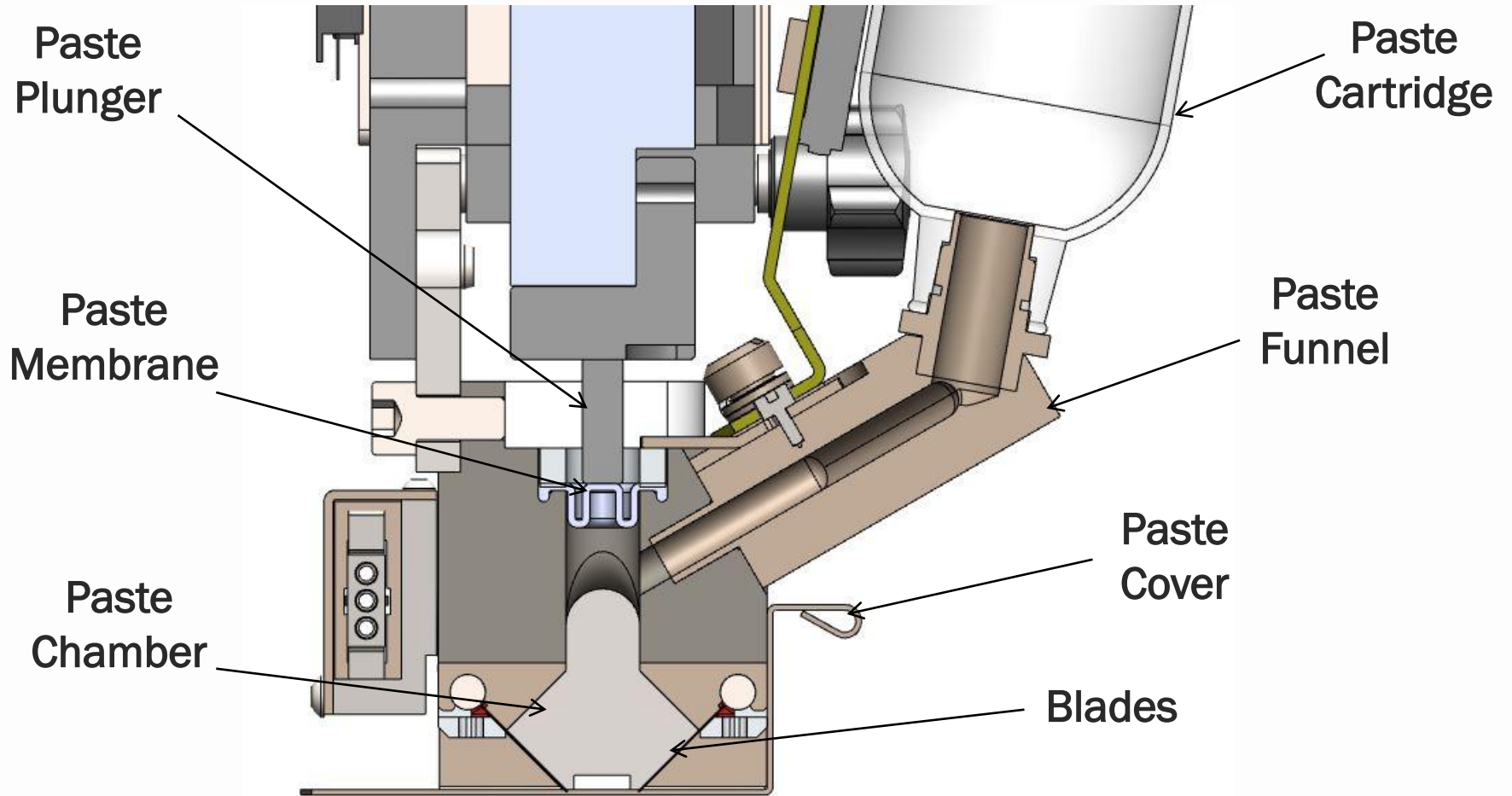



## Print Head Configuration (2)

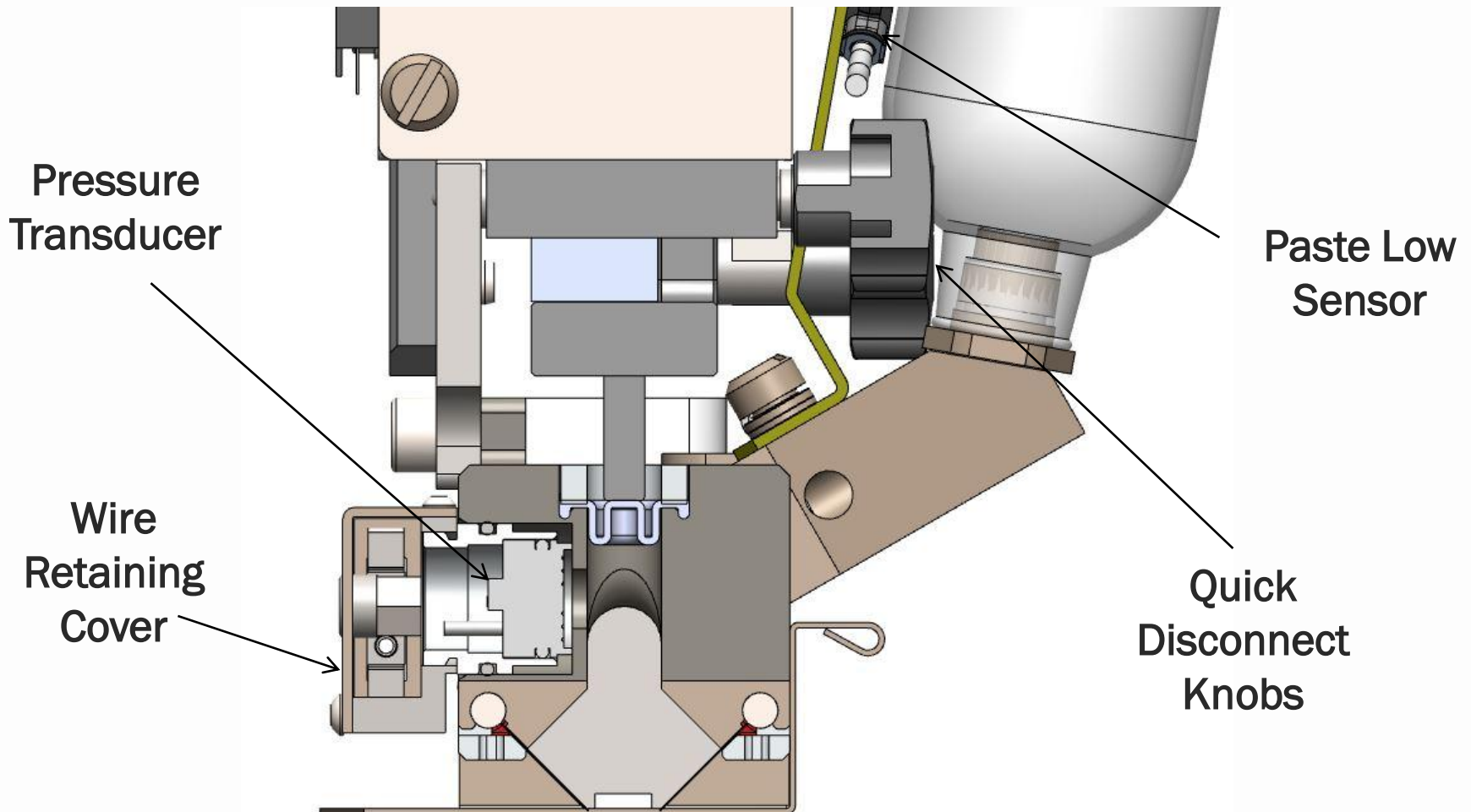

## Paste Management

- No constant pressure on solder paste in the system
- Industry standard cartridges
- Change in < 10 minutes
- Fully enclosed –  
no paste exposed to  
the atmosphere

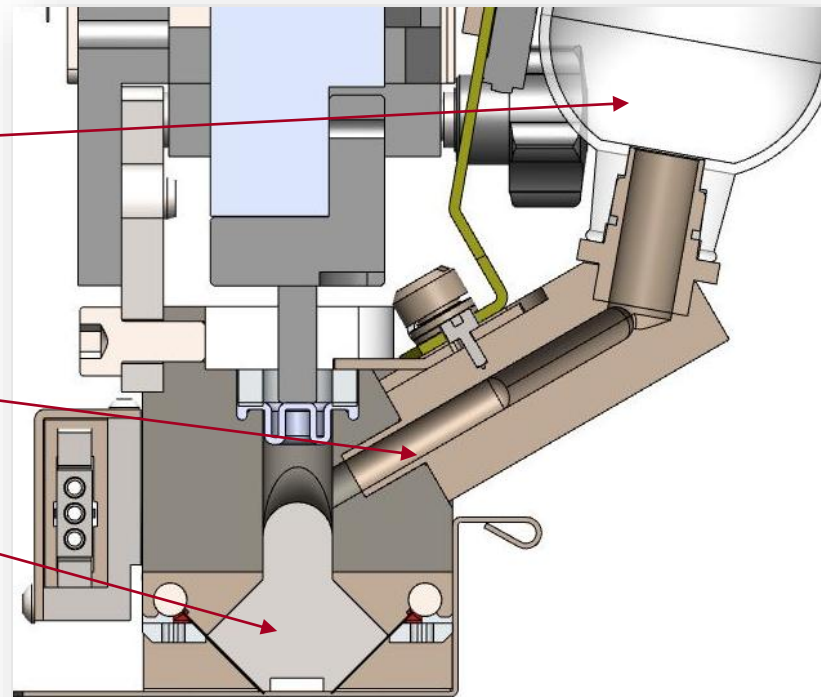

## Fine Feature Printing

- Motor-driven pressurized paste with closed-loop control ensures optimum aperture fill volumes
- Repeatable performance with less deviation than blade printing
- Print volumes over 50% for 150 $\mu$ m apertures with a 0.375 Area Ratio
- Breaking the '0.6 aspect ratio rule'

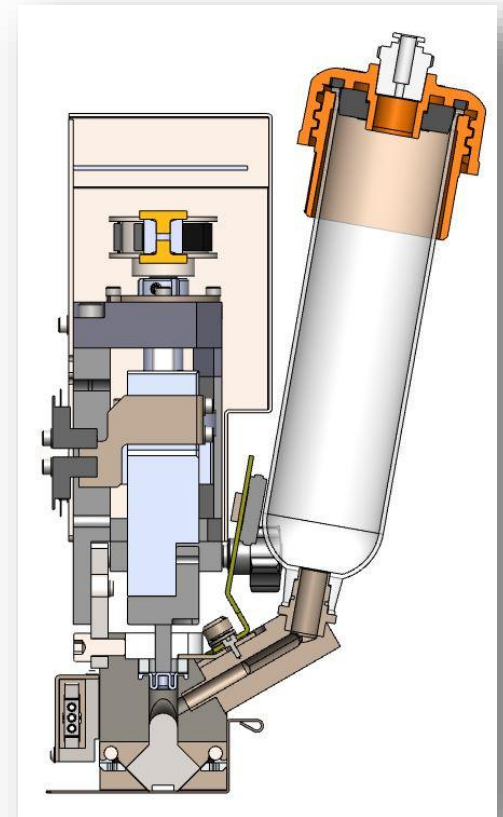

# Fine Feature Print Comparison

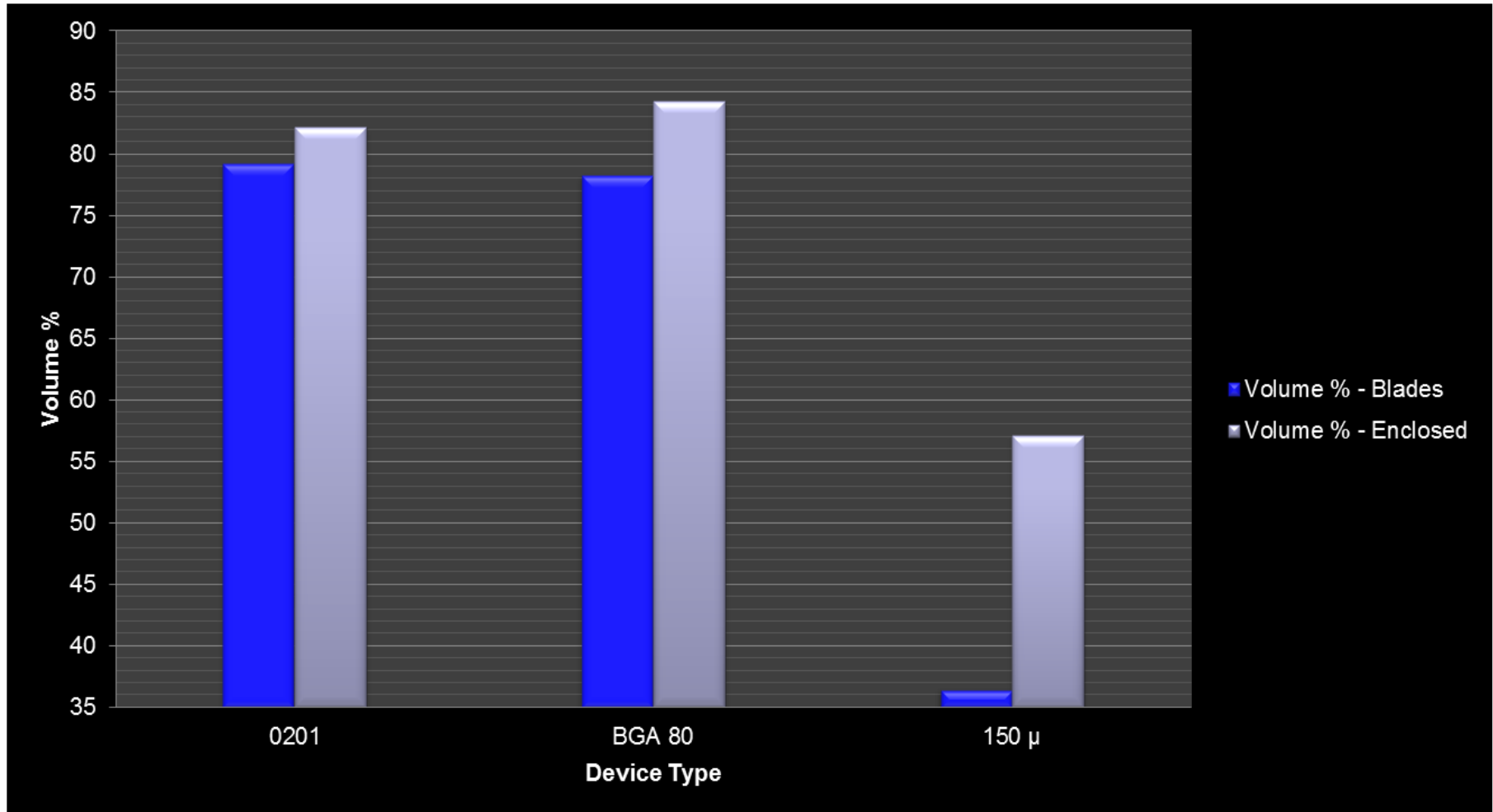

## Media Savings

- Reduce print media consumption by more than 50% over squeegee blades
- Paste held in fully enclosed chamber
- Avoid paste waste on sides of squeegee print area
- Less toxic metal reprocessing
- Less stencil cleaning



## Media Savings *(Cont'd)*

- Prevent defects caused by operators scraping dried paste back into the working paste bead
- Fully contained - avoid throwing away 100's of grams of material at the end of each shift
- At the end of the shift, install the pump cover and start up again the next day, or days later



### Enclosed Media Print System Payback (Weeks)

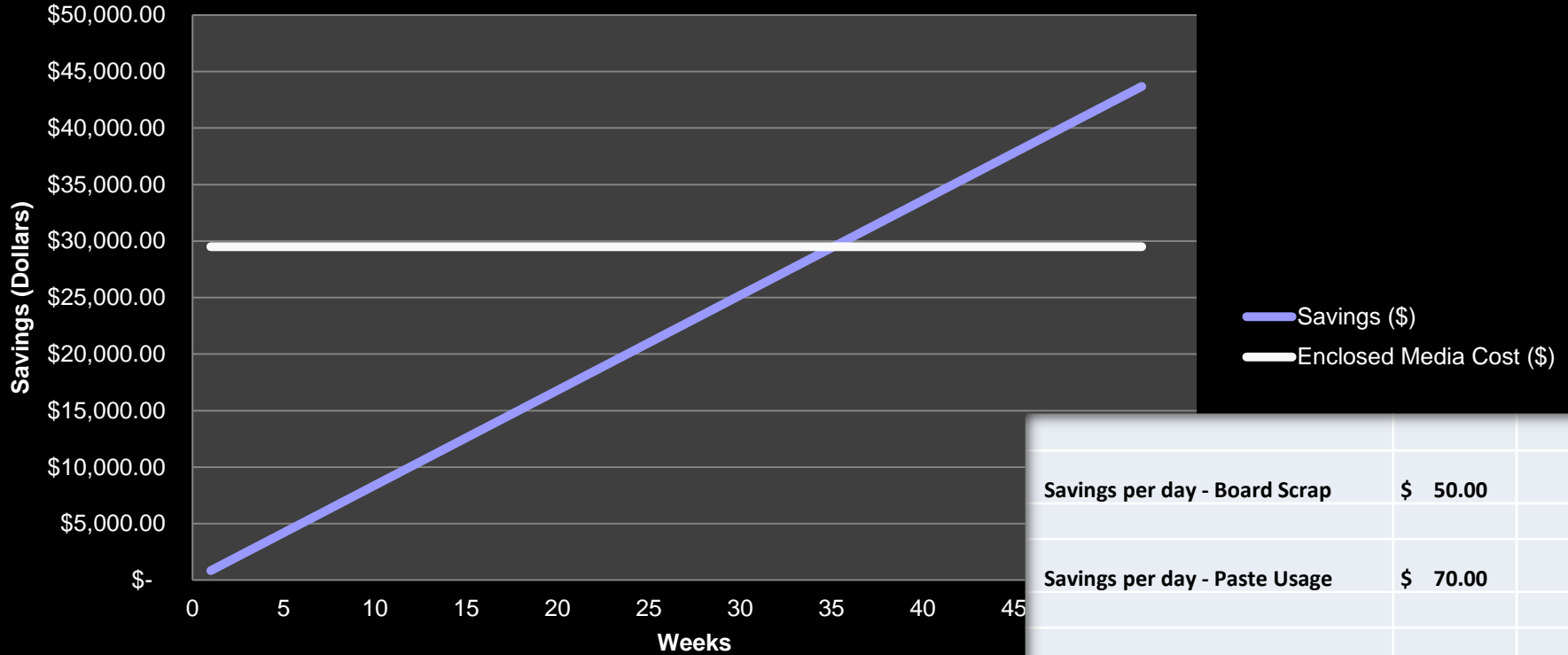

**Payback (Weeks) 28.65**

Savings per day - Board Scrap	\$ 50.00	
Savings per day - Paste Usage	\$ 70.00	
Pump Cleaning Paste Cost per day (Average)	\$ 2.92	
Paste Disposal Savings per day	\$ 30.00	
<b>Payback (Weeks)</b>	<b>28.65</b>	

## Case History # 1:

- Automotive Electronics
- 99.28% Yield over 19,119 PCBs
- Cleaning time reduced by 15-20 min
- Throughput up 14% (58,233 boards vs. 50,995 boards)
- Defect rate down by 51% over same period
- \$187k paste savings due to improved paste tube emptying

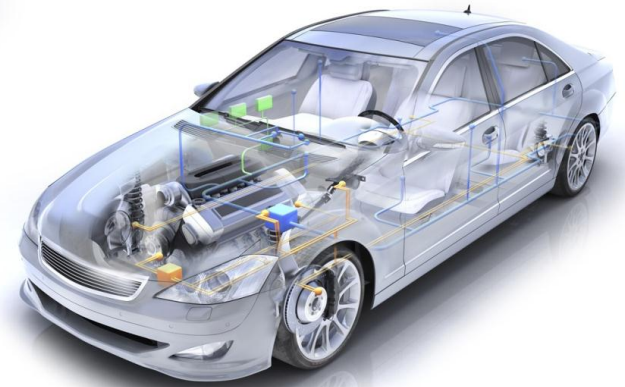



## Case History # 2:

- Consumer Electronics
- High density fine pitch
- Customer new to enclosed media
- Defect rate reduced to 1845ppm
- Customer no longer requires paste disposal at end of shift (up to 300g per line per day)



## Summary

- Better volume, less deviation than blades
- Highest comparable process control
- Instant recovery after pauses
- Easier to set up and use
- Major paste savings

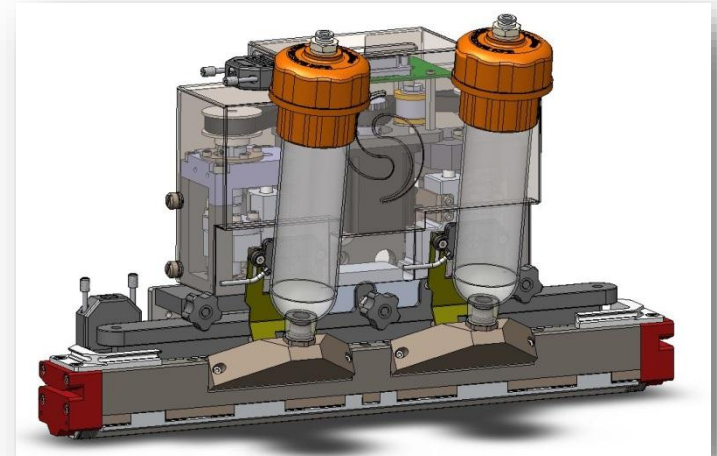



NEW IDEAS ... FOR NEW HORIZONS

MARCH 25-27, 2014

MANDALAY BAY RESORT AND  
CONVENTION CENTER

LAS VEGAS, NEVADA

***Thank You!***