

Corrosion Resistance of Different PCB Surface Finishes in Harsh Environments

Mustafa Özkök , Atotech Deutschland GmbH
Joe McGurran, Atotech USA Inc.
Hugh Roberts, Atotech USA Inc
Kenneth Lee, Atotech China
Guenter Heinz, Atotech Deutschland GmbH

ABSTRACT

Corrosion resistance is becoming one of the most important topics in the electronics industry. Corrosion results in field failures and huge losses, which annually total several billion U.S. dollars. The actual extent of losses caused by corrosion is not well documented in the industry. As such, corrosion is currently one of the most challenging topics and is acquiring more attention as a result of increased product warranties, new materials and process changes caused by recent legislation impacting the electronics industry.

Another factor is that the industry used in the past the lead containing surface finish “Hot Air Solder Leveling” (HASL) in very large volumes. This surface finish does have a superior corrosion resistance because of the Copper/Tin IMC and the corrosion resistance of the tin surface itself. Therefore corrosion resistance was for a long time no topic for the applications using HASL. But since the RoHS legislation came in effect in July 2006 and the use of lead containing HASL was restricted, the industry has looked into and qualified new alternative lead-free surface finishes. Furthermore the lead-free version of HASL shows some major disadvantages like uneven deposition thickness and as a higher working temperature is needed, a detrimental impact on the base material cannot be avoided. Companies do expect from these new alternative surface finishes to show the same corrosion resistance like HASL but many missed to investigate these alternatives concerning their corrosion resistance performance in combination with their applications. It only came to the attention of the electronics Industry as they were recently confronted with more and more field failures due to corrosion.

Depending on the final application and the environment to which the product is exposed, the requirements for corrosion resistance can be significantly different. Products used in military, automotive and medical applications typically demand higher corrosion resistance than products for lower performance or lifetime expectations, such as consumer electronics or similar products used in non-aggressive environments. As a result, to avoid corrosion on electronic products each industry sector has essentially adopted its own reliability testing procedures and standards. These facts all lead to the question, “What is the right corrosion resistance level of the surface finish for a particular product?”

One key function of surface finishes on printed wiring boards (PWB) is the protection of the underlying metal surface from environmental influences until assembly operations, such as soldering or wire-bonding, are performed. Also, after assembly there are areas on the PWB that are not covered by solder, including contact pads, test pads, heat seal and heat sink areas and the inside of through holes and vias. These areas are covered only by the surface finish and must still be resistant against any corrosive environment in the field. When corrosion occurs on a surface finish the metal decays and undefined corrosion products are created. The result of this process could be either an “open”, caused by attack of the underlying copper or a “short”, caused by creep from undefined corrosion products.

This paper investigates the performance of seven primary types of surface finishes using four different corrosion tests. The compiled data, findings and recommendations are offered as a guide to selecting the most suitable surface finish based on the end use application and required level of corrosion resistance.

INTRODUCTION

In particular, for the automotive and handheld electronic device industries the PWB requirements concerning reliability and lifetime are steadily growing. In addition, the highly competitive automotive industry offers extended warranties for cars (now three to five years), making the reliability of an electronic device a decisive product and cost advantage. Corrosion damages to the PWB surface are often the main reasons for a reduced reliability and product lifetime.

One function of the surface finish on PWBs is to withstand corrosive impacts until assembly operations are completed. However, areas not covered by solder after assembly, such as heat sinks and the inside of through holes and vias, must be protected in the field against harsh corrosive conditions. Therefore, it is imperative to choose the appropriate surface finish based on all final influences and specific product requirements for the end-use environment.

This paper discusses the corrosion resistance of seven common surface finishes. In the course of the investigations the performance of the surface finishes was determined via four standard industry corrosion tests. The results are finally presented as a guide, which should help in the selection of the most suitable surface finish based on the end-use requirements.

BACKGROUND

In general, corrosion is an interaction process between a material, adjacent materials and the environment. From a physiochemical point of view corrosion is the reaction of a system, which leads to a change of the material properties. It can cause defects by damaging the adjacent devices of the system, thus impairing the material function. In the final stage the corrosion can result in the total loss of the system functionality.

It is important to understand which conditions promote corrosion and what types of failure that corrosion products can generate. High humidity combined with a strong airflow and a saliferous environment can generate a harsh, corrosive atmosphere. Also, the presence of environmental gases (NO_2 , SO_2 , Cl_2) in conjunction with a certain level of humidity can have strong detrimental effects on the PWB surface finish. Many possibilities for corrosion-triggering errors exist within the PWB fabrication sequence, which can also be cumulative. For example, this path can begin with an unfavorable circuit design, followed by poorly controlled plating conditions and solder mask application. Improper storage and packing of the boards before assembly can further contribute to corrosion susceptibility. Storage is also critical following arrival of the PWBs at the assembly operation, when the boards are unpacked and cleanliness prior to soldering is decisive.

Another reason for corrosion is a significant difference in galvanic potential between precious metals and underlying base metals. A greater difference in electrochemical potential between two materials results in a stronger corrosive effect.

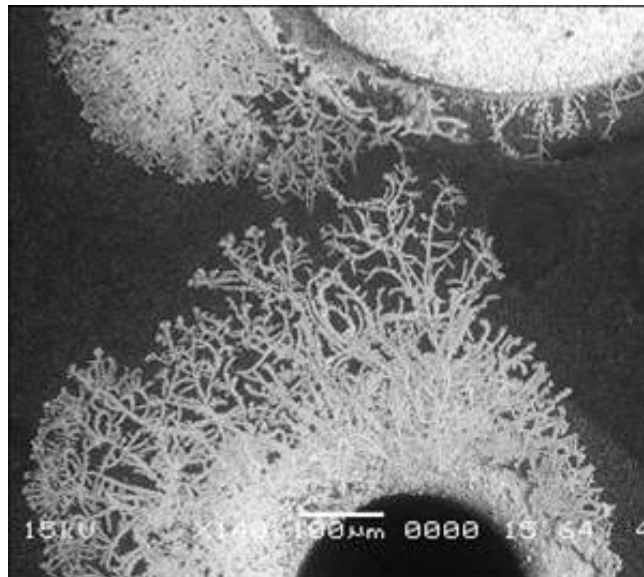

Fig. 1 Device with immersion silver surface finish. Cu_2S precipitates out of solution in a dendritic structure [2]

The corrosion products are various oxide compounds with different physical characteristics. These multi-colored oxide mixtures can cause a variety of electronic failures, ranging from interruptions to shorts. Also, such corrosion can cause damaged switch contact areas and contact losses in electronic devices.

Corrosion Mechanism

In general, the corrosion mechanism can be divided into two simple steps. In the first step, commonly known as tarnishing, oxygen from the air is adsorbed on the metal surface. Via a chemical oxidation reaction, a thin metal oxide layer is formed between the metal surface and the adsorbed oxygen. In the second step, known as scaling, the metal electrons and cations are typically migrating to the outer surface (rarely does oxygen diffuse inside the metal layer). Ultimately, different oxides form on the metal surface as its porosity increases and the functionality of the PWB is damaged or possibly destroyed.

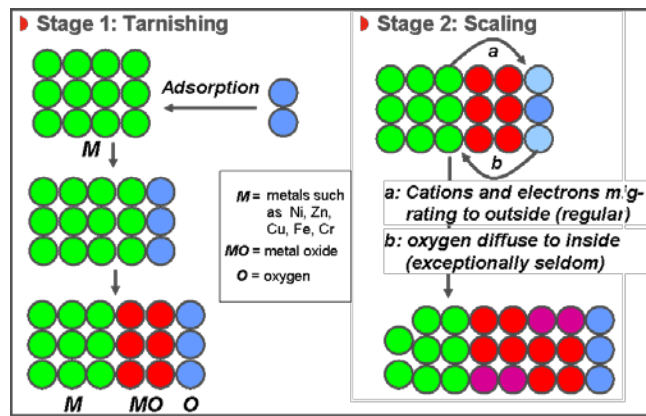

Fig. 2 Overview of the corrosion mechanism

DESCRIPTION OF TESTING

To evaluate the corrosion resistance of common PWB surface finishes four different tests were designed, simulating a reasonable range of corrosion influences. The selected tests differ with respect to corrosion atmosphere and corrosion medium. The following Tests were used for this investigation:

- SO₂-Gas-Test
- Kesternich Test
- Salt-Spray Test
- Surface Insulation Resistance Test

Table 2 presents an overview of the selected surface finishes.

To obtain comprehensive results about the surface changes every test is conducted for up to 6 cycles. In the industry standards like DIN 50021/ ISO 9227 corrosion testing is usually done for one or two cycle. In the following sections the corrosion tests and the surface finishes are described in more detail.

Test Vehicles

For the SO₂-Gas Test, Kesternich Test and Salt-Spray Test an Atotech corrosion test vehicle was used, as shown in Figure 3. For the SIR Test a standard IPC Multi-Purpose test board was employed, shown in Figure 4. In the analysis only the test vehicle designs identified in the figures as “detail” were used to evaluate the corrosion resistance of the surface finishes.

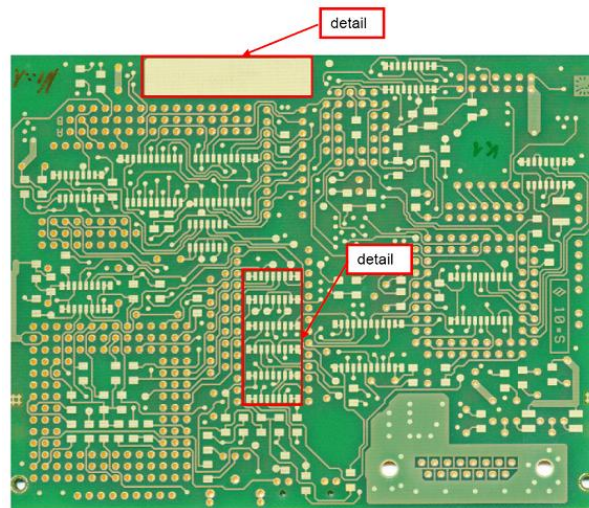

Fig. 3 Atotech corrosion test vehicle

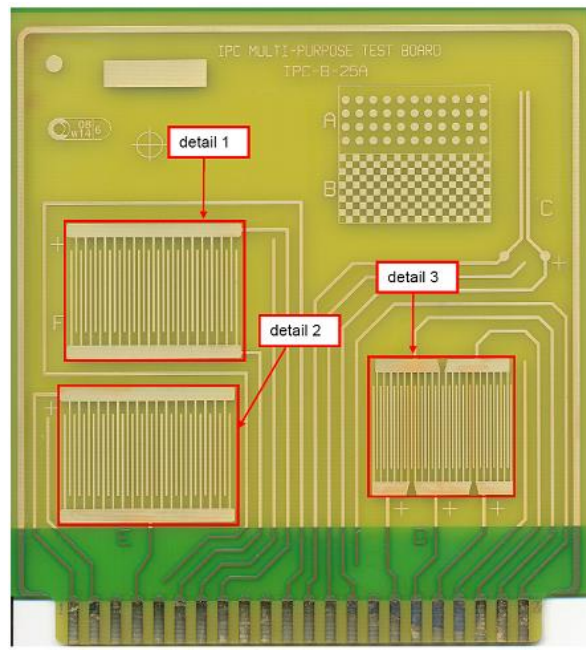

Fig. 4 IPC Multi-Purpose Test Board (IPC-B-25A)

Surface finishes

The test vehicles were fabricated with five different surface finishes:

- Electroless nickel/immersion gold (ENIG)
- Electroless nickel/electroless palladium/immersion gold (ENEPIG)
- Immersion silver
- Immersion tin
- OSP (organic solderability preservative)

Table 2 presents a summary of the surface finishes included in the investigations. As shown, two versions of ENIG and ENEPIG surface finish were examined, differing primarily in terms of the presences of phosphorus in the palladium layer.

Table 2: Summary of Surface Finish Specifications	
Surface Finish	Thickness
ENIG (7 - 9.5w%P) Med P	Ni 5 μ m / Au 0.07 μ m
ENIG (10-13w%P) High P	Ni 5 μ m / Au 0.07 μ m
ENEPIG (Ni-P / Pd / Au)	Ni 5 μ m / Pd 0.1 μ m / Au 0.03 μ m
ENEPIG (Ni-P / Pd-P / Au)	Ni-P 5 μ m / Pd-P 0.1 μ m / Au 0.03 μ m
Immersion Sn	Sn 0.8-0.9 μ m
Immersion Ag	Ag 0.3-0.5 μ m
OSP	Organic surface

SO₂-Gas Test

The SO₂-Gas test simulates a high humidity environment containing sulfur dioxide. The test is a standard corrosion test in the mobile phone industry. The Atotech corrosion test board, described in the previous section, was used for this test. According to DIN 50018:1997 and ISO 6988:1985, the SO₂-Gas Test is performed under the following conditions:

- Number of cycles: 6 consecutive
- Cycle duration: 24h
- SO₂ content: 10 ppm
- Temperature: 42°C
- Heating of desiccator in oven

Following all cycles, an optical inspection of a 5x5 mm area at a 10x magnification is used for evaluation. Pass/ fail criteria are based on the total counts of pores and corroded products generated. To illustrate, an example of the pass/ fail criterion is shown in the figure 5.

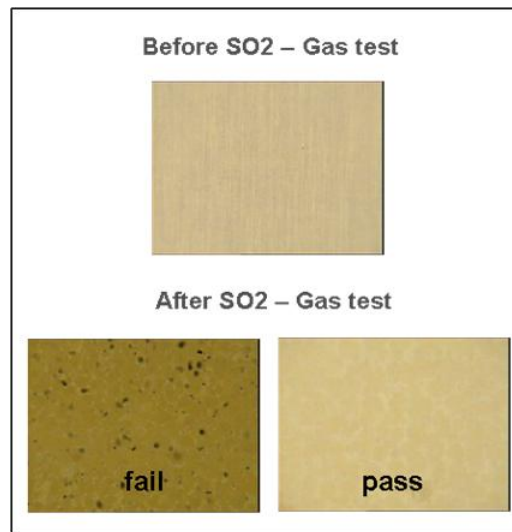

Fig. 5 Example of pass-fail criteria for the SO₂ Gas Test

Kesternich Test

The Kesternich Test is a standard, highly reproducible industrial test for protective coatings, particularly for evaluating the detrimental effects of acid rain. The test is based on DIN EN ISO 6988 and is conducted under the following conditions.

- Number of cycles: 6 (consecutive)
- Cycle duration: 24h
- Heating: 8h / 40°C / 100% rel. humidity
- Ventilation: 16h / RT / <75% rel. humidity
- SO₂ content: 200 ml / 300 l chamber

Equipment used for Kesternich testing is shown in Figure 6. The chamber design allows the testing of any test sample layout. After all test cycles are complete an optical inspection at 50x magnification is used for evaluation.



Fig. 6 Kesternich-test chamber

Salt-Spray Test

The Salt-Spray Test is an accelerated corrosion test, which simulates a corrosive attack in a harsh marine climate. The procedure is also a standard test in the electronic industry, based on the DIN 50021/ ISO 9227. According to this standard, the test was performed under the following conditions:

- Test solution NaCl*: 50 g/l
- Test solution pH*: 6.0-7.5
- Temperature: 35°C
- Spray volume:: 1.5 ml/h (16h average)
*makeup; no adjustment

Figure 7 shows typical equipment used for this testing.



Fig. 7 Salt-Spray Test Chamber

Because of the multivariable layout of the chamber, testing of any sample layout is possible. After exposure in the test chamber, the samples were optically inspected at 50x magnification.

Surface Insulation Resistance (SIR) Test





The SIR Test is a common investigation measuring the electrical resistance between two conductors. The objective of the test is to assess the potential failure of PWB assemblies through corrosion and other processes associated with ionic contamination. In a case of electrical voltage between the conductive lines the contamination (salts, humidity) functions as an electrolyte and is, therefore, conductive. The electrical resistance is reduced and short-circuiting is eventually possible.

For the SIR Test an IPC-B-24-380 test vehicle with 520- μ m lines and spaces was used. The samples were evaluated based on two pass/fail criteria: (1) the dendrite growth must be less than 25-percent of spacing and (2) the resistance must be greater than 10^8 Ohms. The test conditions were as follows:

- Temperature: 85°C
- Relative Humidity 85%
- Duration: 7 days
- Bias: 50V

TESTING RESULTS

Every corrosion test was performed for every single surface finishing for multiple cycles. The guidelines for qualifying the corrosion effects on the surface were as follows:

-  No surface tarnish
-  Minor surface tarnish
-  Major surface tarnish
-  Minor surface corrosion
-  Major surface corrosion

Testing Results – SO₂ Gas Test

The samples from the SO₂ Gas Test were analyzed in the following exposure conditions:

- As received (AsR) without SO₂ exposure
- After one reflow without SO₂ exposure
- As received (AsR) with SO₂ exposure
- After one reflow with SO₂ exposure

Figure 8 shows the results for the two ENIG and two ENEPIG surface finishes. After one reflow the finishes show no corrosive changes. Only the ENEPIG (Pd-Phosphor) surface is slightly tarnished. Also in the states, “AsR SO₂” and “One Reflow SO₂”, the corrosion resistance of the layers remains largely unchanged. Only the ENIG (medium P) and ENEPIG (Pd-P) finishes exhibit slight corrosion.

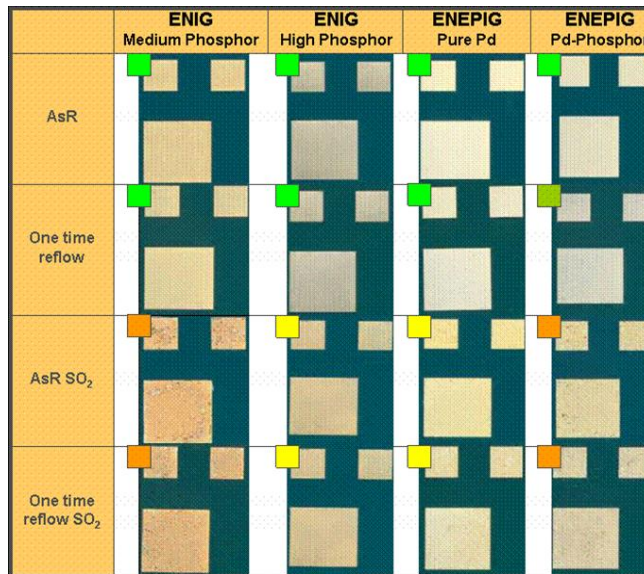

Fig. 8 SO₂ Gas Test results for ENIG and ENEPIG

In Figure 9 the SO₂ Gas Test results for immersion silver, immersion tin and OSP finishes are presented. As shown, a single reflow exposure did not pose a problem for any of the three finishes. However, it is apparent that the corrosion resistance of immersion silver was fully destroyed in the presence of small amounts of SO₂. The OSP surface also exhibits unsatisfactory results under SO₂ gas influence. By comparison, the immersion tin surface finish passed the test with relatively good results. After one reflow with SO₂ exposure the immersion tin surface was significantly tarnished, but the corrosion resistance was still maintained.

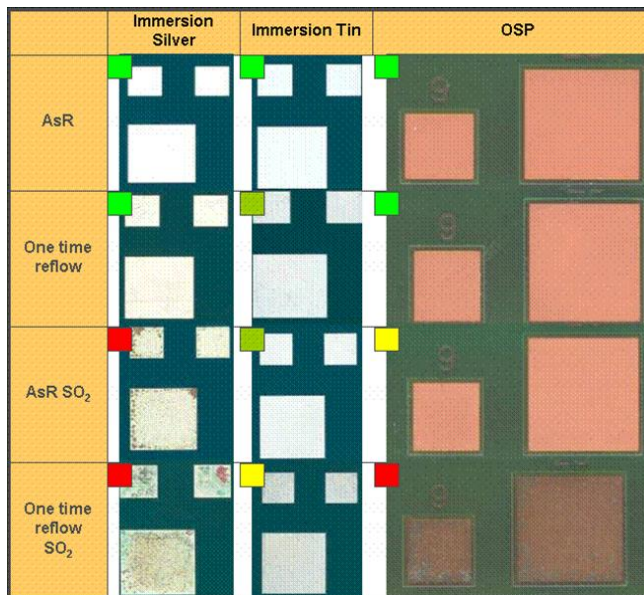

Fig. 9: SO₂ Gas Test results for immersion silver, immersion tin and OSP

Testing Results – Kesternich Test

In the Kesternich Test the performance of the selected surface finishes was evaluated over six cycles. Figure 10 summarizes the results for the ENIG and ENEPIG surface finishes.

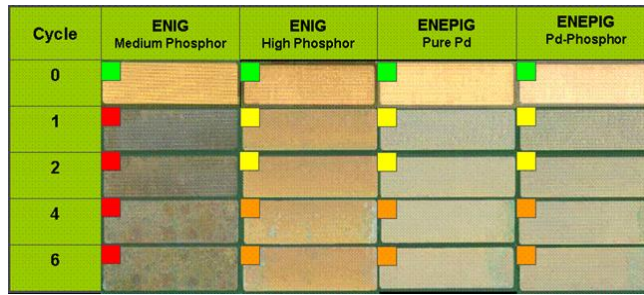

Fig. 10 Appearance of coupons after the Kesternich Test for ENIG and ENEPIG finishes

In general, the ENEPIG surface exhibited good corrosion resistance in this simulated harsh industry environment. Through the sixth cycle the ENEPIG surface displayed only slight corrosion. However, the two ENIG finishes performed quite differently under the applied conditions. The ENIG surface with medium phosphorus was totally corroded after only one cycle. By comparison, the ENIG surface with the high phosphorus content was only slightly corroded, even after the last test cycle. This result supports the theory that higher phosphorus content in the nickel deposit plays a critical role in maintaining the overall corrosion resistance.

The Kesternich Test results for the immersion silver, immersion tin and OSP finishes are presented in Figure 11.

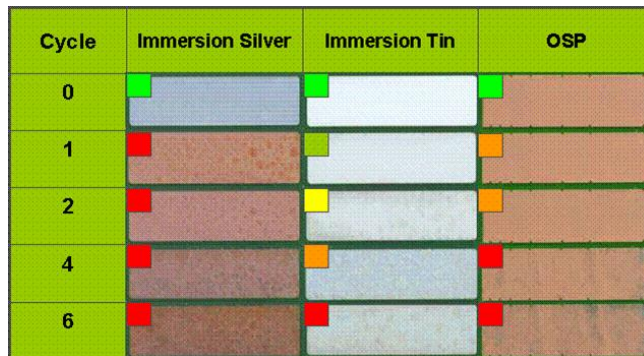

Fig. 11 Appearance of immersion silver, immersion tin and OSP coupons after the Kesternich Test

As shown in the figure, immersion silver achieved only a very limited level of corrosion resistance. After only one cycle (day) the original surface was already degenerated. By comparison, both OSP and immersion tin showed significantly less deterioration with increasing number of cycles. The immersion tin finish, in particular, exhibited excellent corrosion resistance in this test.

Testing Results – Salt Spray Test

The Salt Spray Test was performed over six cycles to simulate the worst possible exposure identified in the test protocol. Figure 12 summarizes the results of the Salt Spray Test for the ENIG and ENEPIG surface finishes.

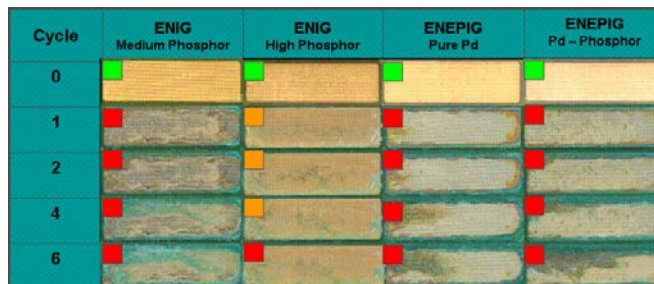

Fig. 12 Appearance of coupons after the Salt Spray Test for ENIG and ENEPIG finishes

Because the Salt Spray Test simulates a very harsh marine environment, the corrosion on the surfaces can be significant, as clearly shown on the ENIG (Medium P) and on both ENEPIG surfaces. However, by comparison, the ENIG finish with high phosphorus content showed only slight evidence of corrosion through the fourth cycle. This finding again supports the highly positive influence of the higher phosphorus content in the nickel layer for the corrosion resistance of ENIG.

Figure 13 presents the results of the Salt Spray Test for the immersion silver, immersion tin and OSP surface finishes.

Cycle	Immersion Silver	Immersion Tin	OSP
0			
1			
2			
4			
6			

Fig. 13 Appearance of immersion.silver, immersion.tin and OSP coupons after the Salt Spray Test

Similar to the performance of the ENIG finish with high phosphorus content, the immersion tin surface offers some corrosion resistance through the second test cycle. However, under the harsh conditions of the Salt Spray Test the immersion silver and OSP finishes provide inadequate corrosion protection.

Test Results – Surface Insulation Resistance (SIR) Test

As previously mentioned, results from the SIR test indicate the presence of ionic contamination. In addition to measuring the SIR, an optical inspection (50x magnification) was performed to observe any dendritic growth. Because OSP is a non-metallic layer (i.e. insulator) SIR investigations of this surface finish are not meaningful.

Figure 14 shows the visible results of SIR testing for the following conditions:

- As received (AsR)
- After three days and 3x reflows
- After seven days and 3x reflows

As shown in the figure, dendritic growth was not visible for any tested samples.

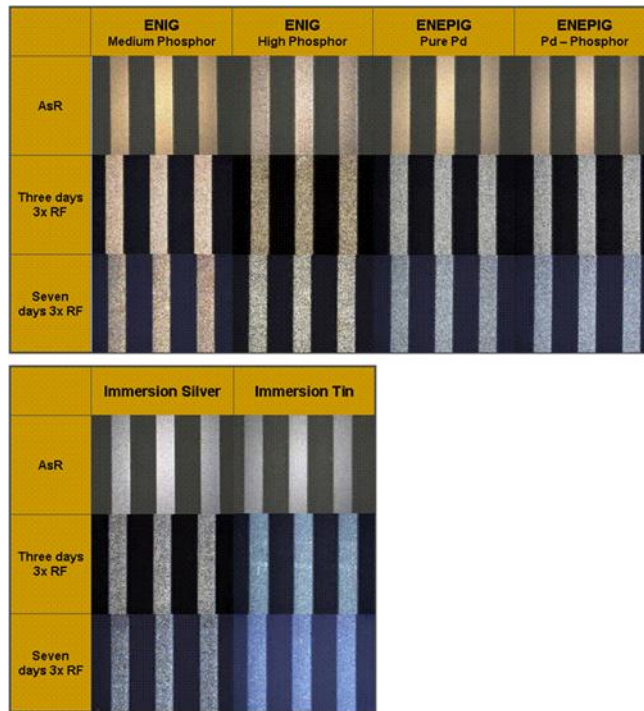

Fig. 14 Detail view of the SIR test results for ENIG and ENEPIG (above) and for immersion silver and immersion tin (below)

Figure 15 shows the measured insulation resistance for each surface finish sample for the following conditions:

- As received plus four days
- As received plus four days, followed by 3x reflow, followed by four hours at 155°C.

As shown in the figure, both the automotive OEM specification (500 MOhm) and the IPC specification (100 MOhm) were passed by all tested surface finishes.

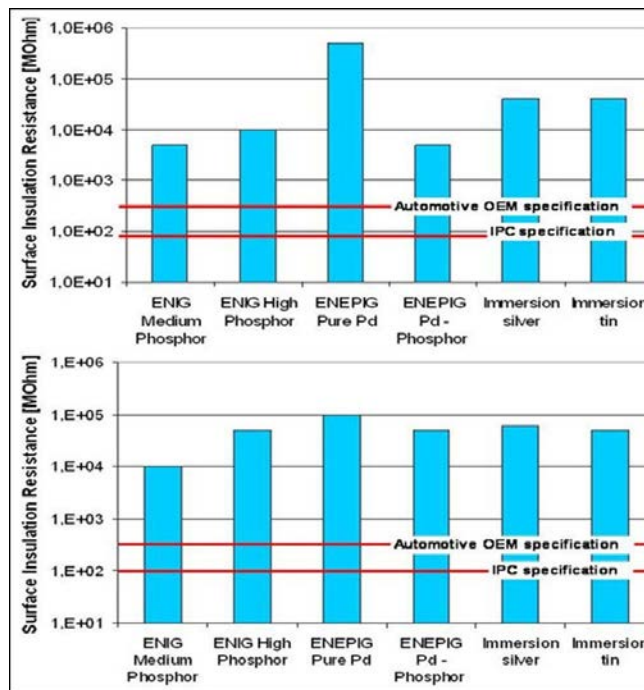

Fig. 15 Summary of the measured SIR as received plus four days (above) and after four days followed by 3x reflow, followed by four hours at 155°C (below)

DISCUSSION

Four different test methodologies were employed in this investigation to examine the susceptibility of surface finishes to corrosion. In this section the results for the seven different common surface finishes are summarized and discussed.

ENIG (Medium Phosphorus)

The tests performed in this study have shown that, as a surface finish, ENIG with medium phosphorus content in the electroless nickel deposit has limited corrosion resistance. As such, an additional protection of the surface against harsh environmental influences would be necessary. The following diagram summarizes the corrosion test results.

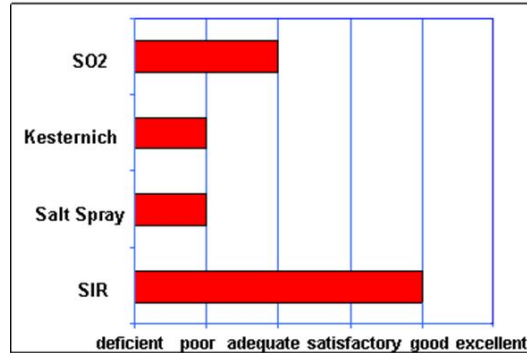

Fig. 16 Corrosion test results for ENIG (Medium P)

Because of its good contact resistance characteristics ENIG (Medium P) is commonly used for mobile phone keypads and for heat seal applications. Because of its Al-wire bonding capability and multiple Pb-free solderability, this finish is widely accepted, especially in the automotive and consumer electronics segments.

ENIG (High P)

The ENIG surface finish with increased phosphorus content in the nickel layer clearly achieved better corrosion resistance results, as summarized in Figure 17.

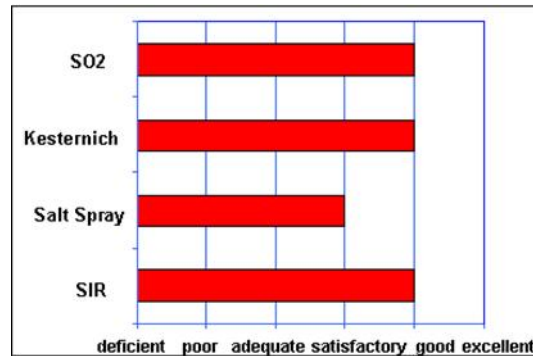

Fig. 17 Corrosion test results for ENIG (High P)

As shown, ENIG (High P) performed well in all corrosion tests. Therefore, it has found applications on mobile phone keypads that require a higher degree of corrosion protection.

The primary assembly procedures are very similar to those for ENIG (Medium P). The Al-wire bondability and multiple Pb-free solderability are the main characteristics of this finish. Its suitability in heat seal and key pad (mobile phone) applications is an added benefit of ENIG (High P).

ENEPIG (Pure Pd)

Analysis of the test results has shown that ENEPIG with a pure palladium deposit performed comparably to ENIG (High P) in terms of its corrosion resistance. As shown in Figure 18, its performance in the Salt Spray Test was slightly lower, compared to ENIG (High P). In a direct comparison to ENIG (Medium P), the ENEPIG (Pure Pd) performed much better in both the SO₂-Gas Test and the Kesternich Test.

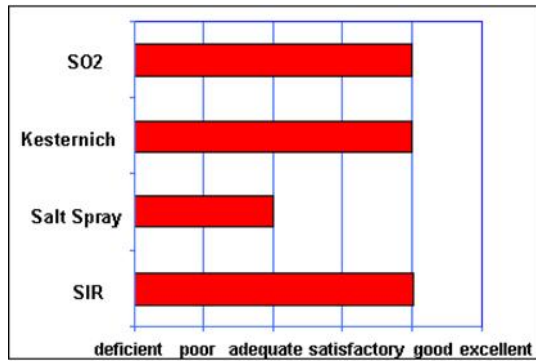

Fig. 18 Corrosion test results for ENEPIG (Pure Pd)

ENEPIG (Pd-Phosphorus)

The ENEPIG (Pd-P) finish did not perform as well in the SO₂ Test as the ENEPIG with the pure palladium layer. Otherwise, the two finishes performed similarly in terms of corrosion resistance. A summary of the test results is given in figure 19.

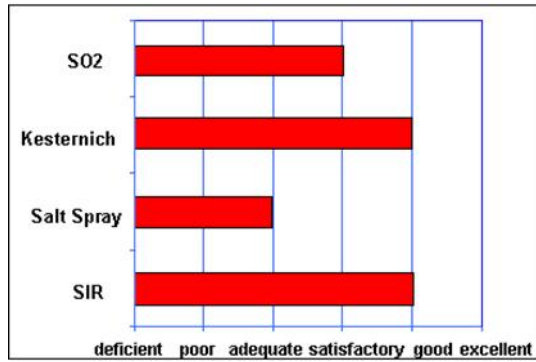

Fig. 19 Corrosion test results for ENEPIG (Pd-P)

Immersion Silver

Based on the testing performed, immersion silver provided the lowest level of corrosion resistance of the surface finishes tested. As such, an additional corrosion protection against environmental influences would be necessary. Figure 20 summarizes the corrosion test results for the immersion silver finish.

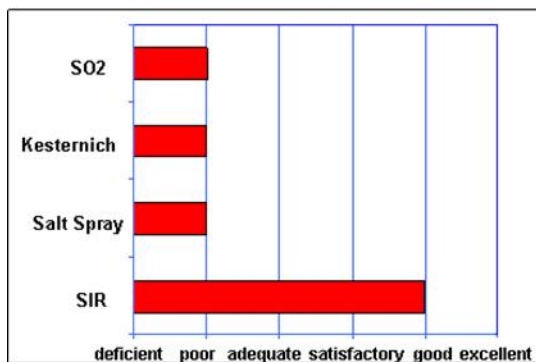

Fig. 20: Corrosion test results for immersion silver

Immersion Tin

Because of its suitability for both eutectic and Pb-free soldering, as well as compliant pin assembly applications, immersion tin satisfies a wide range of performance requirements for PWBs in the automotive industry. One important reason for its widespread use in the automotive sector is the excellent corrosion resistance of the surface. Overall, no finish in the test series delivered better results. Figure 21 shows a summary of the test results for the immersion tin finish.

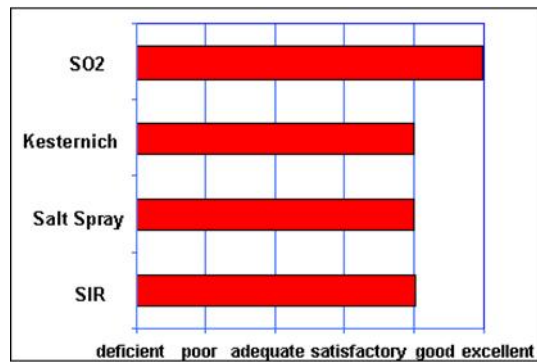

Fig. 21 Corrosion test results for immersion tin

Three primary mechanisms protect the immersion tin surface against harsh environmental influences. The first one mechanism is called passivation and is illustrated in Figure 22.

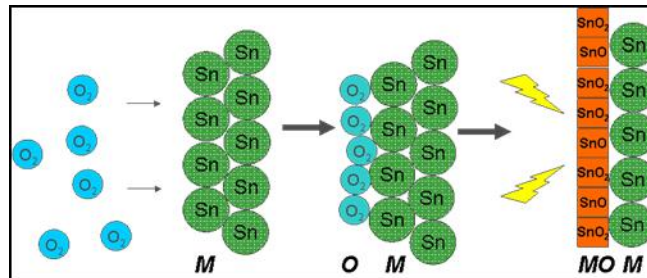

Fig. 22 Passivation of the immersion tin surface [1]

In the first step, oxygen molecules from the air are adsorbed onto the tin surface. In a second step, the oxygen molecules react with the tin atoms and create a thin, pore-free tin-oxide layer (SnO/SnO_2), providing the tin surface with a high degree of corrosion resistance.

The second mechanism is the build up of a high hydrogen overvoltage by the tin oxide formation. This “hydrogen overvoltage” provides the immersion tin surface with a high resistance against acidic environmental influences. [1]

The third step is the formation of the copper tin IMC this copper tin alloy (bronze) is known as very corrosion resistant.

OSP

As the only non-metallic finish examined, OSP was found to provide limited corrosion resistance. The tests have shown that the corrosion protection breaks down if the OSP surface becomes damaged. Therefore an additional corrosion protection after assembly such as sealing with lacquer, capsulation or a close package of the electronic system is advisable. Figure 23 shows a summary of all corrosion test results for the OSP surface.

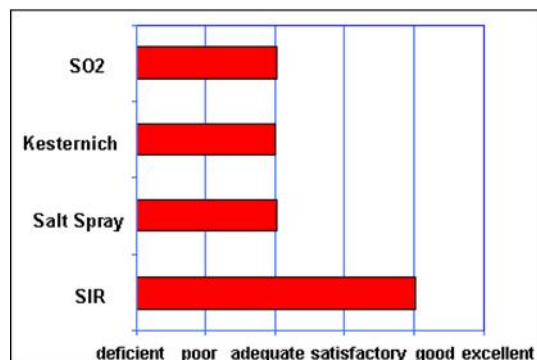

Fig. 23 Corrosion test results for OSP

CONCLUSIONS

As shown in this evaluation, each surface finish exhibits different corrosion protection characteristics in the various harsh environments. Typically, products used in military, automotive and medical applications have higher corrosion resistance requirements than products with lower lifetime or performance expectations, such as consumer or office products. In nearly all segments of the electronics industry, the increasing variety of raw materials, manufacturing processes and performance specifications pose a wide range of factors influencing the requirements for corrosion resistance.

Figure 24 gives a comprehensive assessment of the corrosion protection performance of all tested final finishes.

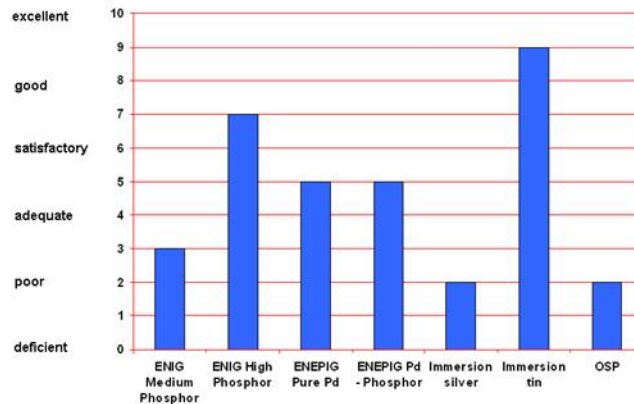

Fig. 24 Summary of corrosion test results for tested finishes

As shown in the figure, immersion tin, ENIG (High P) and ENEPIG provide a higher level of corrosion protection. By comparison, OSP, ENIG (Medium P) and immersion silver deliver only limited corrosion resistance. For protection against corrosion, selection of the appropriate surface finish must include consideration of all product-specific aspects. Therefore, a close cooperation with all segments of the supply chain is essential.

REFERENCES

1. Dr. P. Keller, "Elektrochemische und oberflächenanalytische Untersuchungen zur anodischen Dickschichtbildung auf Zinn und Kupfer/ Zinn – Legierungen "; Professional dissertation, January 2006.
2. C. Xu, K. Demirkan, G. Derkits, "Corrosion Resistance of PWB Final Finishes"; Alcatel – Lucent, July 2006
3. David H. Ormerod, "Immersion tin as a high performance solderable finish for fine pitch PWBs"; Article in Circuit World, 2000
4. K. Johal, H.J. Schreier, "Novel Immersion Tin Finish for Multiple Soldering of Surface Mount Packages"; IPC, 2000
5. Ph. D. R. Schueller, "Creep corrosion on lead free printed circuit boards in high sulfur environments" ; SMTA Int'l Proceedings, October 2007
6. J. L. Jostan, W. Mussinger, A. F. Bogenschütz, "Korrosionsschutz in der Elektronik", Eugen G. Leuze Verlag, May 1986



Corrosion Resistance of different PCB Surface Finishes in Harsh Environments

Mustafa Özkök , Atotech Deutschland GmbH
Joe McGurran, Atotech Deutschland GmbH
Hugh Roberts, Atotech USA Inc.
Kenneth Lee, Atotech China
Guenter Heinz, Atotech Deutschland GmbH



TOTAL

Contents

- Introduction
 - Corrosion resistance in electronics industry
 - The importance of corrosion resistance for surface finishes
- Definition of corrosion
- Test description
 - General
 - SO₂ – Gas Test
 - Kesternich Test
 - Salt – Spray – Test
 - Surface Insulation Test (SIR)
- Test results
 - SO₂ – Gas Test
 - Kesternich Test
 - Salt – Spray – Test
 - Surface Insulation Test (SIR)
- Discussion of results
 - ENIG
 - ENEPIG
 - Immersion silver
 - Immersion tin
 - OSP
- Summary



Introduction

Corrosion Resistance in Electronics Industry
Corrosion Resistance of Finishes – Importance

Corrosion Resistance in Electronics Industry

- ▶ Every year corrosion damage produces costs in a value of 4% of the German gross domestic product (~100 billion €)*
- ▶ Half of all damage causes in a modern automobile comes from the electronic system; mainly damage by corrosion*

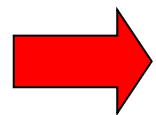

Corrosion resistance has the intention to increase the reliability of electronic systems, reduce costs and increase safety.

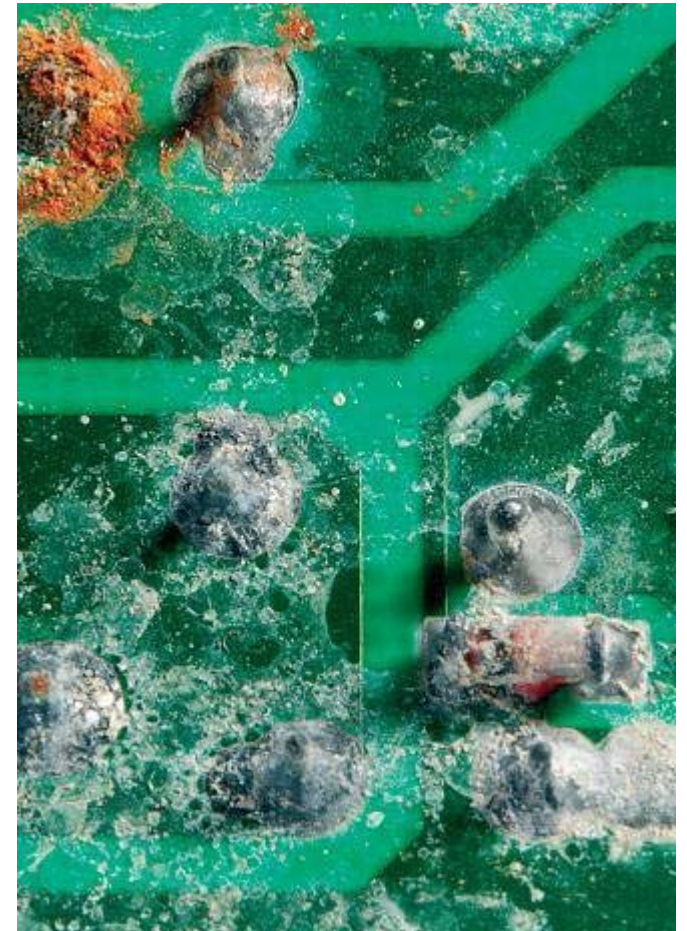

Corrosion prevention avoids uncontrolled damage!

Why is corrosion resistance of finishes so important today?

- ▶ Used metals only in thin films → small corrosion loss has a pronounced effect on their performance
- ▶ Increase ecological requirements
- ▶ Legal safety requirements of electronic products
- ▶ Legal requirements regarding minimum guarantee of electronic products
- ▶ Competition in automotive sector resulted in increase of car warranties (actually 3-5 years guarantee)



Corrosion prevention means cost reduction!

Corrosion Resistance of Surface Finishes - Importance

Why is corrosion resistance of surface finishes so important today?

- ▶ Solder Pads and through holes are usually covered by Solder after assembly. On these areas the tin solder works at the same time as an corrosion protection in the field.
- ▶ But there are also areas on a board where the only corrosion protection is done by the Surface Finish like
 - Vias
 - Microvias
 - Contact or Key Pad Areas
 - Electrical control Pads



Corrosion prevention means cost reduction!



Definition of corrosion

Definition of Corrosion

- ▶ Corrosion is an interaction process between a material, adjacent materials and environment.
- ▶ Corrosion is a physicochemical reaction of a system, which results in a change of the material properties
- ▶ Corrosion can cause defects by impairment of the material function, the adjacencies or the technical system.
- ▶ Corrosion in the final stage can result in the total loss of the system functionality
→corrosion break down

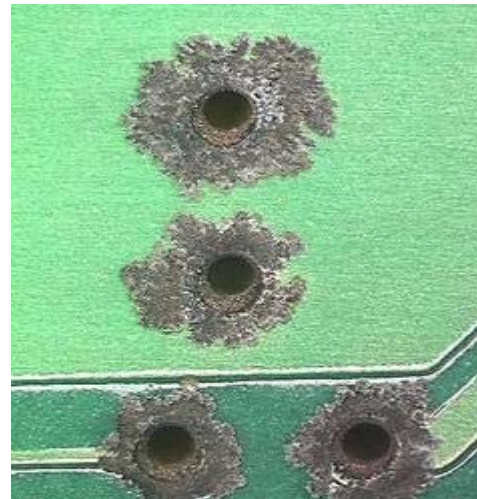

← Creep corrosion on ImAg protected vias*

HDD with ImAg surface finish. Cu_2S precipitates out of solution in a dendritic structure.*

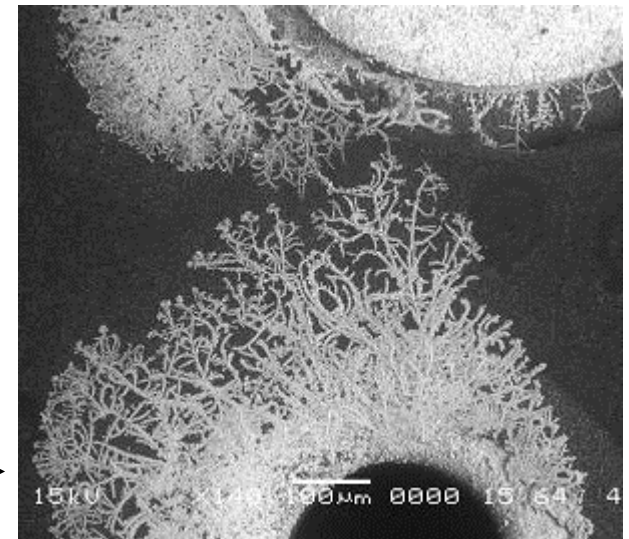

Corrosive influences

- ▶ High humidity
- ▶ High airflow
- ▶ Salts
- ▶ A high sulfur environmental
- ▶ The “wrong” combination of soldermask, fluxes and process conditions
- ▶ Environmental gases (e.g. NO_2 , Cl_2)
- ▶ A high galvanic potential difference between base and precious materials → current conduction
- ▶ PCB layout

Surface corrosion

Types of failures

The corrosion products can cause:

- ▶ *Shorts*
- ▶ *Nearby shorts*
- ▶ *Interruption*
- ▶ *Corroded switch contact areas*
- ▶ *Loose contact in the electronic.*

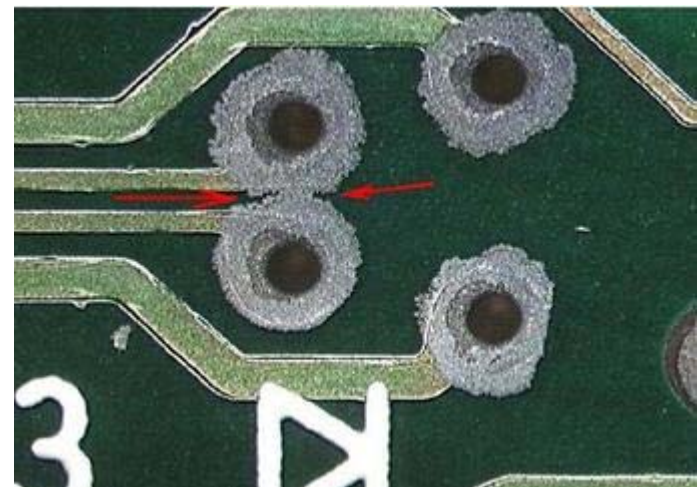

Creep corrosion field failure in high sulfur environment (bridging vias)*.

Electrochemical Series

Electrochemical Series					
	Reduce form	Oxidized form	+Number of electrons	Standard potential (E ₀ in Volt)	
	Ni	Ni ²⁺	+2e ⁻	-0,257	B a s e M e t a l s
	Sn	Sn ²⁺	+2e ⁻	-0,14	
	Sn ²⁺	Sn ⁴⁺	+4e ⁻	+0,15	P r e c i o u s M e t a l s
	Cu	Cu ²⁺	+2e ⁻	+0,34	
	Cu	Cu ⁺	+ e ⁻	+0,52	
	Ag	Ag ⁺	+ e ⁻	+0,80	
	Pd	Pd ²⁺	+2e ⁻	+0,915	
	Au	Au ³⁺	+3e ⁻	+1,50	

***If the electrochemical potential between two metals is high,
the risk of corrosion increases.***

Corrosion – Oxidation/Scaling

Stage 1: Tarnishing

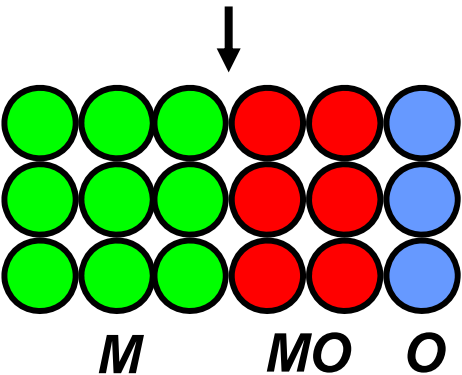
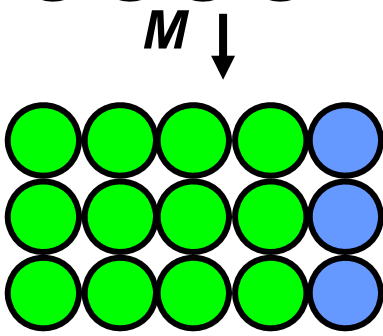
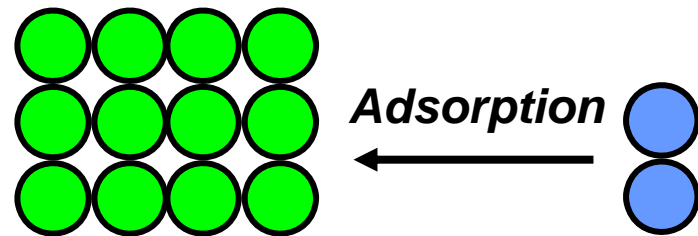

M = metals such as Ni, Zn, Cu, Fe, Cr
MO = metal oxide
O = oxygen

Stage 2: Scaling

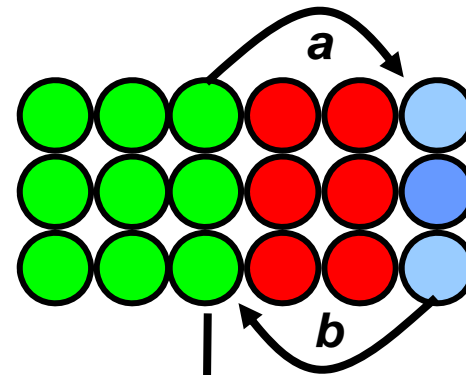

a: Cations and electrons migrating to outside (regular)

b: oxygen diffuse to inside (exceptionally seldom)

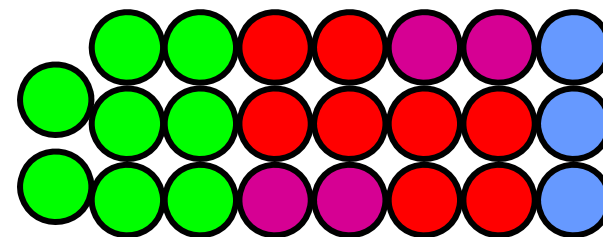



Test Descriptions

General

SO₂ – Gas Test

Kesternich Test

Salt – Spray – Test

Surface Insulation Test (SIR)

In order to evaluate the corrosion resistance of surface finishes four different corrosion tests were performed.

The selected corrosion tests differ regarding corrosion atmosphere and corrosion mediums.

Corrosion test	Surface finishing
▶ SO ₂ – Gas Test	▶ ENIG Medium Phosphor
▶ Kesternich Test	▶ ENIG High Phosphor
▶ Salt – Spray – Test	▶ ENEPIG Pure Pd
▶ Surface Insulation Test	▶ ENEPIG Pd – Phosphor
	▶ Immersion Silver
	▶ Immersion Tin
	▶ OSP

The aim of these tests are to benchmark surface finishes regarding corrosion resistance.

Desiccator SO₂ – Gas test

► Why SO₂ – Gas Test?

- Resistance in high humidity containing sulfur dioxide
- Test is a standard in the mobile phone industry

► Test conditions

- 10 ppm SO₂ / 24h / 42° C / >= 80% r.h.
- Heating of desiccator in oven

► Test sample layout

- Test coupon with 10 x 10 mm insulated pads
- No exposed Copper present, no edges from cutting

► Pass / fail criteria

- Optical inspection of a 5 x 5 mm area at 10x magnification
- Total counts of pores and corroded products

Before SO₂ – Gas test

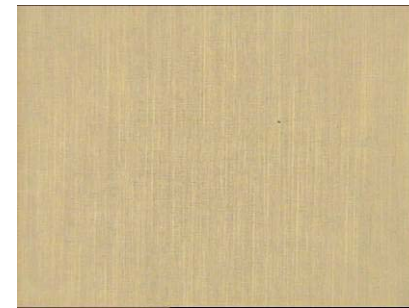

After SO₂ – Gas test

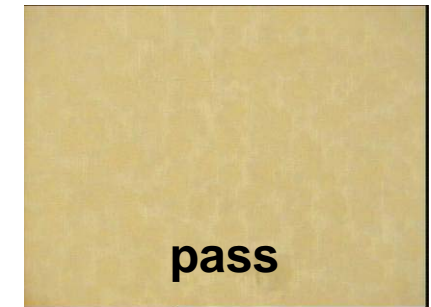
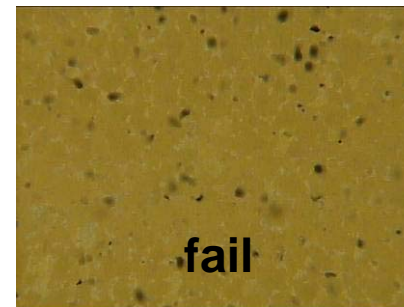

► Why Kesternich Test?

- Test for protective coatings / high reproducibility
- Resistance in high humidity containing sulfur dioxide

► Test conditions

- Based on DIN EN ISO 6988
- 200 ml SO₂ / 300 l chamber
- Heating: 24h / 40° C / 100% r.h.

► Test sample layout

- Any

► Pass / fail criteria

- Optical inspection at 50x

Kesternich – test chamber



▶ Test solution:

- Based on DIN 50021/ ISO 9227
- 50g/l NaCl
- pH: 6 – 7,5 (makeup; no adjustment)

▶ Temperature:

- 35° C

▶ Collected test solution:

- Averaged over 16h: 1,5 ml/h

▶ Test sample layout

- Any

▶ Pass / fail criteria

- Optical inspection at 50x

Salt – Spray - Test chamber



Surface Insulation Test (SIR)

- ▶ Why Surface Insulation Test?
 - Test for insulation resistance of base material / solder mask / tracks
 - Fear of electrical shorts
- ▶ Test conditions
 - 85° C; 85%r.h. for 7 days; 50V bias
- ▶ Test sample layout
 - IPC B-24 – 380 / 520 μm lines & spaces
- ▶ Pass / fail criteria
 - Dendritic growth smaller 25% of spacing
 - Resistance > 10^8 Ohm

Surface Insulation - Test board

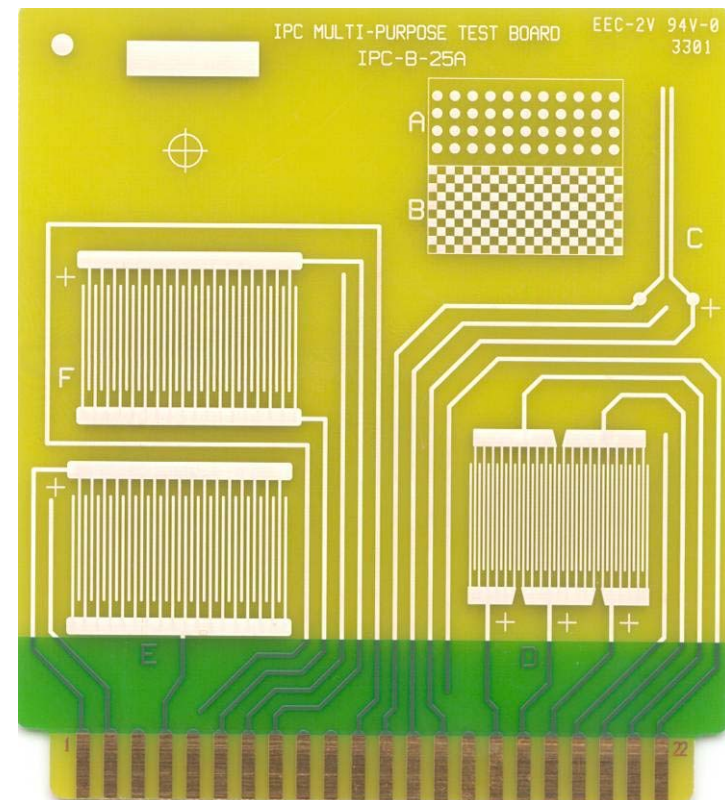



Test Results

SO₂ – Gas Test

Kesternich Test

Salt – Spray – Test

Surface Insulation Test (SIR)

	ENIG Medium Phosphor	ENIG High Phosphor	ENEPIG Pure Pd	ENEPIG Pd-Phosphor
AsR				
One time reflow				
AsR SO ₂				
One time reflow SO ₂				





















- Perfect surface
- Slightly tarnish surface
- High tarnish surface
- Slightly corrode surface
- Fully corroded surface, original surface degenerated





	Immersion Silver	Immersion Tin	OSP	
AsR				
One time reflow				
AsR SO ₂				
One time reflow SO ₂				

- Perfect surface
- Slightly tarnish surface
- High tarnish surface
- Slightly corrode surface
- Fully corroded surface, original surface degenerated

Test Results

Kesternich - Coupon

Cycle	ENIG Medium Phosphor	ENIG High Phosphor	ENEPIG Pure Pd	ENEPIG Pd-Phosphor
0				
1				
2				
4				
6				

 Perfect surface	 High tarnish surface	 Fully corroded surface, original surface degenerated
 Slightly tarnish surface	 Slightly corrode surface	



Test Results

Kesternich - Coupon

Cycle	Immersion Silver	Immersion Tin	OSP
0			
1			
2			
4			
6			

Perfect surface
 High tarnish surface
 Fully corroded surface, original surface degenerated
 Slightly tarnish surface
 Slightly corrode surface



Test Results

Salt Spray - Coupon

Cycle	ENIG Medium Phosphor	ENIG High Phosphor	ENEPIG Pure Pd	ENEPIG Pd - Phosphor
0				
1				
2				
4				
6				

■ Perfect surface
 ■ High tarnish surface
 ■ Fully corroded surface, original surface degenerated
■ Slightly tarnish surface
 ■ Slightly corrode surface



Test Results

Salt Spray – Coupon

Cycle	Immersion Silver	Immersion Tin	OSP
0			
1			
2			
4			
6			







Perfect surface	High tarnish surface	Fully corroded surface, original surface degenerated
Slightly tarnish surface	Slightly corrode surface	

Test Results

Surface Insulation Test

	ENIG Medium Phosphor	ENIG High Phosphor	ENEPIG Pure Pd	ENEPIG Pd – Phosphor
AsR				
Three days 3x RF				
Seven days 3x RF				

Test Results Surface Insulation Test

	Immersion Silver	Immersion Tin
AsR		
Three days 3x RF		
Seven days 3x RF		

Test Results Surface Insulation Test

4 Day; EF; as received

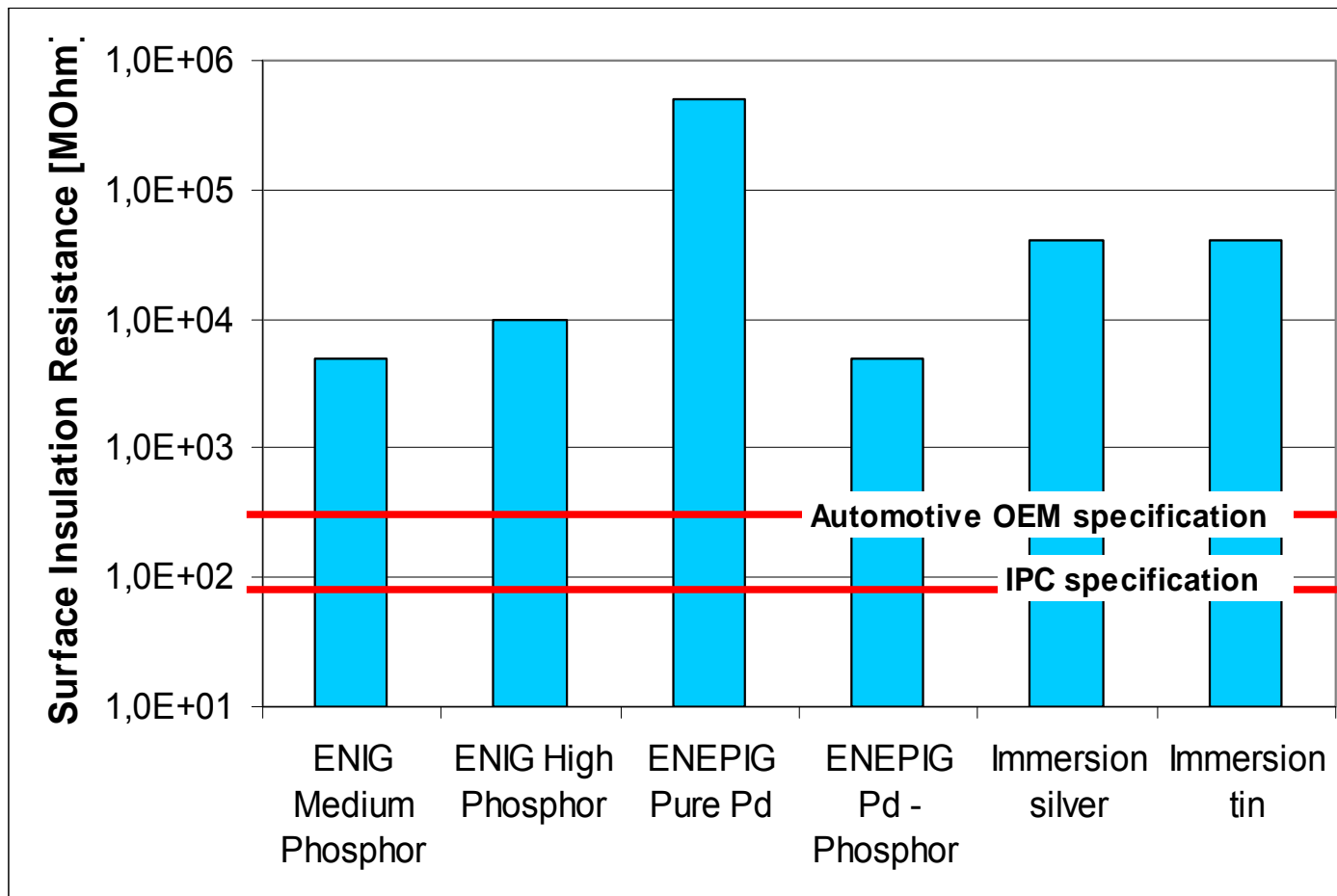

ENIG Medium Phosphor

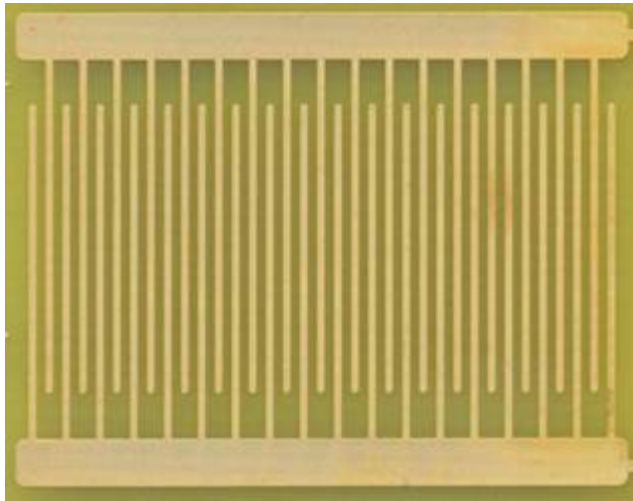

ENIG High Phosphor

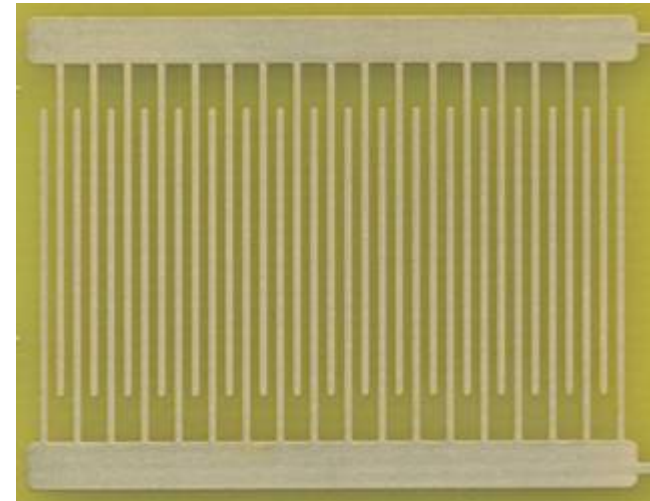

ENEPIG Pure Pd

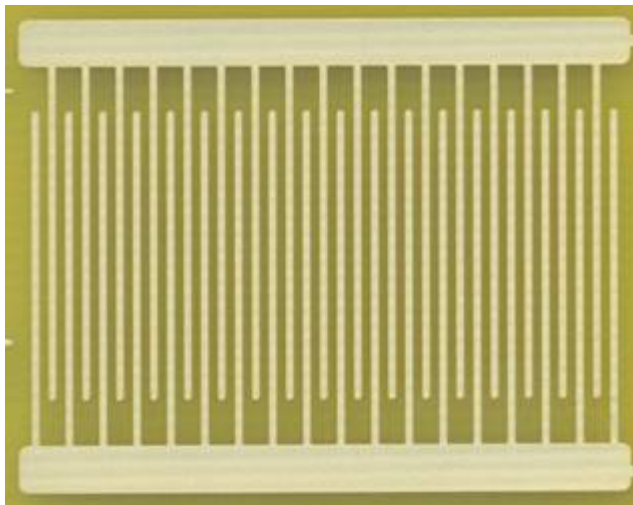

ENEPIG Pd - Phosphor

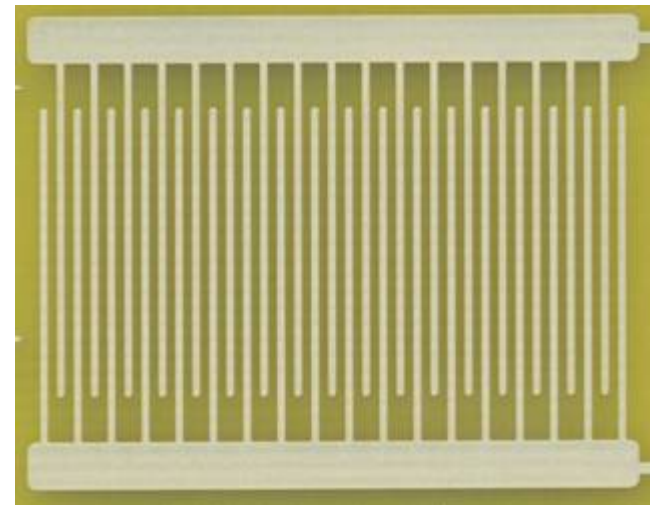

TEST RESULTS
APEX EXPO™ 2012
IPC Surface Insulation Test – 7 Day

Immersion Silver

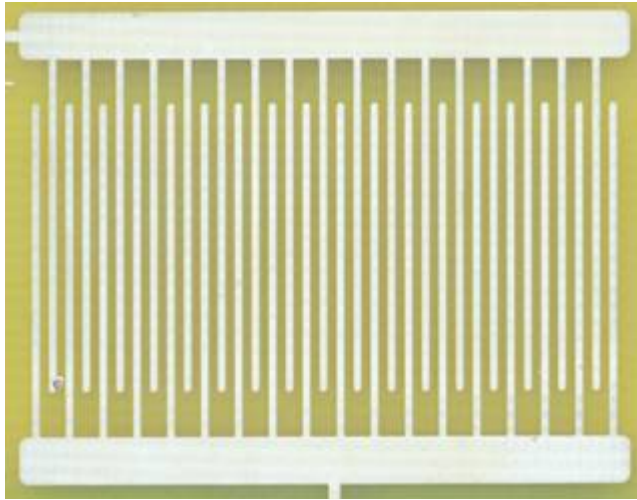

ASR

Immersion Tin

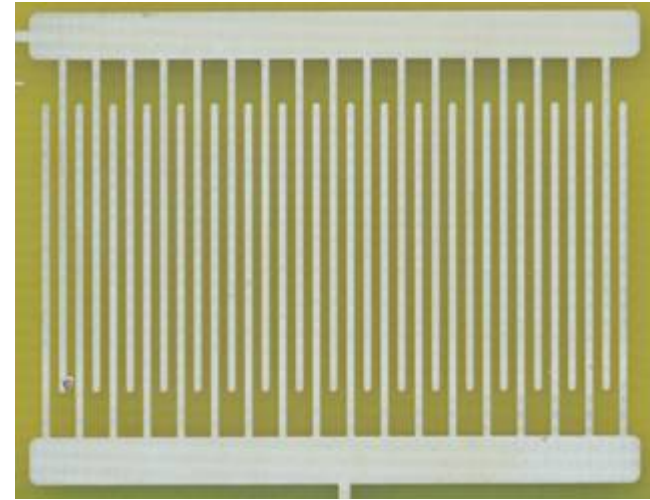

4 Day; EF; 3x reflow 155° C 4h

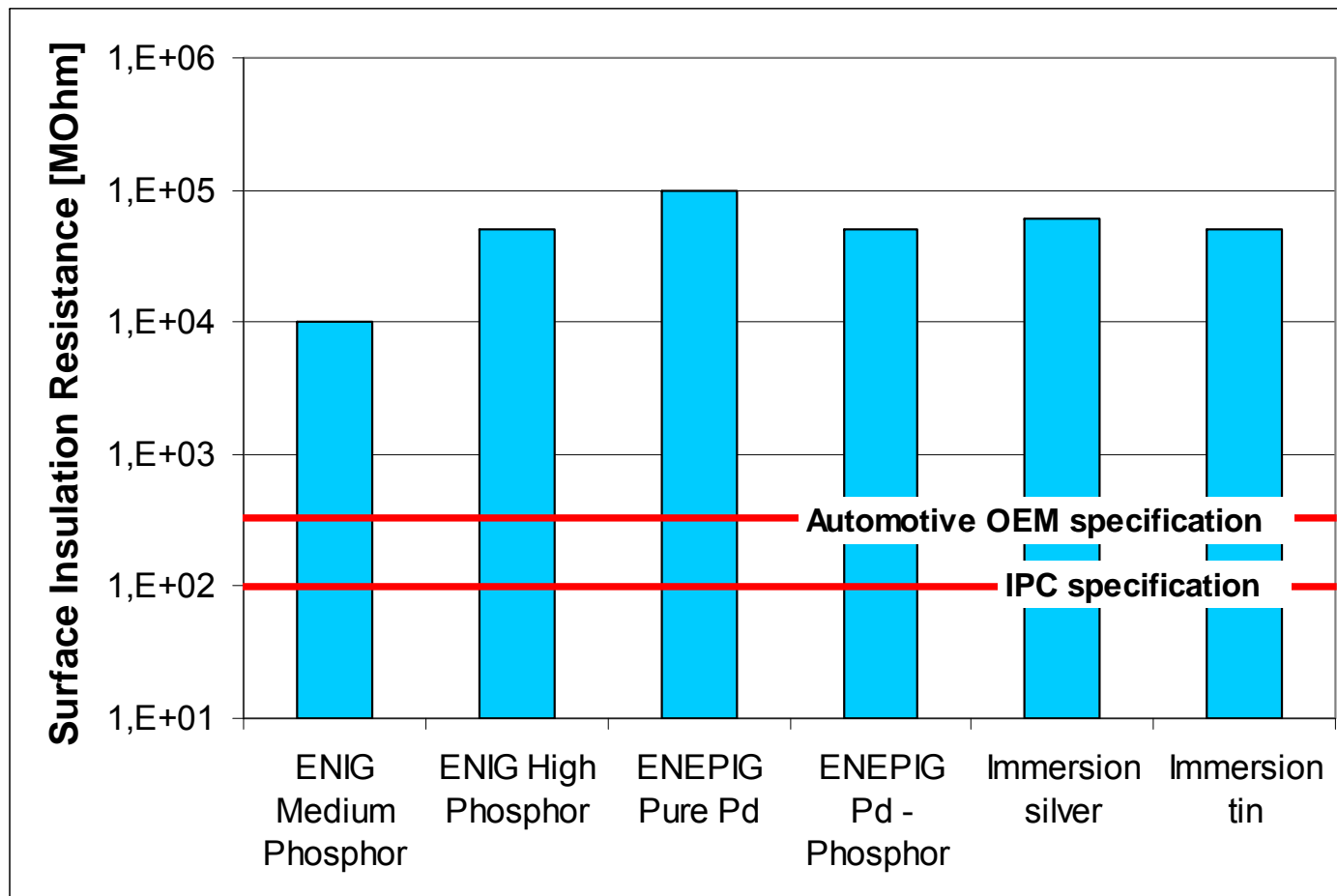

TEST RESULTS
APEX EXPO™ 2012
IPC
Surface Insulation Test – 7 Day;

ENIG Medium Phosphor. **2VDE. 155°**

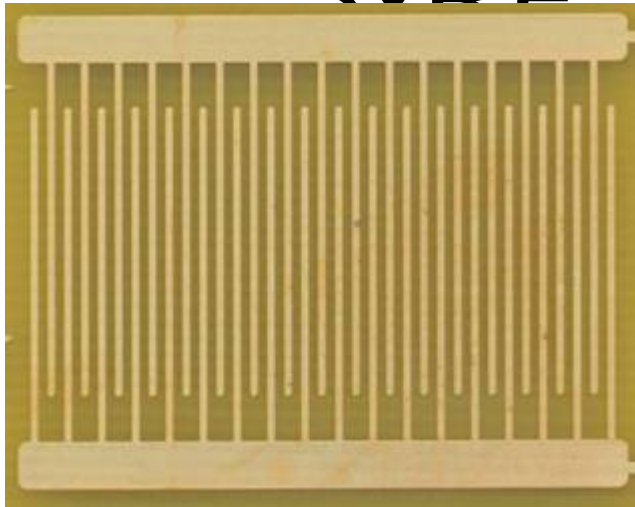

ENEPIG Pure Pd

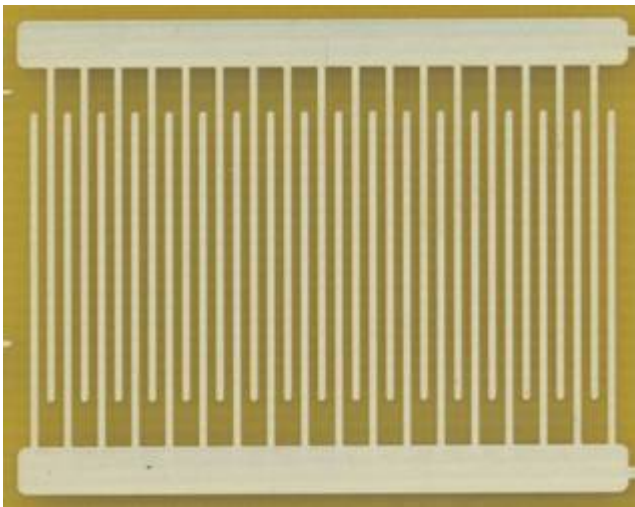

ENIG High Phosphor **0.4%**

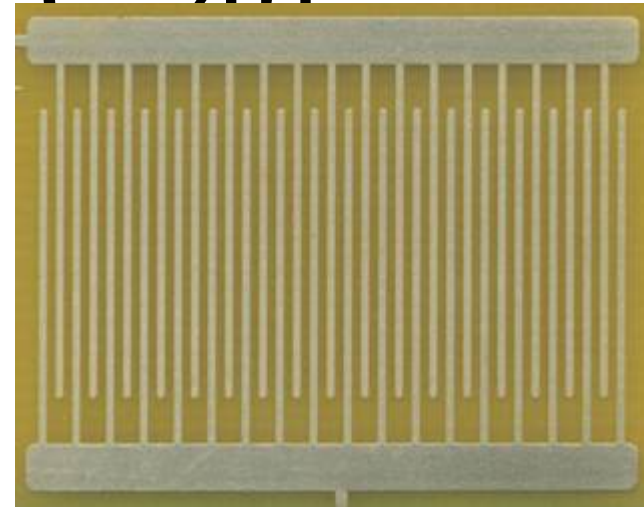

ENEPIG Pd - Phosphor

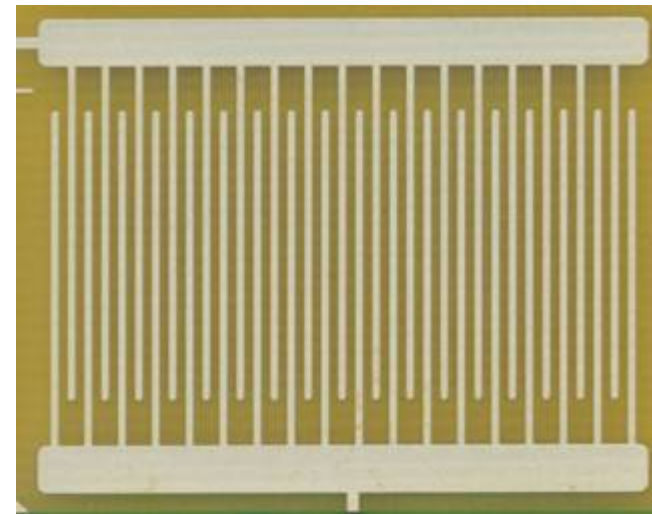

TEST RESULTS

Surface Insulation Test – 7 Day;

Immersion Silver

2VDE-155°

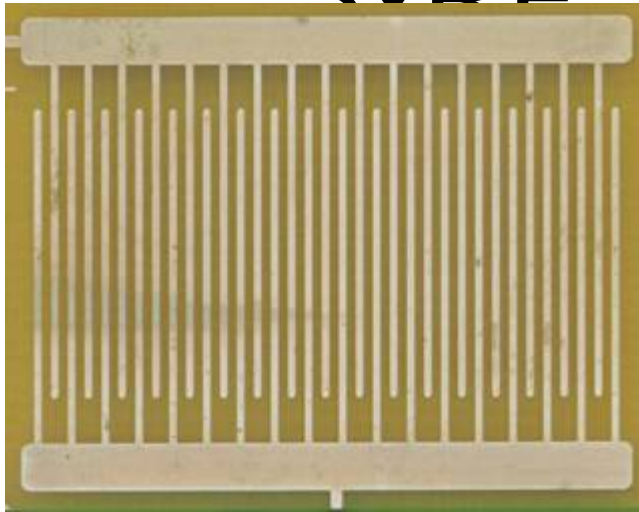

Immersion Tin

C-4h

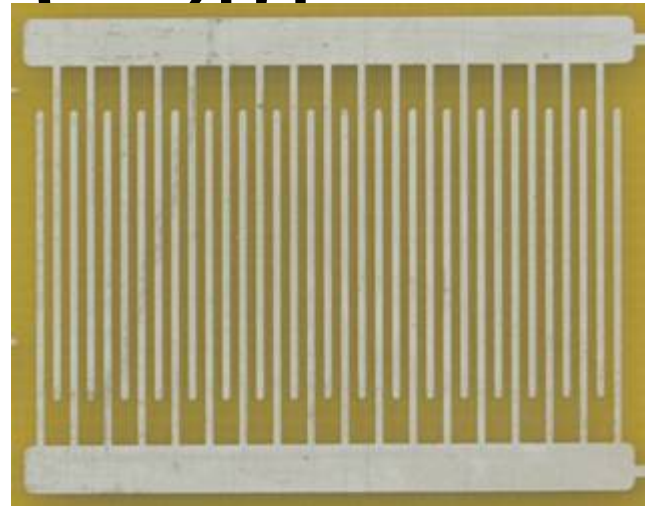



Discussion of results

SO₂ – Gas Test

Kesternich Test

Salt – Spray – Test

Surface Insulation Test (SIR)

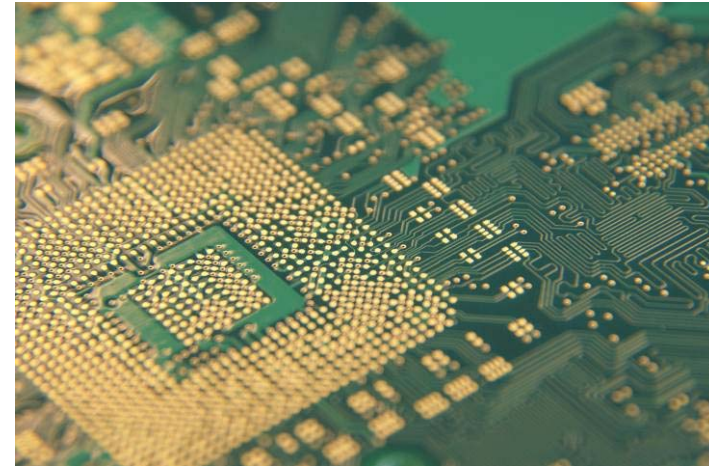

- ▶ Finishing with limited corrosion resistance.
- ▶ Additional protection against environmental influences is recommended.
- ▶ Increasing phosphor content in the nickel layer like HP Nickel improves the corrosion resistance

Industry used	<ul style="list-style-type: none"> ▶ Mobile phone industry ▶ Automotive industry ▶ Consumer electronics ▶ Industry electronics
Main assembly application	<ul style="list-style-type: none"> ▶ Key pad in mobile phones ▶ Al – wire bonding ▶ Multiple soldering lead free ▶ Heat seal application
Main features	<ul style="list-style-type: none"> ▶ High shelf life ▶ Good solder spread results ▶ High planarity

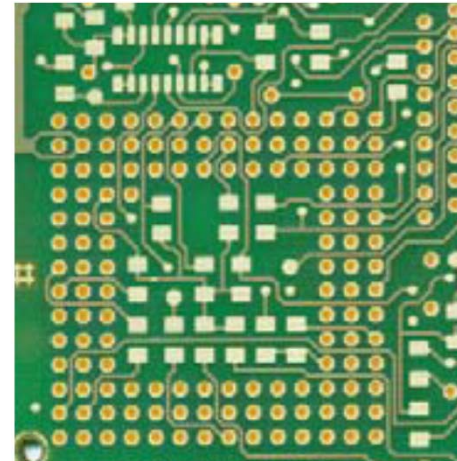

- ▶ Finishing with satisfactory – good corrosion resistance in all corrosion tests.
- ▶ Is used mainly in the mobile phone industry for contact switching.
- ▶ Increasing phosphor content in the nickel layer improves the corrosion resistance

Industry used	<ul style="list-style-type: none"> ▶ Industry electronics ▶ Mobile phone industry ▶ Automotive industry
Main assembly application	<ul style="list-style-type: none"> ▶ Key pad application (mobile phones) ▶ Al wire bondable surface ▶ Multiple soldering lead free ▶ Heat seal application
Main features	<ul style="list-style-type: none"> ▶ Long shelf life ▶ High corrosion resistance ▶ Good solder joint integrity

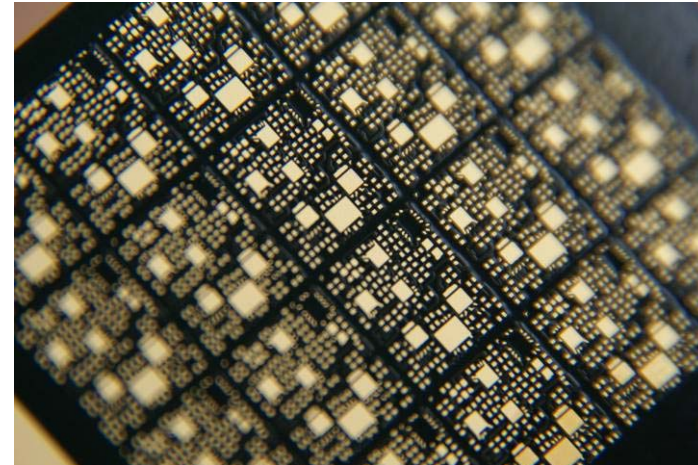

- ▶ Finishing with adequate – good corrosion resistance.
- ▶ In comparison to ENIG much better corrosion resistance for SO₂ – Gas Test and Kesternich Test

Industry used	<ul style="list-style-type: none"> ▶ Medical engineering ▶ Micro electronic industry ▶ IC-substrates ▶ LED light industry
Main assembly application	<ul style="list-style-type: none"> ▶ Au wire bonding ▶ Al wire bonding ▶ Multiple soldering lead free
Main features	<ul style="list-style-type: none"> ▶ High mechanical strength of solder joints with LF solder ▶ Good wire bond reliability ▶ Long shelf life ▶ Solderable with Eutectic and Lead free solder

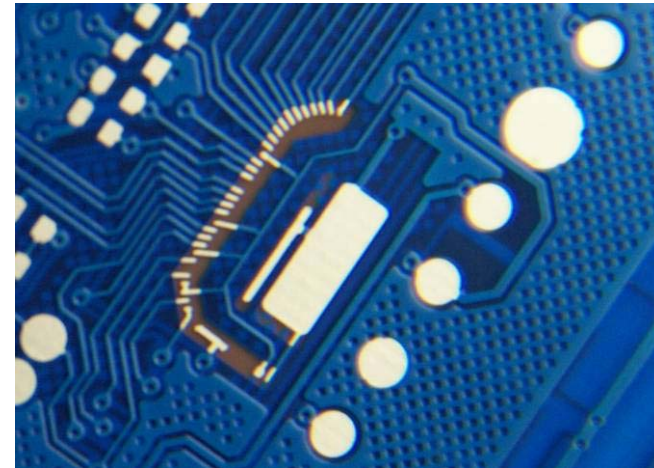

- ▶ Finishing with adequate - good corrosion resistance.
- ▶ In comparison to ENIG much better corrosion resistance for SO2 – Gas Test and Kesternich Test.

Industry used	<ul style="list-style-type: none"> ▶ Medical engineering ▶ Micro electronic industry ▶ IC-substrates ▶ LED light industry
Main assembly application	<ul style="list-style-type: none"> ▶ Au wire bonding ▶ Al wire bonding ▶ Multiple soldering lead free
Main features	<ul style="list-style-type: none"> ▶ Long shelf life ▶ Autocatalytic Ni and Pd deposition

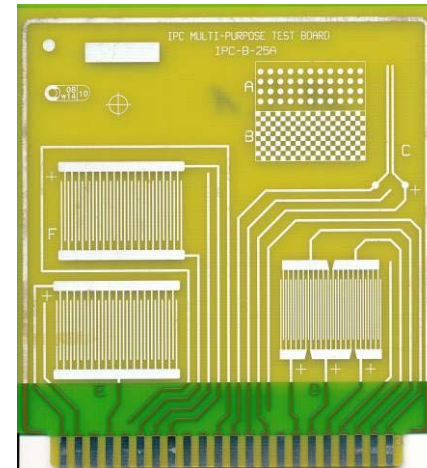

- ▶ Finishing with very limited corrosion resistance.
- ▶ Additional protection against environmental influences is necessary.

Industry used	▶ Consumer industry
Main assembly application	▶ Suitable for Lead free soldering
Main features	<ul style="list-style-type: none"> ▶ Long shelf life ▶ High planar surface ▶ Suitable for horizontal plating

Creep corrosion in high sulfur
environment (bridging vias)*

► Mild Clay Test

- Simulated a very harsh sulfur environment
- Creep corrosion after 8 days was observed*

► Mixed Flowing Gas Test

- Creep Corrosion observed after 2 days MFG**
- After 5 days fiber- assisted electrochemical migration was discovered**

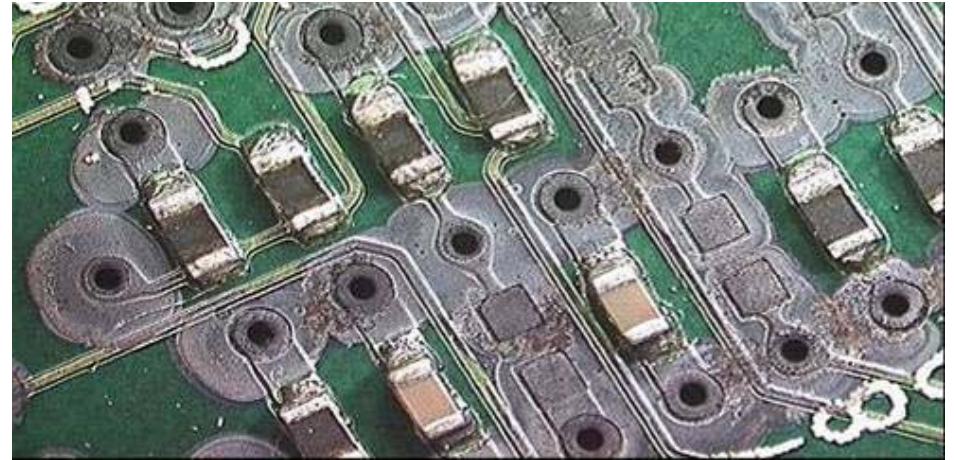

Creep corrosion after
MFG Test**

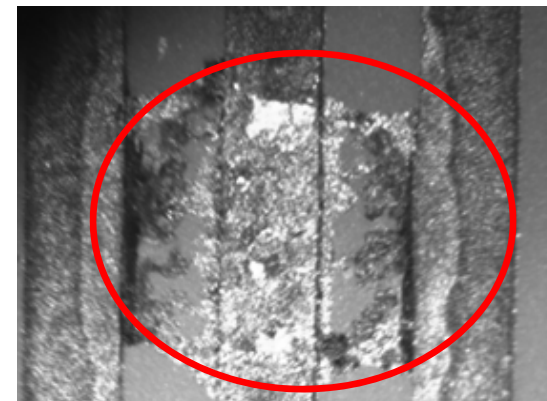

* Article SMTA: "Creep Corrosion on Lead Free PCBs in high sulfur environments", Orlando Florida, Oct. 2007

** C. Xu, K. Demirkan, G. Derkits: "Corrosion Resistance of PWB Final Finishes", Alcatel - Lucent

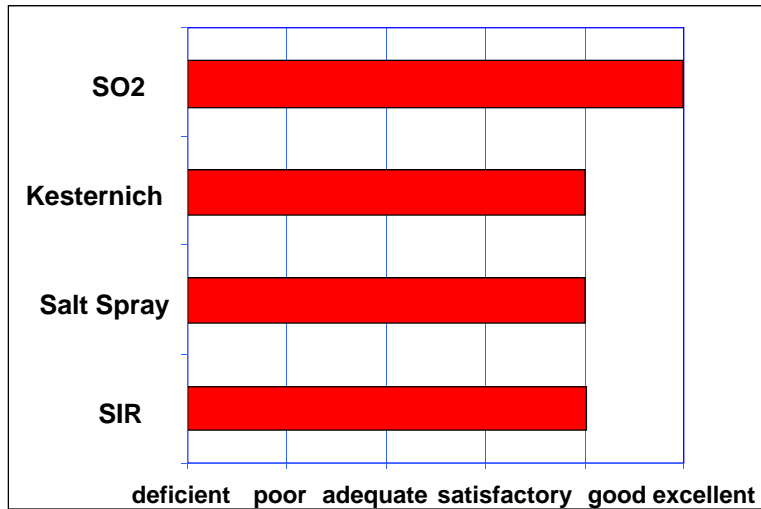

- ▶ Finishing with excellent corrosion resistance results.
- ▶ Most applicable for PCB's in the automotive, medical, military and electronics industry.
- ▶ Immersion tin is the surface finishing with the best corrosion test results in whole test series.

Industry used	<ul style="list-style-type: none"> ▶ Consumer industry ▶ Industry electronics (Backplanes) ▶ Automotive industry
Main assembly application	<ul style="list-style-type: none"> ▶ Eutectic and Lead free soldering ▶ Press fit applications
Main features	<ul style="list-style-type: none"> ▶ High corrosion resistance ▶ Good planarity for surface mount device applications ▶ High mechanical soldering point stability ▶ Suitable for horizontal plating

- ▶ Mixed Flowing Gas Test
 - No significant corrosion products were observed after 40 days MFG*
- ▶ Most commonly used surface finishing in the automotive industry
- ▶ “[Immersion tin] provides a cost-effective and yield-enhancing planar alternative to Nickel-Gold, HASL and OSPs.”**
- ▶ “It can be seen as a direct replacement to HASL from its performance and is cost competitive versus HASL.”***

No creep corrosion on ImSn
surface after 20 days MFG –
Test

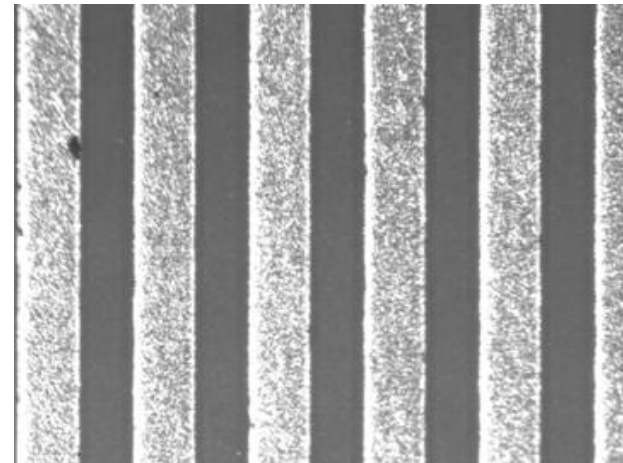

*C. Xu, K. Demirkan, G. Derkits: “Corrosion Resistance of PWB Final Finishes”, Alcatel – Lucent

** David H. Ormerod: “Immersion tin as a high performance solderable finish for fine pitch PWBs”; Article in Circuit World, 2000

*** K. Johal, H.J. Schreier: “Novel Immersion Tin Finish for Multiple Soldering of Surface Mount Packages” published on IPC 2000

Corrosion Resistance Mechanism of Immersion Tin

Three mechanisms are important to explain the corrosion resistance of Immersion Tin:

1) Passivation*

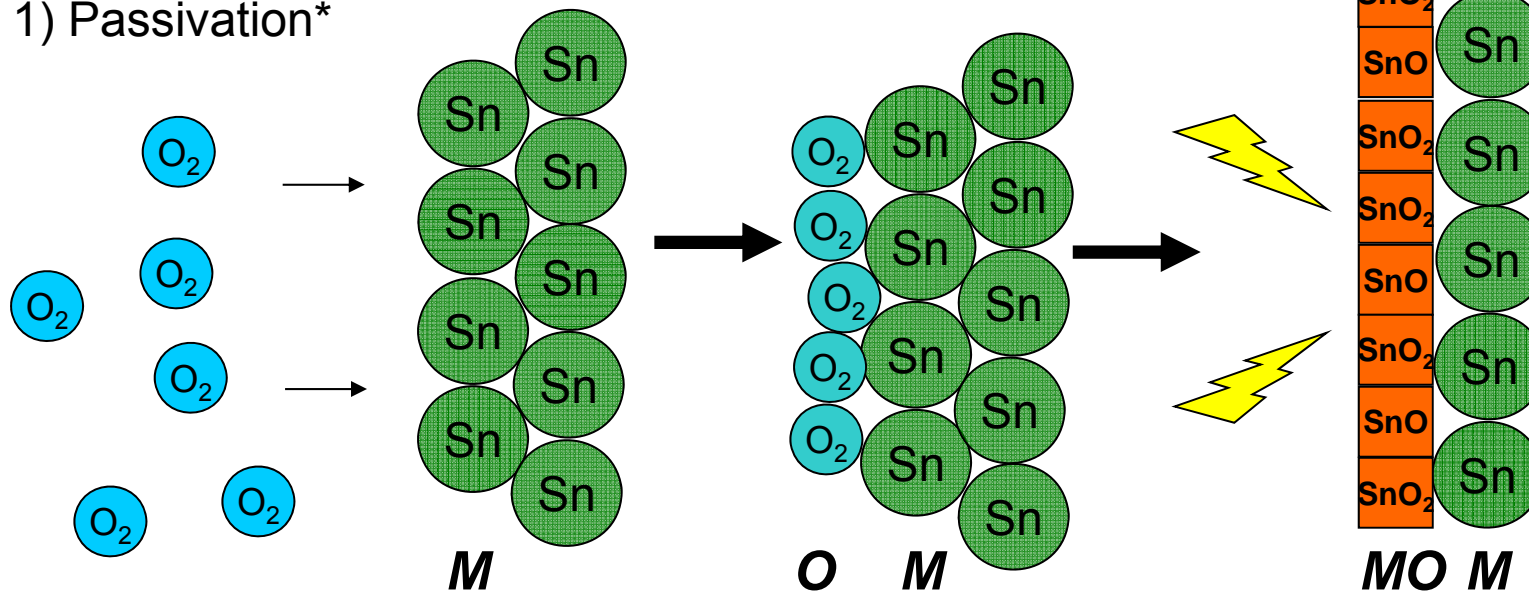

The thin free of pores oxide layer (SnO/SnO_2) adds Immersion tin a high corrosion resistance.

2) Hydrogen overvoltage*

- Partly inhibition of the hydrogen formation reaction in a humid environment → high hydrogen overvoltage

3) The good corrosion resistance of Cu/Sn Intermetallics (Bronze)

* Dr. P. Keller: "Elektrochemische und oberflächenanalytische Untersuchungen zur anodischen Dickschichtbildung auf Zinn und Kupfer/ Zinn – Legierungen", Dissertation

Corrosion Resistance Mechanism of Immersion Tin

3) The good corrosion resistance of Cu/Sn Intermetallics (Bronze)

Bronze Culture 2200 BC – 1000 BC



Iron Culture 1100 BC – 450 BC



3) The good corrosion resistance of Cu/Sn Intermetallics (Bronze)

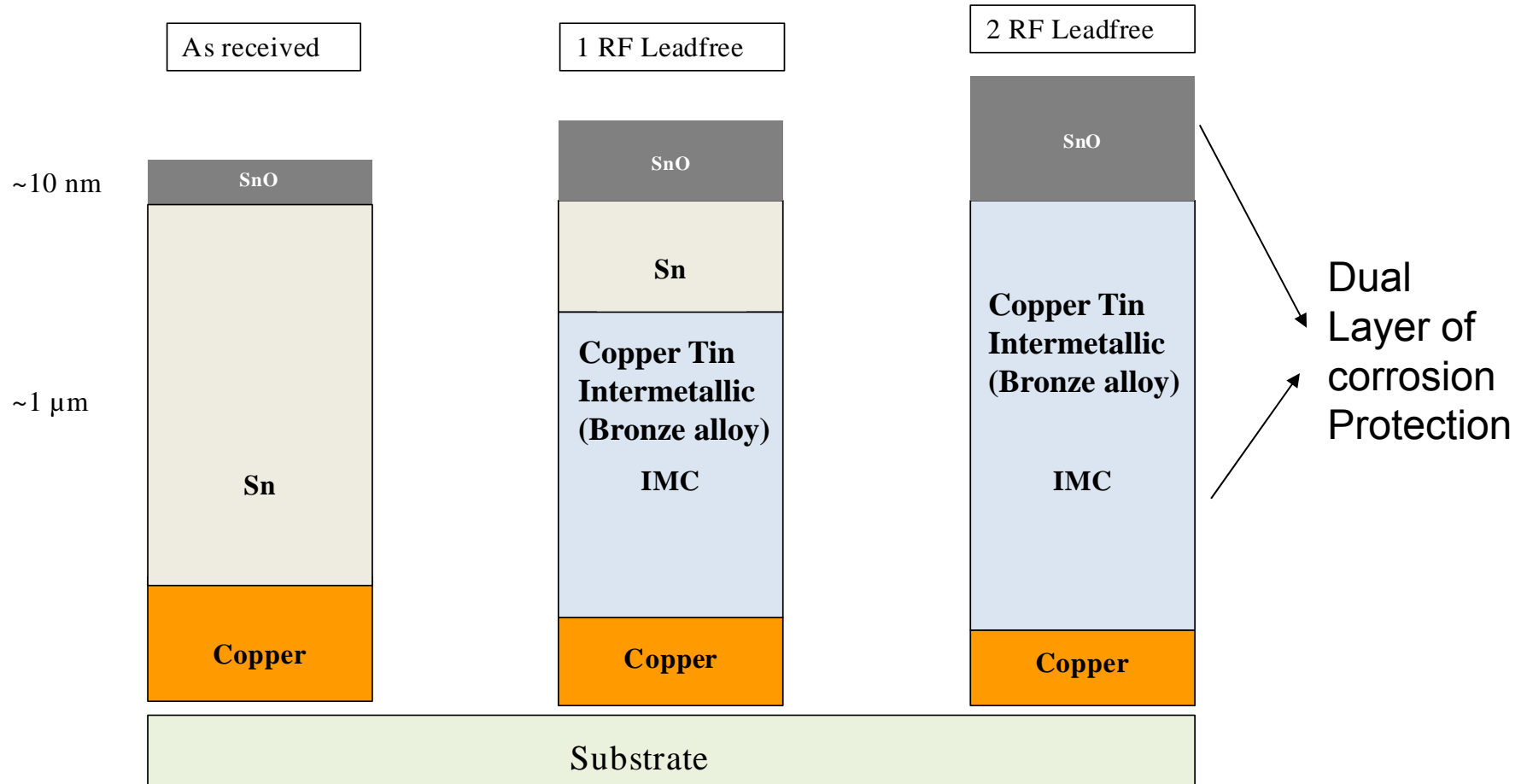



- ▶ Organic finishing with satisfactory corrosion resistance.
- ▶ If the OSP surface is damaged, the corrosion protection breaks down. Also after 1st reflow the corrosion protection of OSP is not there anymore.
- ▶ Additional corrosion protection recommended

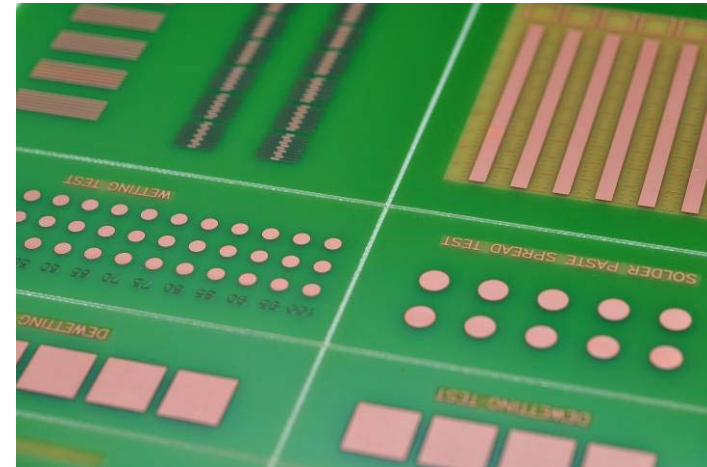

Industry used	<ul style="list-style-type: none"> ▶ Electronic industry ▶ Mobile phone industry ▶ Automotive electronic industry
Main assembly application	<ul style="list-style-type: none"> ▶ Soldering of CSPs / μBGAs
Main features	<ul style="list-style-type: none"> ▶ High planar surface ▶ Good solder joint reliability ▶ Relatively low-cost deposit ▶ Suitable for horizontal application ▶ High whisker resistance

* Article "Creep Corrosion on Lead Free PCBs in high sulfur environments" published in SMTA Int'l Proceedings, Orlando Florida, Oct. 2007

► Mild Clay Test

- Simulated a very harsh sulfur environment
- Slight creep corrosion after 6 days*

► Mixed Flowing Gas Test

- After 2 and 5 days varying degrees of corrosion was observed
- No creep corrosion or fiber- assisted electrochemical migration during the test period**

Creep corrosion on OSP surface*

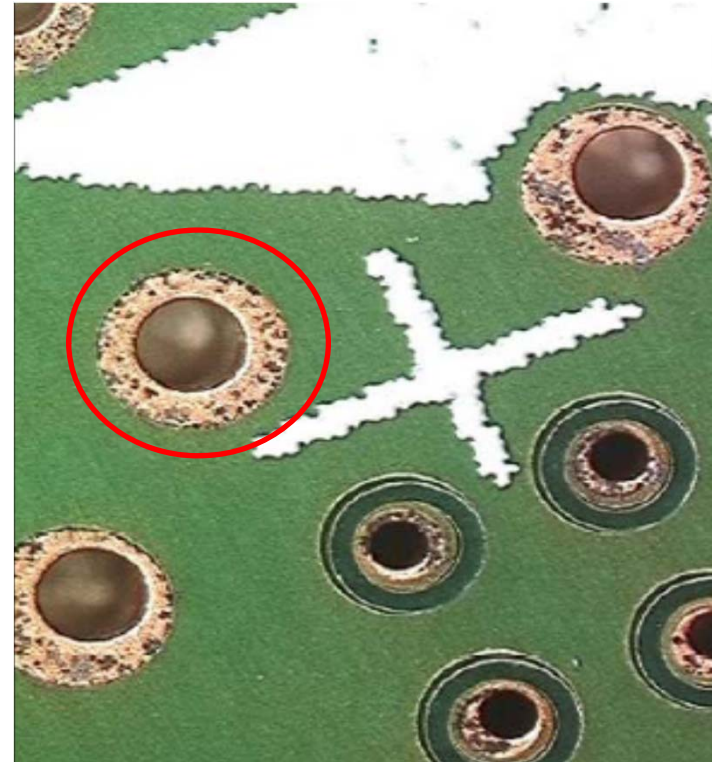

* Article SMTA: "Creep Corrosion on Lead Free PCBs in high sulfur environments", Orlando Florida, Oct. 2007

** C. Xu, K. Demirkan, G. Derkits: "Corrosion Resistance of PWB Final Finishes", Alcatel - Lucent



Summary



Corrosion resistance

Summary of Results

excellent

good

satisfactory

adequate

poor

deficient

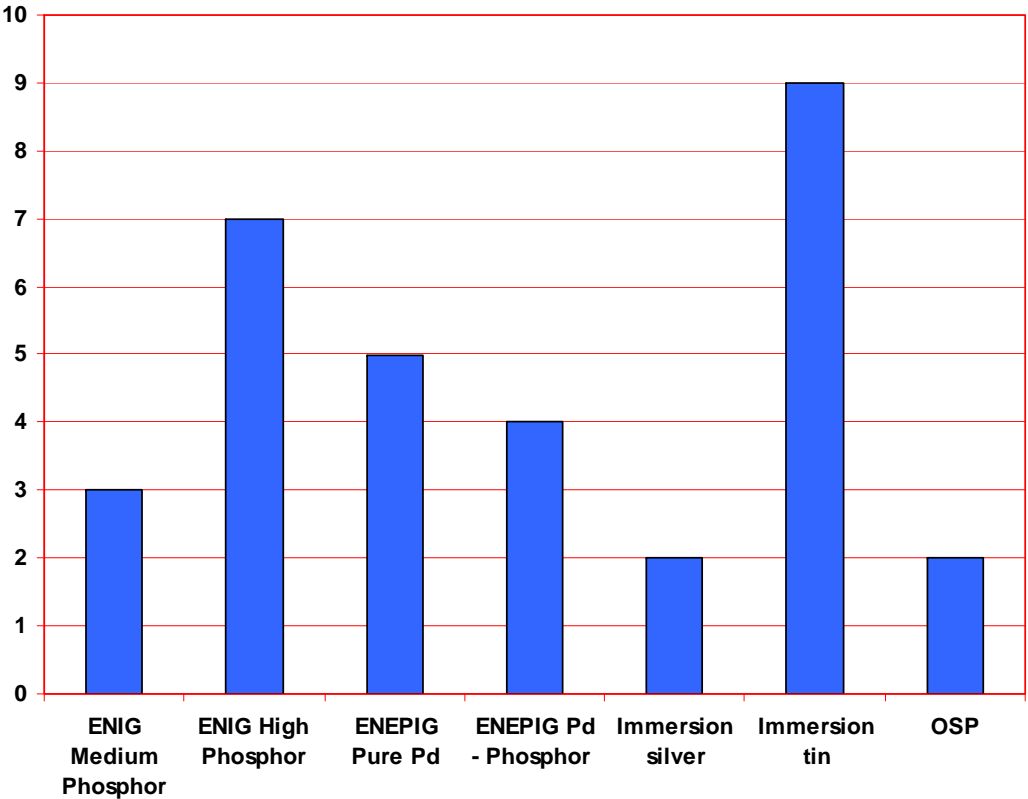

Immersion Tin, ENIG High Phosphor, and ENEPIG shows the best corrosion resistance for the final product.



Many thanks for your attention!

Questions?