

# Study of Various PCBA Surface Finishes

Georgie Thein, David Geiger, and Murad Kurwa

Flextronics International

Milpitas, California

## Abstract

In this study various printed circuit board surface finishes were evaluated, including: organic solderability preservative (OSP), plasma finish (PF), immersion silver (IAG), electroless nickel / immersion silver (ENIS), electroless nickel / immersion gold hi-phosphorus (ENIG Hi-P), and electroless nickel / electroless palladium / immersion gold (ENEPIG). To verify the performance of PF as a post-treatment option, it was added to IAG, ENIG Hi-P, and ENEPIG to compare with non-treated. A total of nine groups of PCB were evaluated. Each group contains 30 boards, with the exception on ENIS where only 8 boards were available.

The PCBs were subjected to various pre-conditioning to simulate different conditions of the surface finish. After pre-conditioning, the PCB was printed with lead-free SAC305 solder paste and SMT components placed. The PCB was reflowed using a typical reflow profile for a lead-free process.

After reflow, each surface finish under various pre-conditioning was rated for solder spread on pad, voiding performance of BGA and QFN devices, followed with cross sectional analysis. The results were tabulated by each pre-conditioning group and a summary table was provided. A summary was provided to rate each surface finish for use under three conditions: 1) fresh condition, 2) three times reflow, 3) storage simulation.

## Introduction

Various printed circuit board surface finishes are in use today for lead-free process. Each has its own advantages and disadvantages. These surface finishes include lead-free hot air solder leveling (HASL), organic solderability preservative (OSP), electroless nickel / immersion gold (ENIG), electrolytic Ni/Au, immersion silver (IAG), and immersion tin (ISn). Within these surface finishes, OSP, ENIG, and IAG are more popular.

Lead-free HASL is not readily available and difficult to have a consistent flatness. Electrolytic Ni/Au has high cost and if too much gold is deposited on pad, can lead to brittle solder joints. Immersion tin has solderability degradation after exposure to multiple heat cycles, as in a top and bottom side PCBA reflow process.

This study evaluated some additional available surface finishes. Electroless nickel / immersion silver (ENIS) intends to replace the gold in ENIG with silver to lower the cost. Electroless nickel / immersion gold with high phosphorus (Hi-P ENIG) intends to provide the highest resistance against corrosive environments.<sup>1</sup> Electroless nickel / electroless palladium / immersion gold (ENEPIG) provides excellent solderability for tin-copper-silver based solder alloy.<sup>2</sup> A polymer based coating (PF) that uses the plasma process to deposit was also evaluated.

In addition to ENIS, ENIG Hi-P, ENEPIG, and PF surface finish, OSP and IAG were also evaluated. A total of nine groups of surface finish were evaluated.

## Pre-Conditioning on PCB

The PCB with various surface finishes were subject to various pre-conditioning, to study the effect of each pre-conditioning in regards to solder spread and voiding performance on BGA and QFN devices.

Pre-conditioning #1: No pre-conditioning, assembly is reflowed in air. This is used as baseline.

Pre-conditioning #2: PCB pre-baked in an oven with temperature of 105°C for eight hours.

Pre-conditioning #3: PCB pre-baked in an oven with temperature of 155°C for six hours. This is to simulate one and a half (1.5) years of shelf life.

Pre-conditioning #4: PCB pre-baked in an oven with temperature of 72°C and 85% relative humidity for eight hours, followed with a bake at 105°C for one hour. This is to simulate more than six months shelf life.

Pre-conditioning #5: PCB goes through reflow oven one time, then assembled.

Pre-conditioning #6: PCB goes through reflow oven two times, then assembled.

Pre-conditioning #7: PCB goes through reflow oven three times, then assembled.

Pre-conditioning #8: Solder paste printed onto PCB, then the solder paste is cleaned off the PCB. This pre-conditioning holds the PCB for 24 hours before being assembled.

Pre-conditioning #9: Same as #8, except the PCB is hold for 48 hours before being assembled.

Pre-conditioning #10: Same as #8, except the PCB is hold for 72 hours before being assembled.

A total of nine different surface finishes were used. The first six consisted of OSP, PF, ENIS, IA<sub>g</sub>, ENEPIG, and Hi-P ENIG. Each surface finish has 3 samples per pre-conditioning, except ENIS, where only 1 sample was available for pre-conditioning #1 to #8. In addition to the first six, PF was added as a topcoat to IA<sub>g</sub>, ENEPIG, and Hi-P ENIG to observe if any difference in performance.

### Test Vehicle and Assembly Process

The test vehicle in use was the company Multifunction Test Vehicle (MFTV), as shown in figure 1.

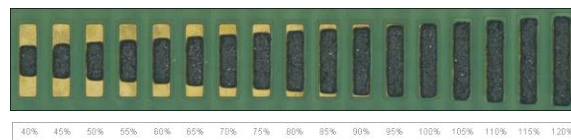

**Figure 1 – Multifunction Test Vehicle**

Solder paste used was no-clean lead-free Sn-3Ag-0.5Cu (SAC305) and the board was reflowed in convection oven with air atmosphere using a typical lead-free reflow profile.

### Solder Spread Test

Solder paste stencil opening was 1:1 to the board pad, except for the area where the solder spread test was used. For the solder spread test, the stencil opening was incremented from 40% to 120% of pad in 5% increments, as shown in figure 2. This is on an 80 mils by 20 mils non-solder mask defined pad.



**Figure 2 – Solder Spread Test Coupon before Reflow**

After reflow, each board was visually inspected to identify which pad had the least amount of solder paste coverage that achieved complete wetting. A sample is shown in figure 3, where 55% solder paste coverage had complete wetting.

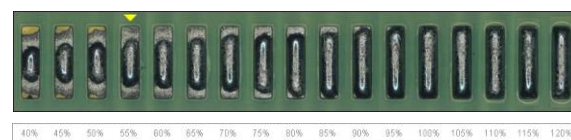

**Figure 3 – Solder Spread Test Coupon after Reflow**

Each test vehicle provides five locations for solder spread test, as shown in figure 4. As three samples (except ENIS, only 1 sample available per pre-conditioning) were used in each pre-conditioning scenario, a total of fifteen coupons were available for inspection from each surface finish.

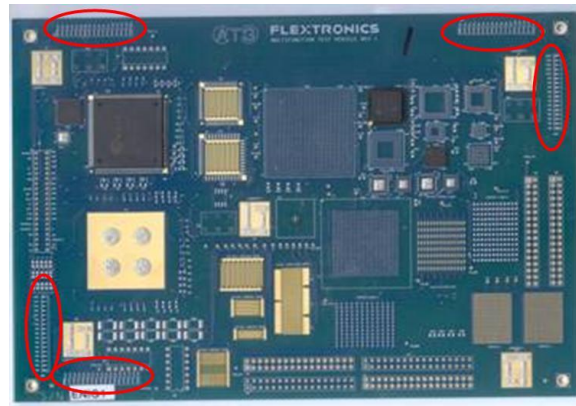

**Figure 4 – Locations of Solder Spread Test**

The results from each coupon were tabulated using statistical software, and a box plot graph generated for each pre-conditioning scenario. A sample box plot of pre-conditioning #1 (reflow in air) is shown in figure 5.

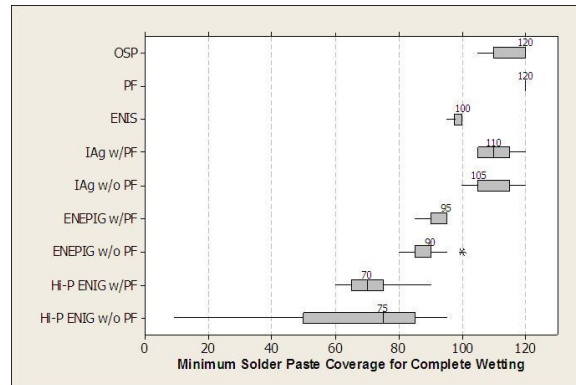

**Figure 5 – Box Plot of Solder Spread Test Result from Reflow in Air**

Based on the data, for reflow in air, Hi-P ENIG has the best spread with 70 to 75% solder paste coverage providing 100% wetting.

A summary of solder spread results is provided in Table 1.

**Table 1 – Solder Spread Test Results Summary**

PCB Surface Finish	Median Solder Paste Coverage for Complete Wetting							
	No Pre-conditioning	Baking	Aging 6 months	Aging 1.5 yrs	1x Reflow	2x Reflow	3x Reflow	Misprint
OSP	120%	100%	105%	105%	110%	110%	115%	105%
PF	120%	105%	105%	105%	110%	110%	120%	105%
ENIS	100%	100%	105%	100%	105%	105%	105%	95%
IAg w/PF	110%	105%	105%	115%	110%	110%	115%	105%
IAg w/o PF	105%	105%	110%	105%	110%	105%	110%	115%
ENEPIG w/PF	95%	95%	100%	95%	100%	100%	100%	95%
ENEPIG w/o PF	90%	95%	100%	85%	100%	95%	95%	95%
Hi-P ENIG w/PF	70%	60%	85%	85%	75%	75%	75%	80%
Hi-P ENIG w/o PF	75%	75%	105%	60%	75%	80%	70%	65%

The smaller the solder paste coverage required means better wetting performance. In general, Hi-P ENIG has the best wetting performance across all pre-conditioning scenarios. No significant difference was found between IAg, ENEPIG, and Hi-P ENIG surface finish alone and treated with PF. Both OSP and PF surface finishes required over-print of solder paste to achieve 100% wetting on pad.

**Voiding Performance of BGA and QFN**

The voiding percentage on BGA balls of a 196 I/O BGA (U1) and a 64 pin I/O BGA (U300) were measured using a laminography x-ray system. The locations of U1 and U300 are shown in figure 6.

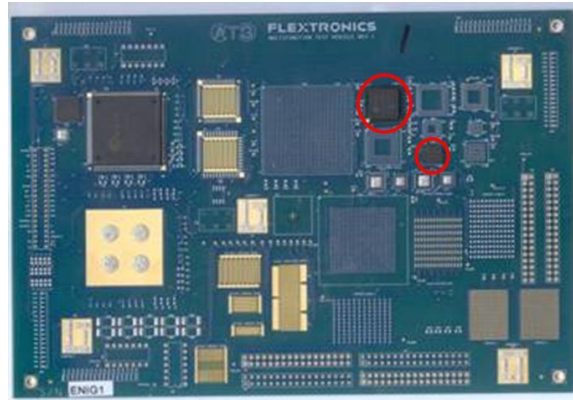

**Figure 6 – Locations of BGAs Measured for Voiding**

All voiding percentages were below the twenty-five percent allowable per the IPC-A-610 standard latest revision. Both ENEPIG and Hi-P ENIG had the least voiding at below four percent. All other surface finishes had voiding less than six percent. A box plot of the voiding percentage is shown in figure 7.

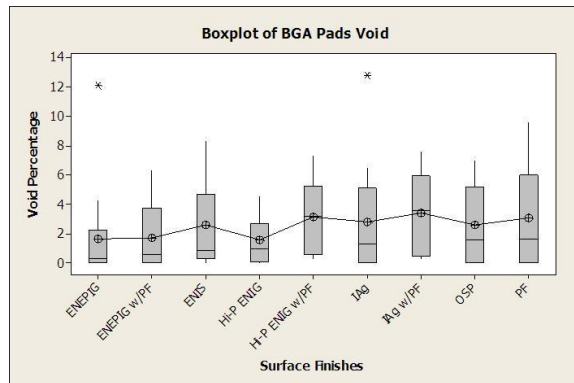

**Figure 7 – Box Plot of BGA Pads Voiding Percentage**

The voiding percentage on the ground pad of the QFN/BTC component at U314 was measured using the laminography x-ray system, and the results shown as box plots in figure 8.

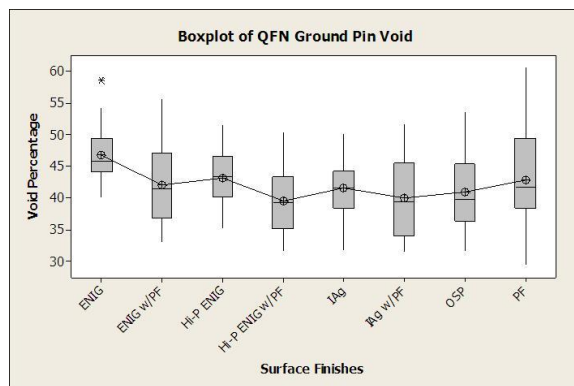
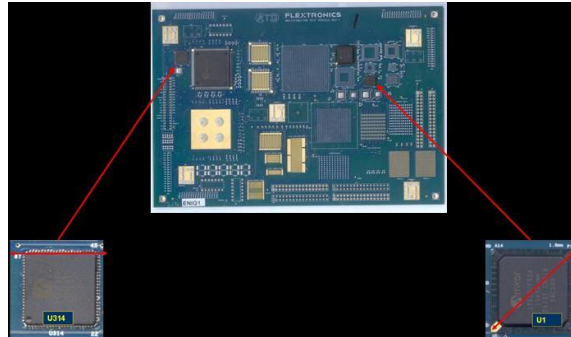

**Figure 8 – Box Plot of QFN Ground Pad Void**

The QFN ground pad voiding percentage varies from 35% to 50%. There was no particular surface finish with significantly less voiding.

**Cross-Sectioning**

One board from pre-conditioning #1, #4, and #7 from each surface finish had cross-sectioning performed on the QFN/BTC at U314 and BGA at U1. This was to inspect for any abnormal behavior at the interface between component pad to ball, and ball to PCB pad. Figure 9 showed the location of the QFN/BTC and BGA being cross-sectioned, and where the cut on the component was made.



**Figure 9 – Location of QFN/BTC and BGA Cross-Sectioned**

There was no significant difference noticed in the cross-section results between IAg, Hi-P ENIG, and ENEPIG surface finish with or without PF. Micro-voiding was noticed on the ball to pad interface for BGA on PF surface finish. This micro-voiding was not found on OSP or other surface finishes, see figure 10.

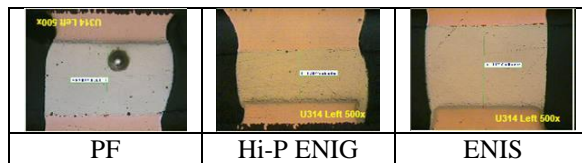

**Figure 10 – Picture of Micro-Voiding on PF versus Hi-P ENIG and ENIS**

During cross-sectioning, the stand-off height of BGA at U1 and QFN/BTC at U314 were measured. The results were plotted in figure 11.



**Figure 11 – Graph of Stand-Off Height on BGA and QFN/BTC**

The stand-off height on the BGA at U1 varies between 0.25 to 0.35mm. Measurement between the left corner, center, and right corner of the BGA shows little variation. The stand-off height on the QFN/BTC varies between 0.06 to 0.14mm. More variations were observed on the measurement between left corner, center, and right corner of the QFN/BTC package.

**Summary**

New board surface finishes evaluated for this study were Plasma Finish (PF), Electroless Nickel / Immersion Silver (ENIS), Electroless Nickel / Immersion Gold Hi-Phosphorous (Hi-P ENIG), and Electroless Nickel / Electroless Palladium / Immersion Gold (ENEPIG).

Surface finishes with Organic Solderability Preservative (OSP) and Immersion Silver (IAg) were also tested. In addition, plasma finish was added as the top coat protection to IAg, Hi-P ENIG, and ENEPIG to verify any performance differences.

A total of nine groups of PCB surface finish were evaluated. PCBs were subject to various pre-conditioning prior to assembly to simulate possible scenarios during typical assembly processes (for example: reflowed in air, baking, misprint, etc). Other pre-conditioning simulated storage and shelf life, and more pre-conditioning simulated extreme processes (1x, 2x, 3x reflow prior to assembly). In total, each group of PCB surface finishes had 30 pieces available with 3 samples per pre-conditioning, except for ENIS where only 8 pieces were available.

Based on the results from the solder spread test, there was no significant improvement observed on the surface finish with OSP versus PF, or the surface finish with PF added as a top coat protection.

On surface finishes with PF, copper discoloration was observed (figure 12) visually and micro voiding at the pad interface was found on cross-sectioning (figure 10).

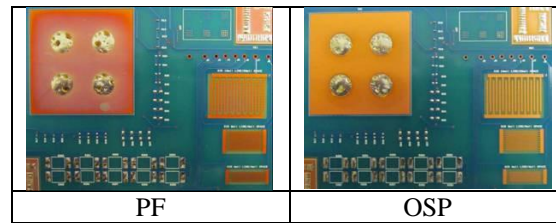

**Figure 12 – PF Discoloration Compared to OSP with no pre-conditioning**

With the results from this study, a rating is provided in Table 2. Hi-P ENIG performs best under fresh conditions, three times reflow, and storage simulation. For fresh conditions, ENEPIG, IAg, and ENIS had better performance than OSP and PF. For three times reflow, Hi-P ENIG, ENEPIG performs better than IAg, ENIS, and OSP, then followed by PF. For storage simulation, ENEPIG performs similarly to Hi-P ENIG, and both are better than IAg, ENIS, and OSP, then followed by PF.

**Table 2 - Rating**

	Fresh Conditions	Three Times Reflow	Storage Simulation
<b>Better</b> ↑	Hi-P ENIG	Hi-P ENIG	Hi-P ENIG
	ENEPIG	ENEPIG	ENEPIG
	IAg	IAg	IAg
	ENIS	ENIS	ENIS
	OSP	OSP	OSP
	PF	PF	PF

There are many other factors that will affect the selection of surface finishes for an assembly, such as cost, key pad contact, IMC strength for drop/shock/vibration, etc. The user should verify the product design requirement and select the proper surface finish for use.

**Reference**

1. Sven Lamprecht and Petra Backus, “High Phosphorus ENIG – highest resistance against corrosive environment”, Atotech.
2. Yukinori Oda, Masayuki Kiso, Seigo Kurosaka, Akira Okada, Kota Kitajima, and Shigeo Hashimoto, “Study of Suitable Palladium and Gold Thickness in ENEPIG Deposits, Uyemura.





# Study of Various PCBA Surface Finishes

Georgie Thein, David Geiger, and Murad Kurwa

Flextronics International

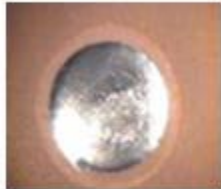
Milpitas, California

**Lead-free surface finishes must survive elevated temperatures and multiple heat cycles.**

PCB Surface Finish	Advantages	Disadvantages	Images
<b>Lead-free HASL</b>	Good solderability	Lack of consistency, flatness & availability	No image
<b>OSP (High Temp)</b>	Low cost, Flatness	Very limited solder spreading, Solderability degradation @ elevated temp & cycles, Non-conductive, ICT probe, ionic & press-fit concerns	
<b>ENIG</b>	Excellent solderability, Flatness, Al-wire bondability, Low contact resistance	"Black Pad" concern	
<b>Electrolytic Ni/Au</b>	Excellent Solderability, Flatness, Wire bondability, Low contact resistance	High cost, Au embrittlement if too thick, Layout constrains	
<b>Immersion Ag</b>	Excellent solderability, Flatness, Al-wire bondability, Low contact resistance	Tarnish (handling & storage), corrosion in high sulfur environment $\mu$ voiding concerns	
<b>Immersion Sn</b>	Flatness, Excellent solderability (when fresh)	Solderability degradation @ elevated temps & cycles	No image



**PCB Surface Finishes Evaluated**

<b>Surface Finish</b>	<b>Coating Thickness</b>
Organic Solderability Preservative (OSP)	0.39 – 0.51 $\mu\text{m}$
Immersion Silver (IAg)	0.226 – 0.231 $\mu\text{m}$
Electroless Ni / Immersion Silver (ENIS)	Supplier Spec
Electroless Nickel / Immersion Gold Hi-P (ENIG)	Ni: 4.30 – 4.83 $\mu\text{m}$ Au: 0.042 -- 0.08 $\mu\text{m}$
Electroless Nickel / Electroless Palladium / Immersion Gold (ENEPIG)	Ni: 3.936 – 4.089 $\mu\text{m}$ PD: 0.125 -- 0.158 $\mu\text{m}$ Au: 0.055 -- 0.074 $\mu\text{m}$
Plasma Finish (PF)	Supplier Spec

Test Description	Test Vehicle Description	Pre-conditioning Information	Total PCB Quantities per Surface Finish
<b>Reflow Process (Wettability, Spreading &amp; Voiding)</b>	<b>Flextronics Multifunction Test Vehicle, Rev 1 (Assembled)</b>	<ul style="list-style-type: none"> <li>• <b>No Pre-conditioning, Assembly reflowed in air (Baseline)</b></li> <li>• <b>Baking (8 hrs. at 105°C)</b></li> <li>• <b>Aging (6 hrs at 155°C, equivalent to 1.5 yrs. shelf life)</b></li> <li>• <b>Aging (8 hrs at 72°C &amp; 85% RH, followed by a bake at 105°C for 1 hr)</b></li> <li>• <b>Multiple Reflows (after 1x, 2x &amp; 3x reflows)</b></li> <li>• <b><i>Number of Misprints / Cleaning (1 Misprint / Wash cycle)</i></b></li> </ul>	<b>30 (10 conditions x 3 samples)</b>

# Solder Spread Test Results

## Flextronics Multifunction Test Vehicle (Rev 1)

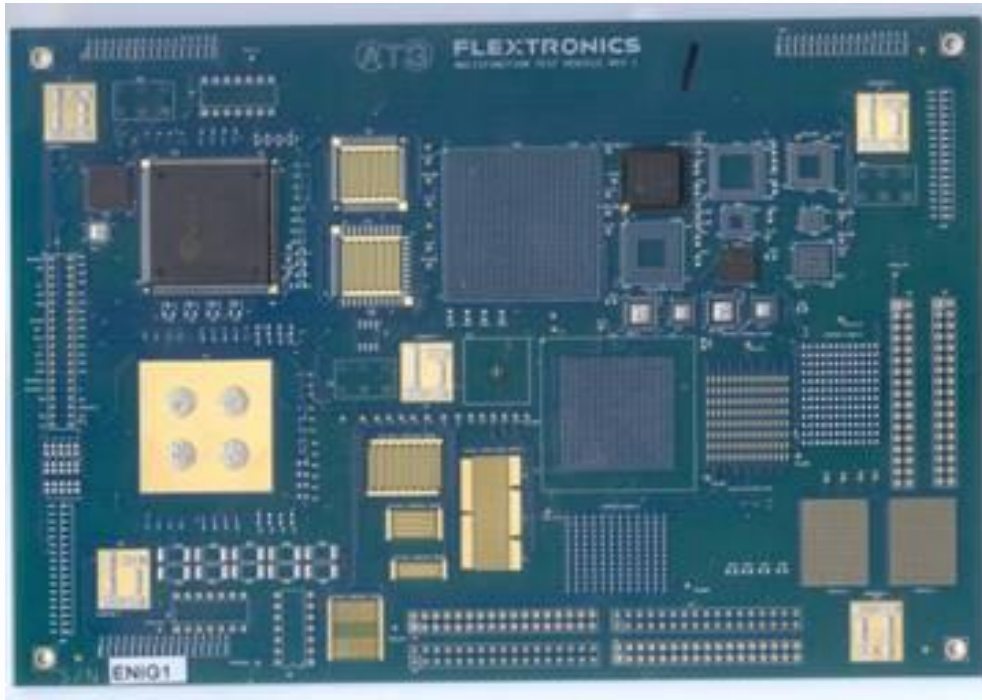

Component Description	Location	Quantities per PCB Surface Finish
<b>QFP208</b>	<b>U3</b>	<b>30</b>
<b>QQFN</b>	<b>U314</b>	<b>30</b>
<b>PBGA196</b>	<b>U1</b>	<b>30</b>
<b>CABGA64</b>	<b>U5</b>	<b>30</b>
<b>0201</b>	<b>R1 - R20</b>	<b>120</b>

- No clean lead-free SAC305 solder paste used
- Typical lead-free reflow profile used

## Solder Spread Test Details

- The amount of solder paste coverage was varied between 40% to 120% in 5% increments (on an 80 mils x 20 mils non-solder mask defined pad).
- After reflow, they were visually inspected to identify the pad with the least amount of solder paste coverage that had complete wetting. The inspection was performed at 235x magnification.
- 15 coupons were inspected for each surface finish and pre-conditioning combination tested.

**Solder Spread Test Coupon before Reflow (40% to 120% Solder Paste Coverage)**

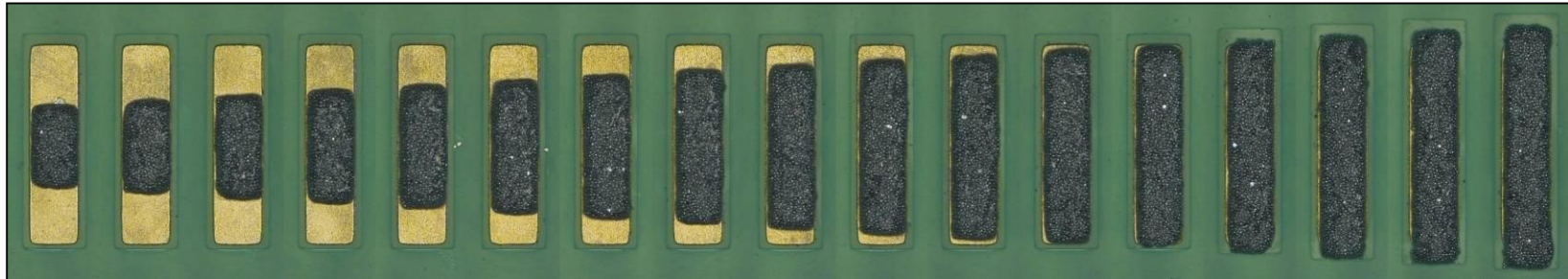

40% 45% 50% 55% 60% 65% 70% 75% 80% 85% 90% 95% 100% 105% 110% 115% 120%

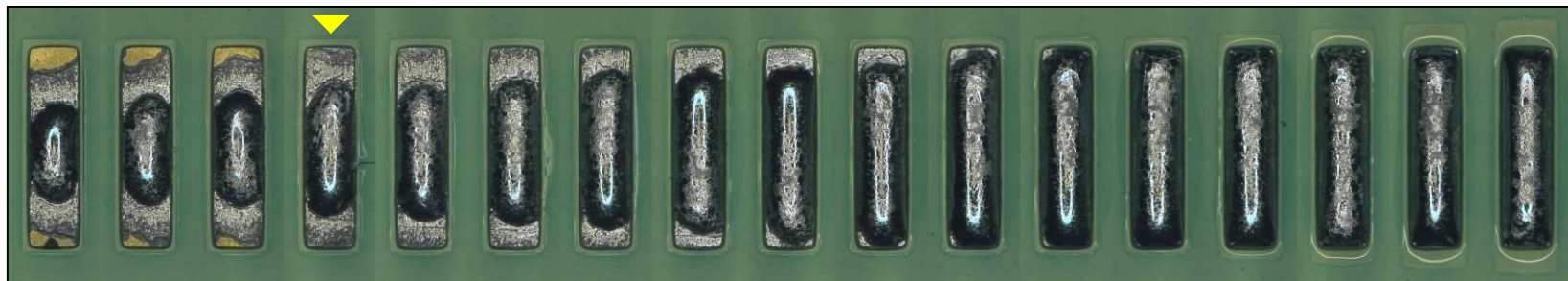

**Solder Spread Test Coupon after Reflow (Complete Wetting achieved with 55% Solder Paste Coverage in the above example)**

Locations of Solder Spread Test

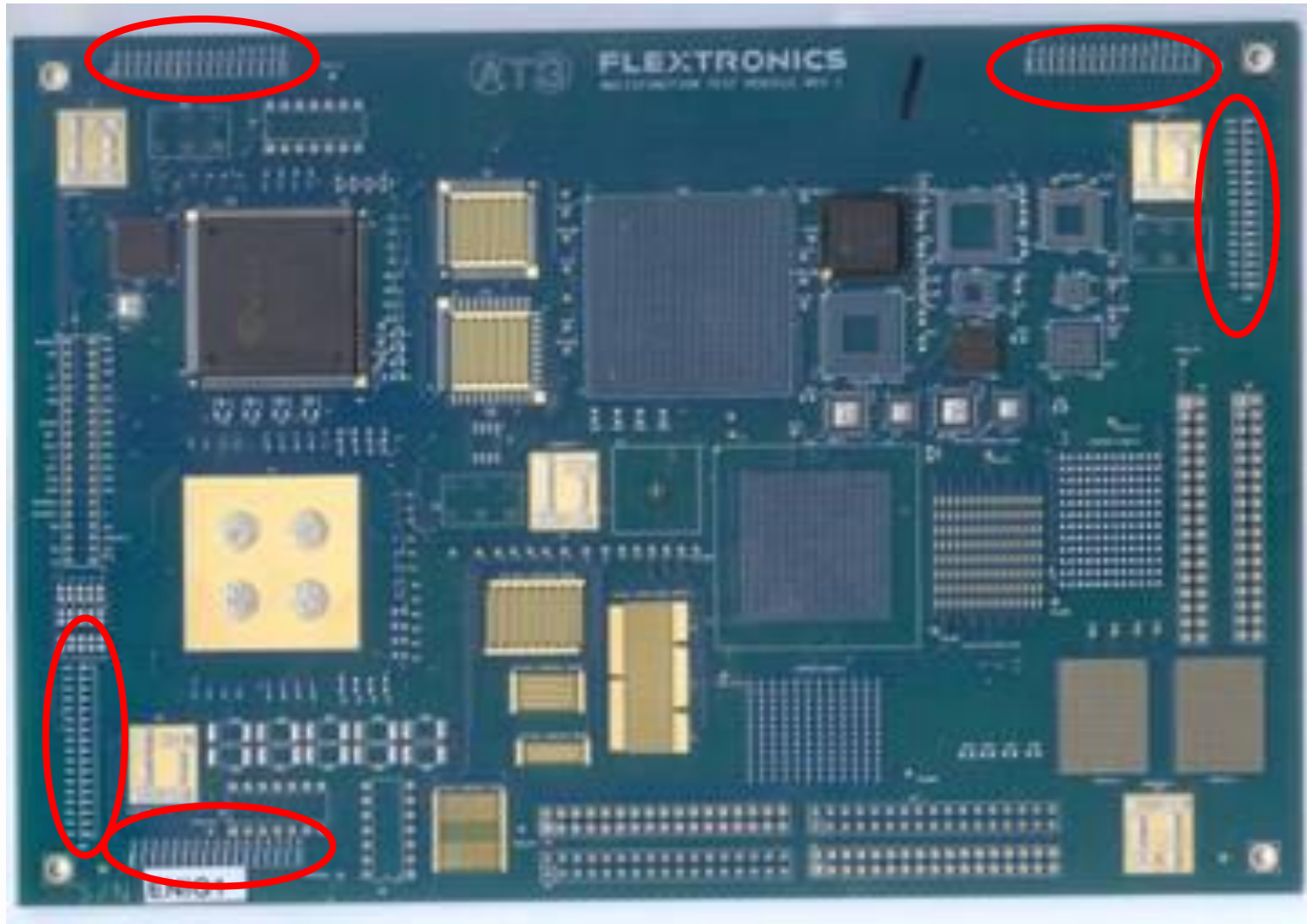

Baseline (No Pre-conditioning, Reflowed in Air)

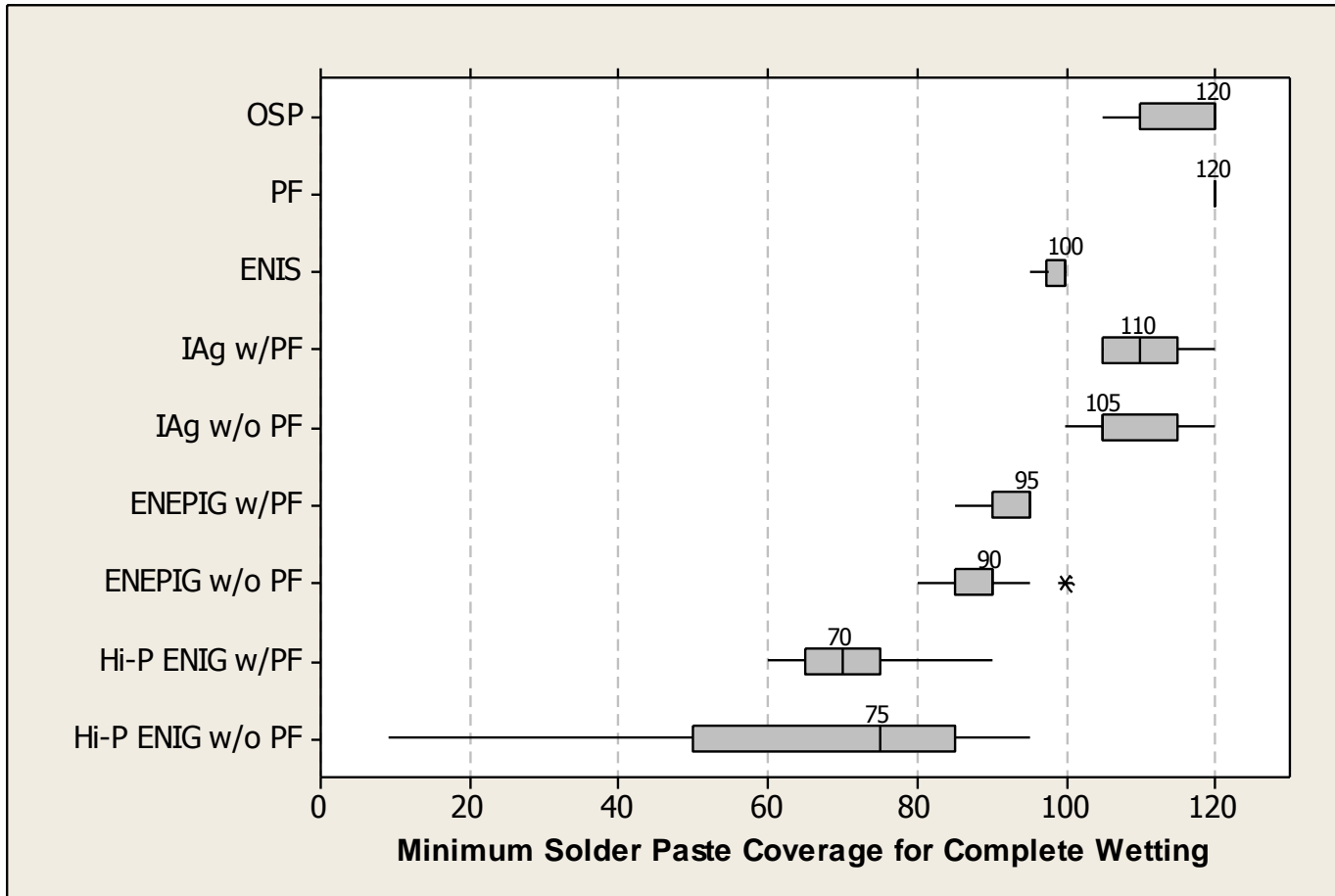

**Better** ←

Pre-Conditioning (Baking for 8 hrs. at 105°C)

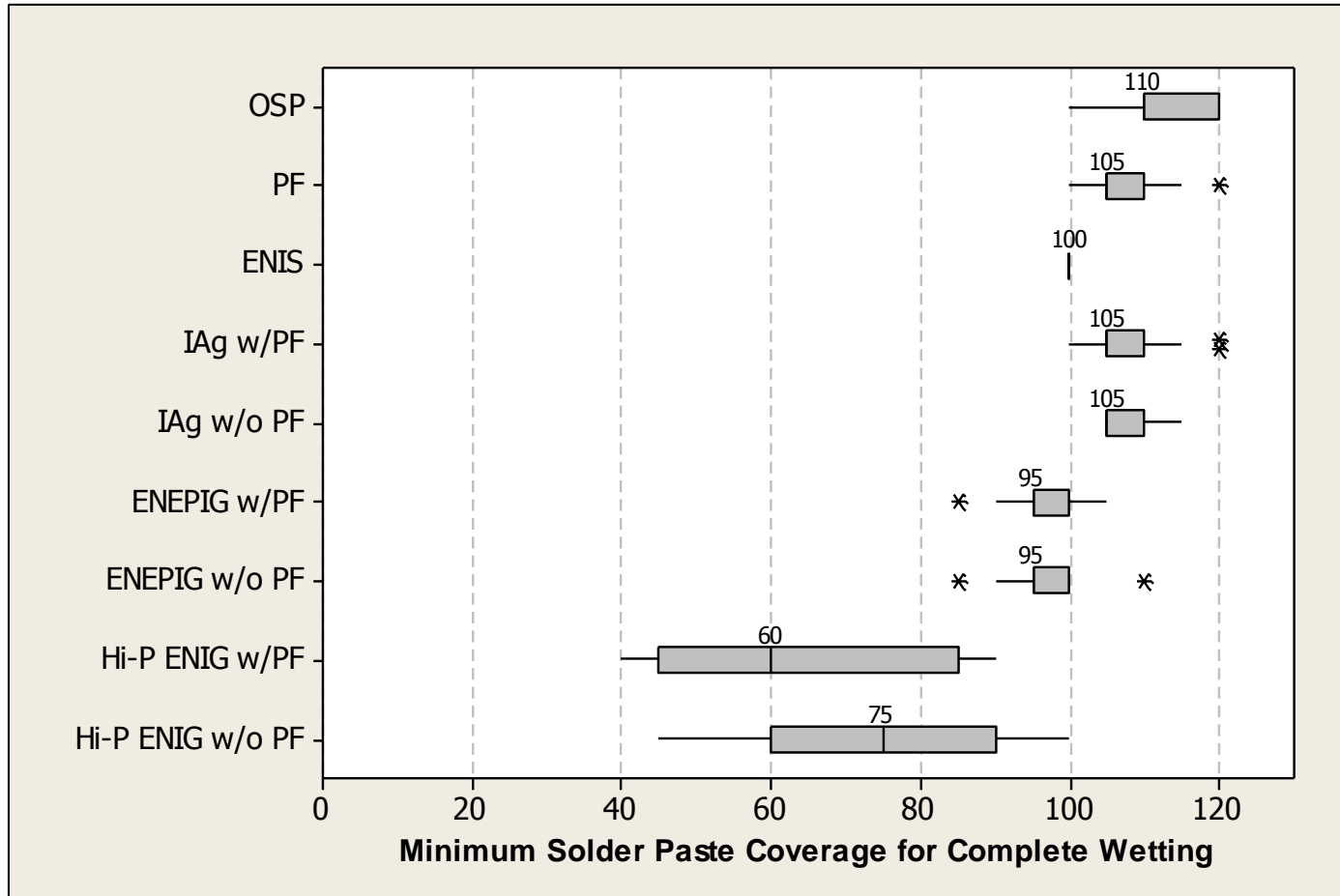

**Better** ←



Aging for 6 hrs. at 155°C (Equivalent to 1.5 years shelf life)

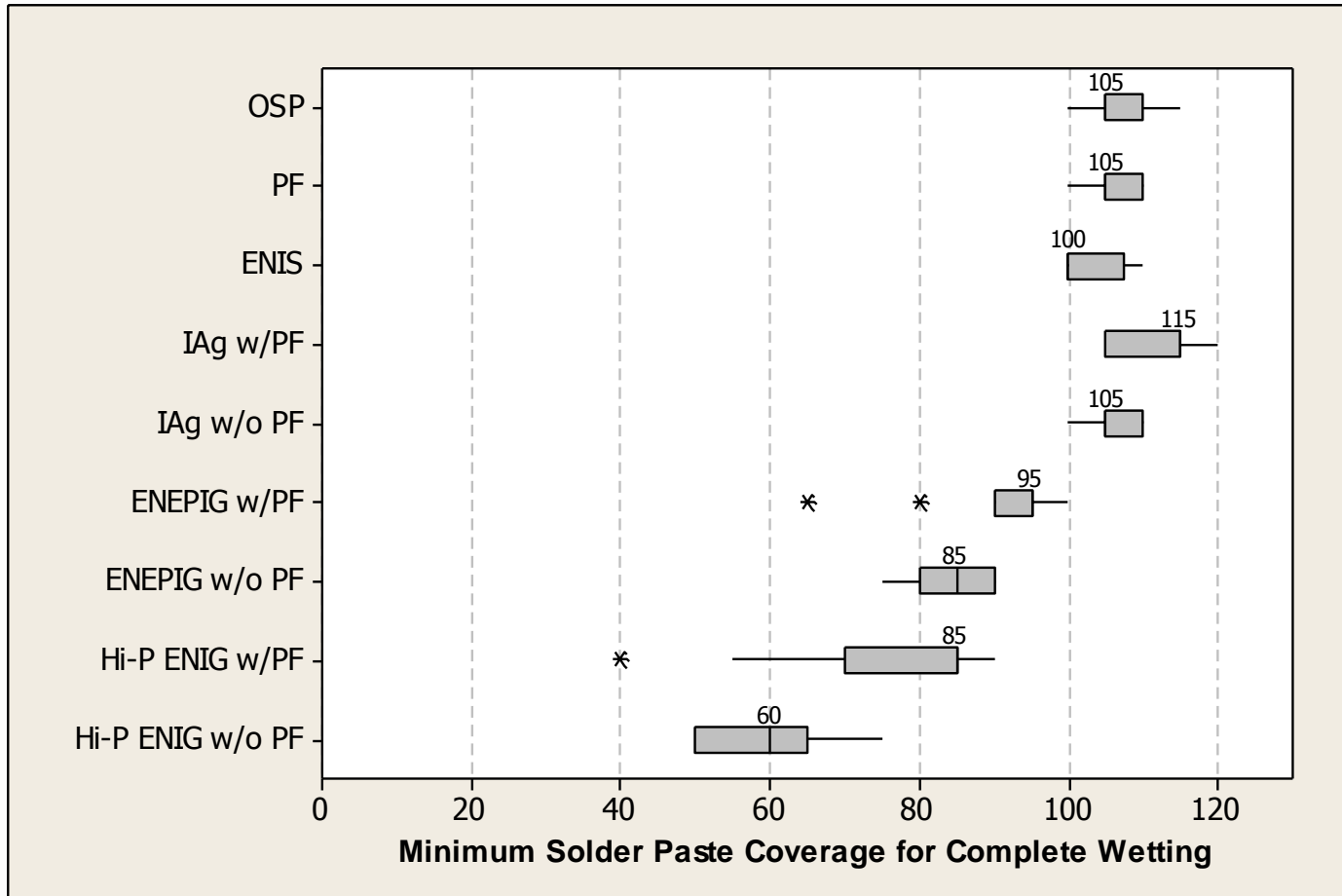

**Better** ←

Aging for 8 hrs at 72°C & 85% R.H. (> 6 months Shelf Life)

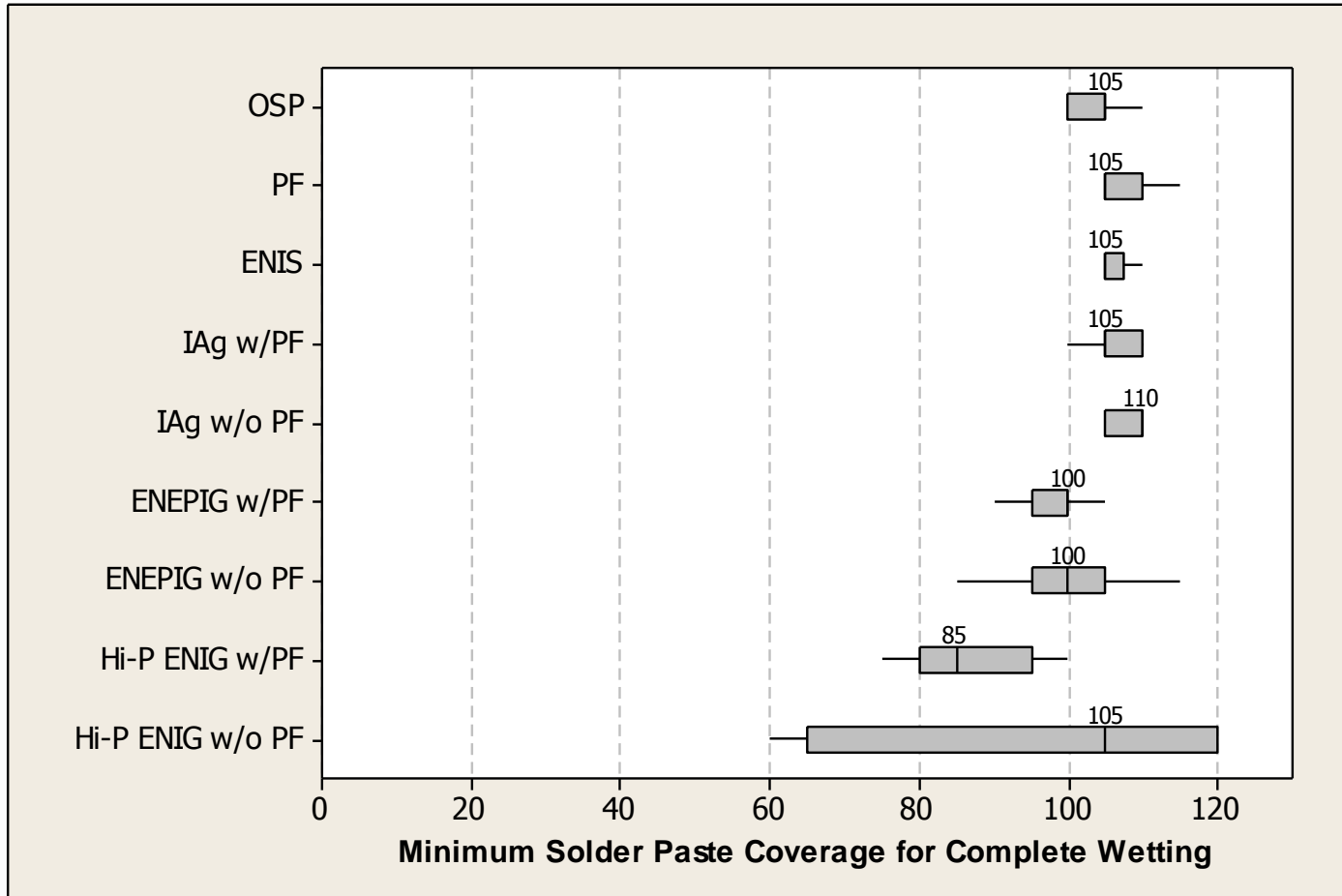

**Better** ←

Pre-Conditioning (1x reflows)

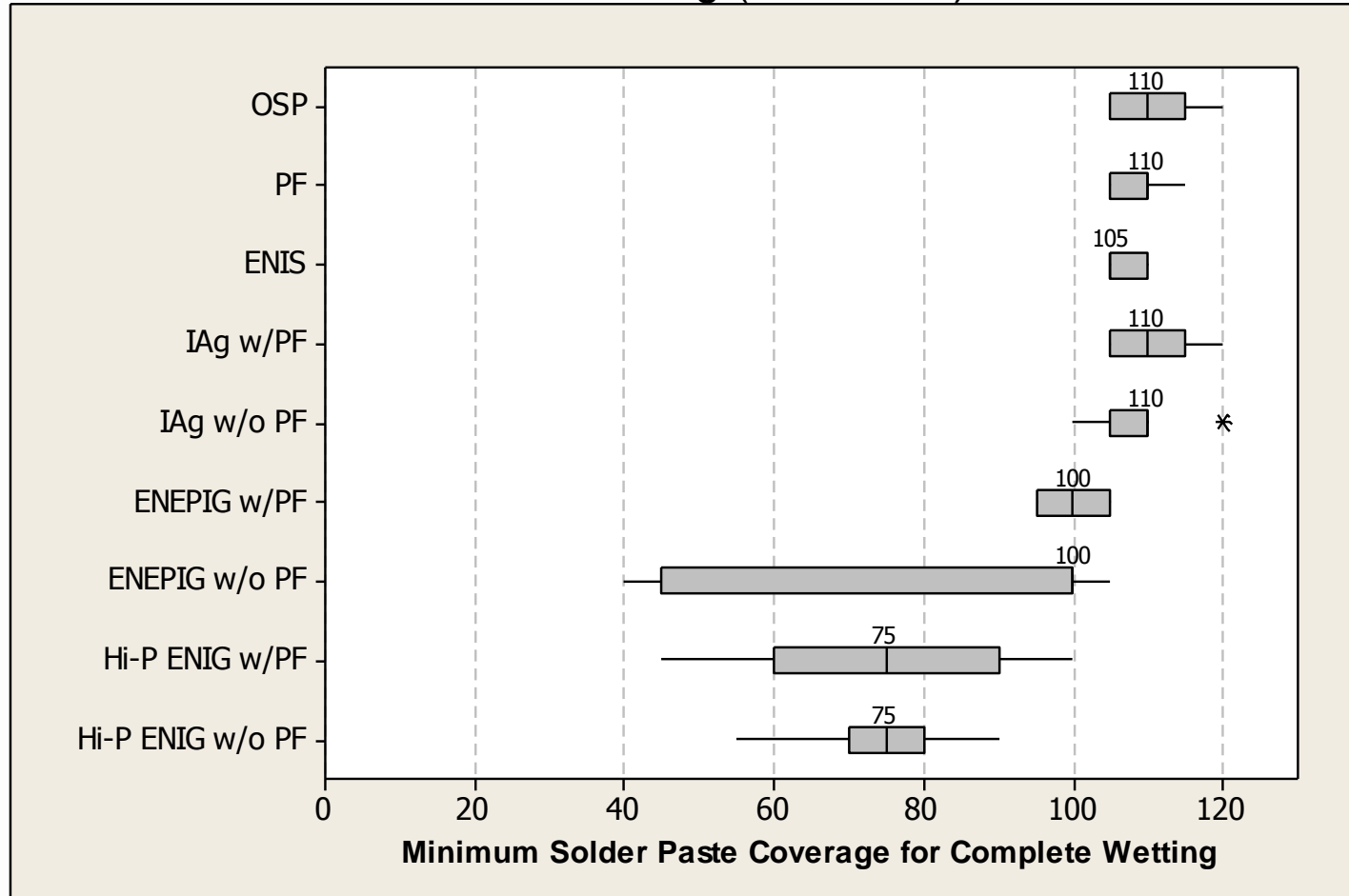

**Better** ←

Pre-Conditioning (2x reflows)

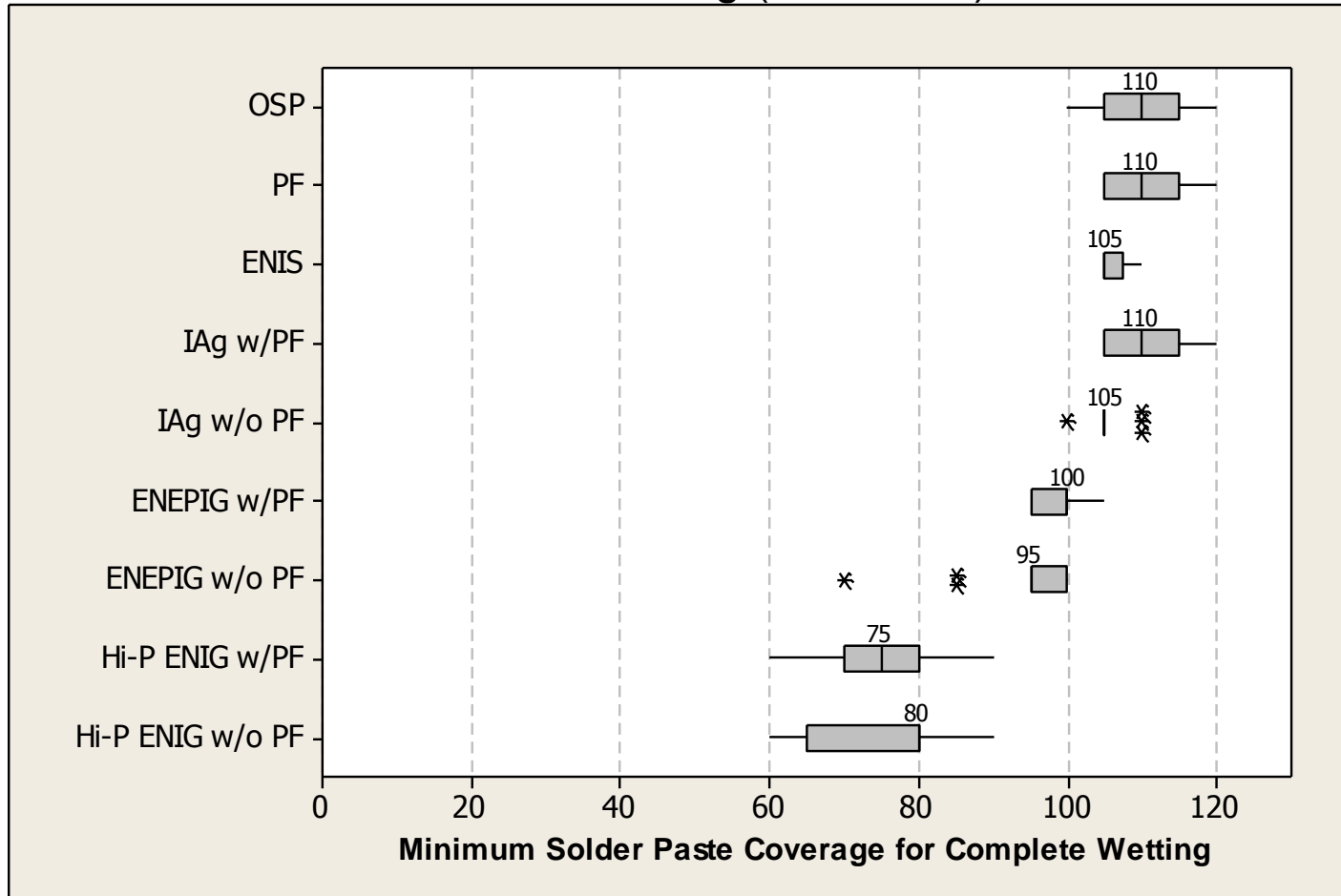

**Better** ←

Pre-Conditioning (3x reflows)

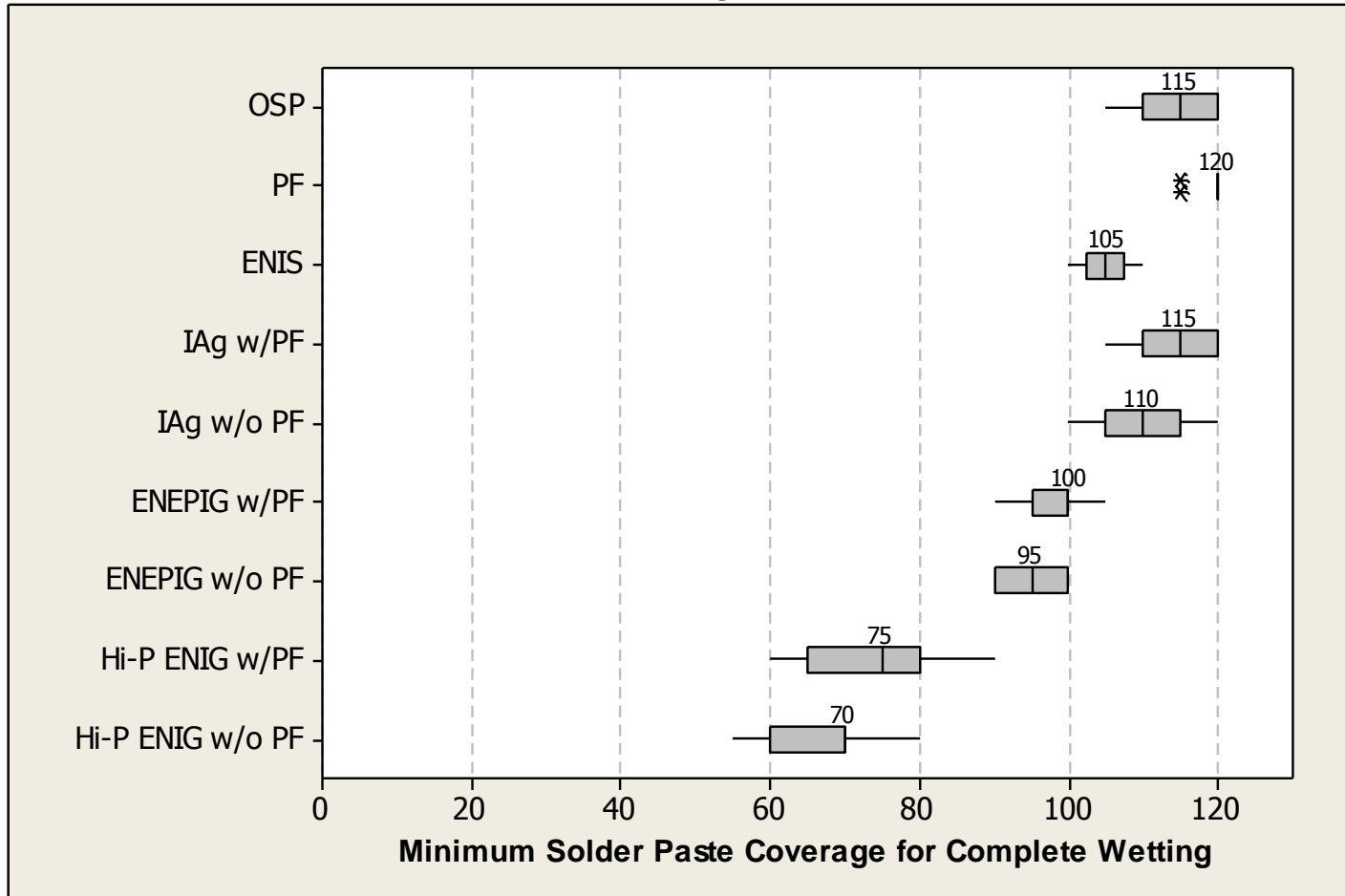

**Better** ←

Pre-Conditioning (1 Misprint Cycle - hold for 24 hours)

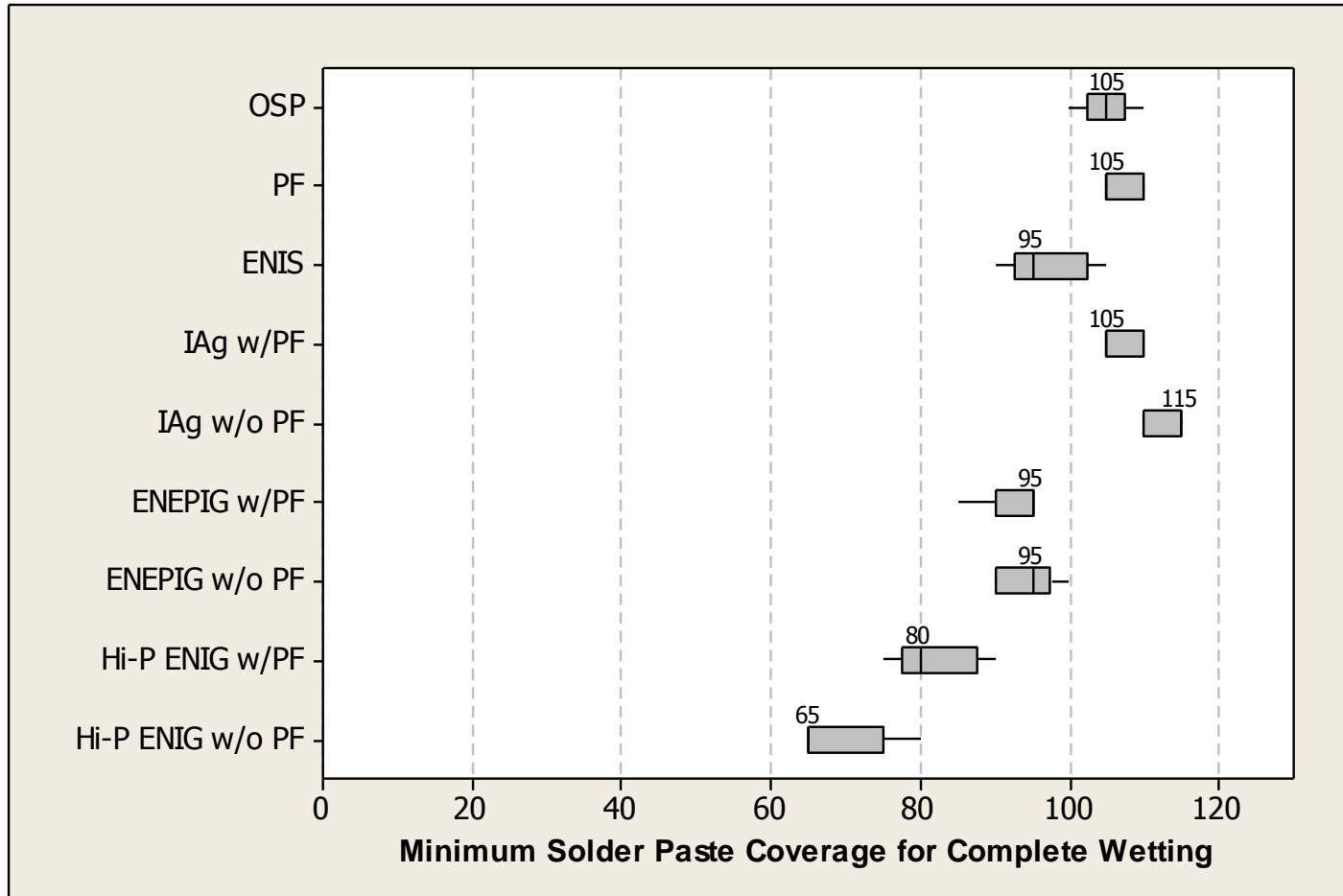

**Better** ←

## Sample Pictures of Solder Spread Test

Images from PCBs baked at 105°C for 8 hours. (Highlighted percentage indicate selection)

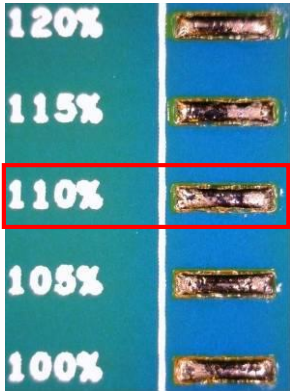

OSP

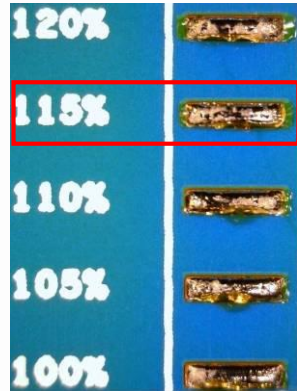

PF

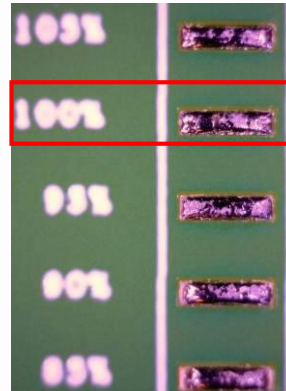

ENIG

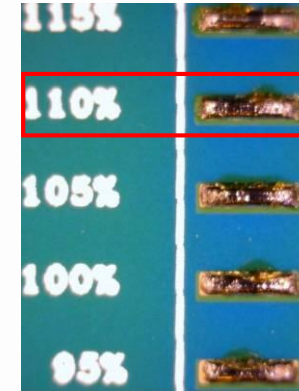

IAG w/ PF

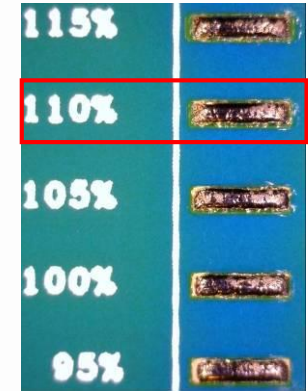

IAG w/o PF

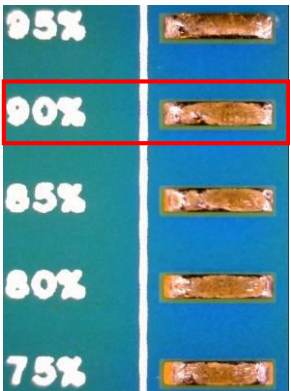

ENEPIG  
w/ PF

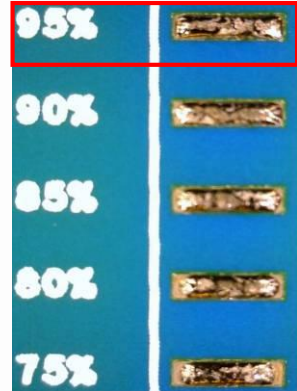

ENEPIG  
w/o PF

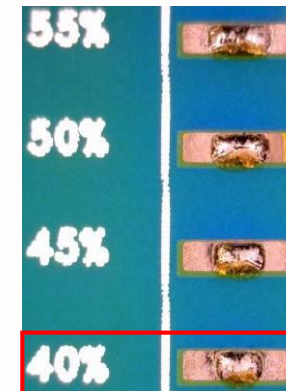

Hi-P ENIG  
w/ PF

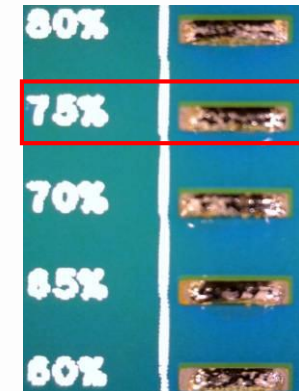

Hi-P ENIG  
w/o PF

## Solder Spread Test Results Summary

- When reflowed in Air without Pre-conditioning, Hi-P ENIG (High Phosphorous, Electroless Nickel / Immersion Gold) had the best spreading, followed by ENEPIG (Electroless Nickel / Electroless Palladium / Immersion Gold) and ENIS (Electroless Nickel / Immersion Silver).
- There was no significant impact in solder spreadability on aging simulation for 6 months and 1.5 years, and also reflow pre-conditioning.

PCB Surface Finish	Median Solder Paste Coverage for Complete Wetting							
	No Pre-conditioning	Baking	Aging 6 mos	Aging 1.5 yrs	1x Reflow	2x Reflow	3x Reflow	Misprint
OSP	120%	100%	105%	105%	110%	110%	115%	105%
PF	120%	105%	105%	105%	110%	110%	120%	105%
ENIS	100%	100%	105%	100%	105%	105%	105%	95%
IAG w/PF	110%	105%	105%	115%	110%	110%	115%	105%
IAG w/o PF	105%	105%	110%	105%	110%	105%	110%	115%
ENEPIG w/PF	95%	95%	100%	95%	100%	100%	100%	95%
ENEPIG w/o PF	90%	95%	100%	85%	100%	95%	95%	95%
Hi-P ENIG w/PF	70%	60%	85%	85%	75%	75%	75%	80%
Hi-P ENIG w/o PF	75%	75%	105%	60%	75%	80%	70%	65%



# Voiding Performance of BGA and QFN

## BGA Voiding Measurement

- The voiding percentage on BGA balls of U1 (196 pins BGA), and U300 (64 pins BGA) were measured using laminography x-ray system.

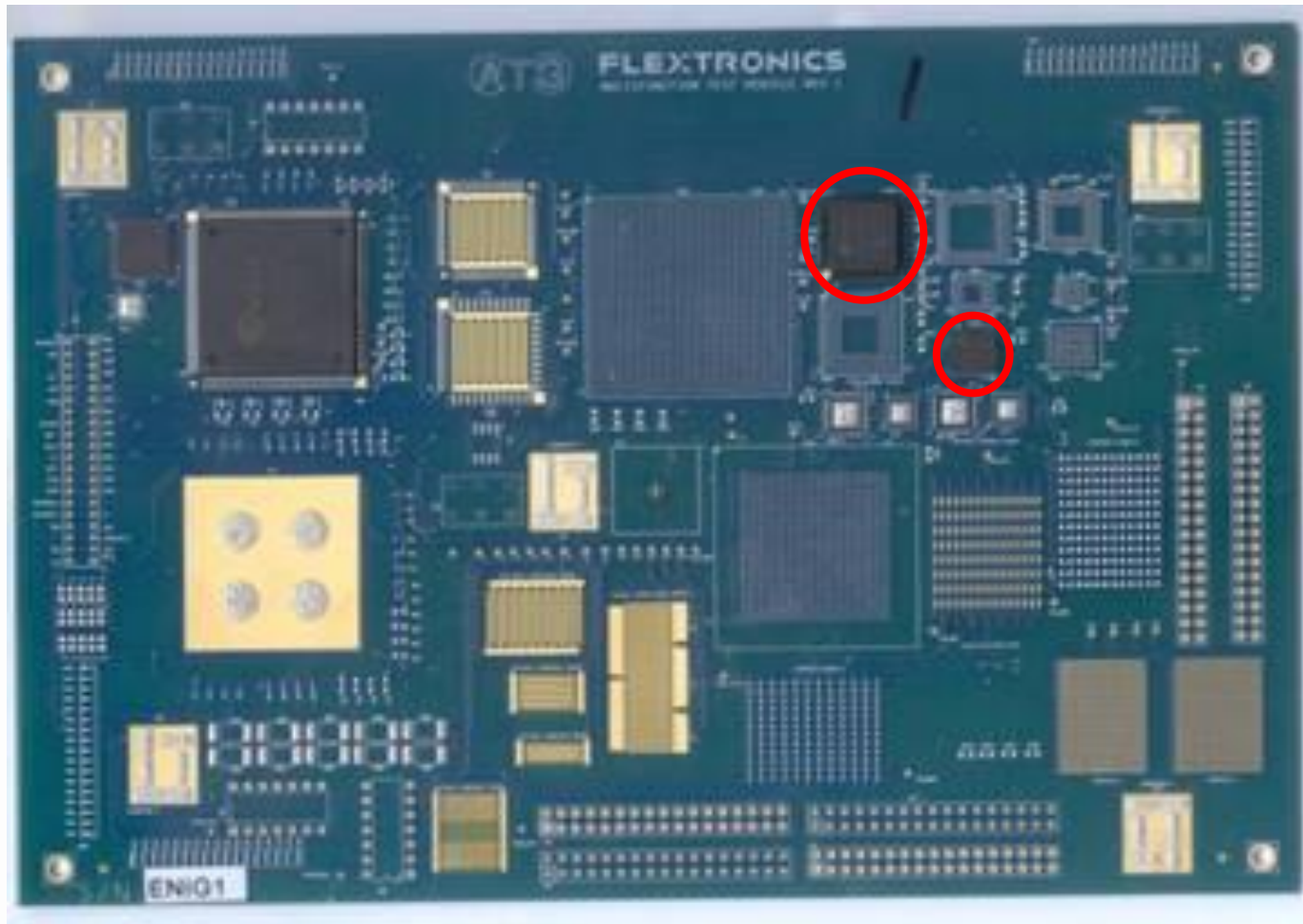

## BGA Voiding Measurement

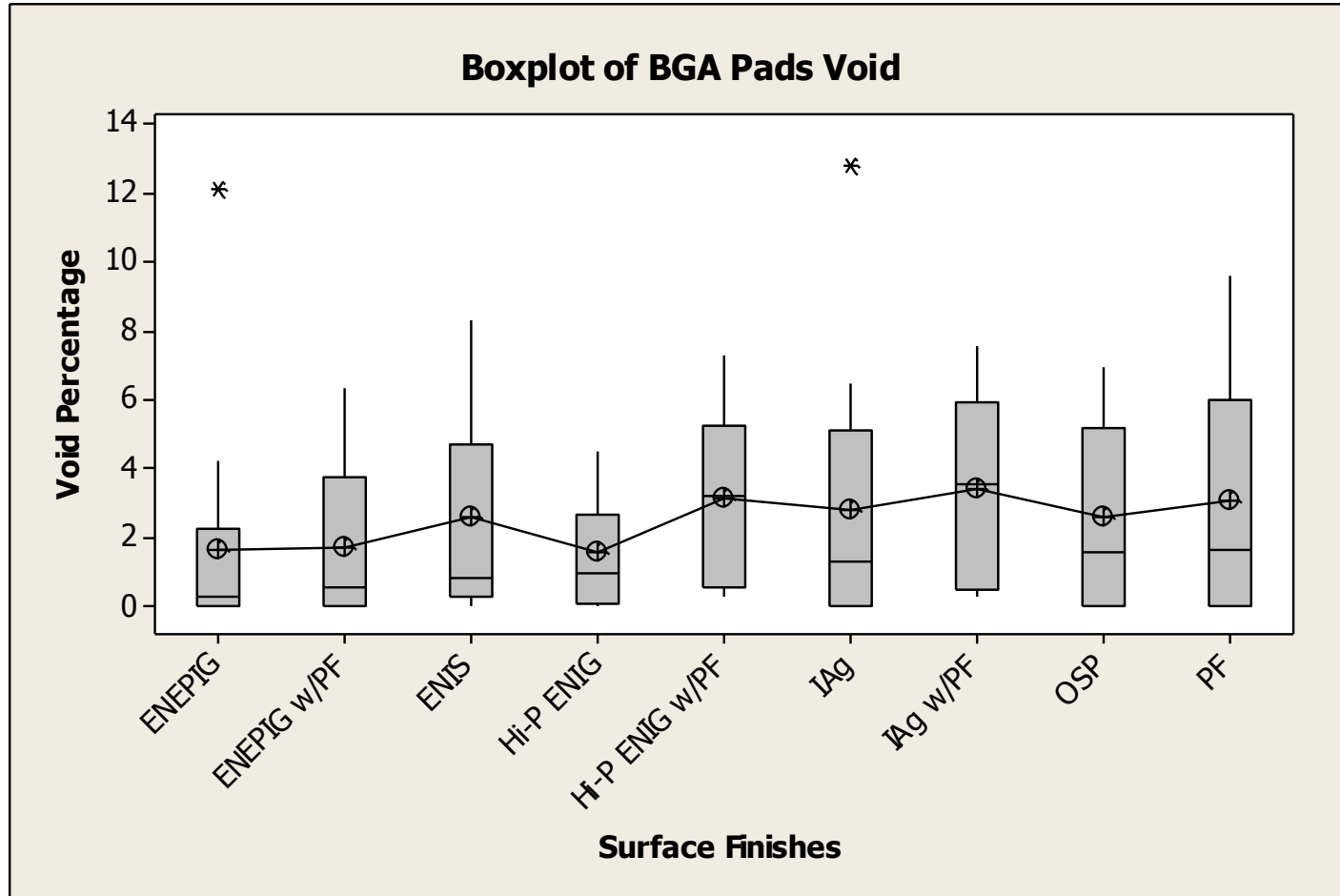

All voiding percentage at BGA ball to PCB interface were within the 25% allowable per IPC-A-610 revision E.

## QFN Ground Pad Voiding Measurement

- The voiding percentage on the ground pad of U314 (QFN) was measured using laminography x-ray system.

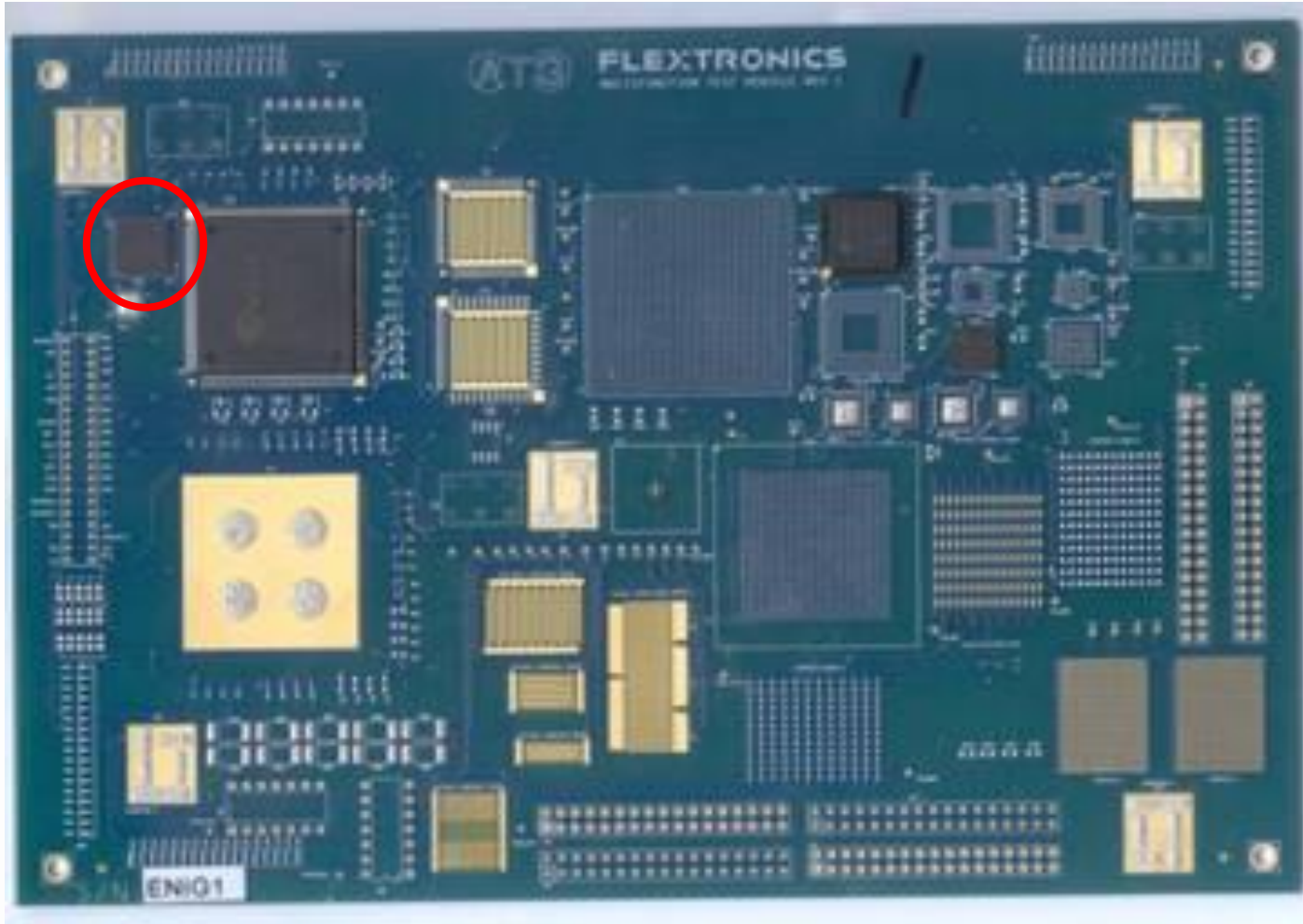

## QFN Ground Pad Voiding Measurement

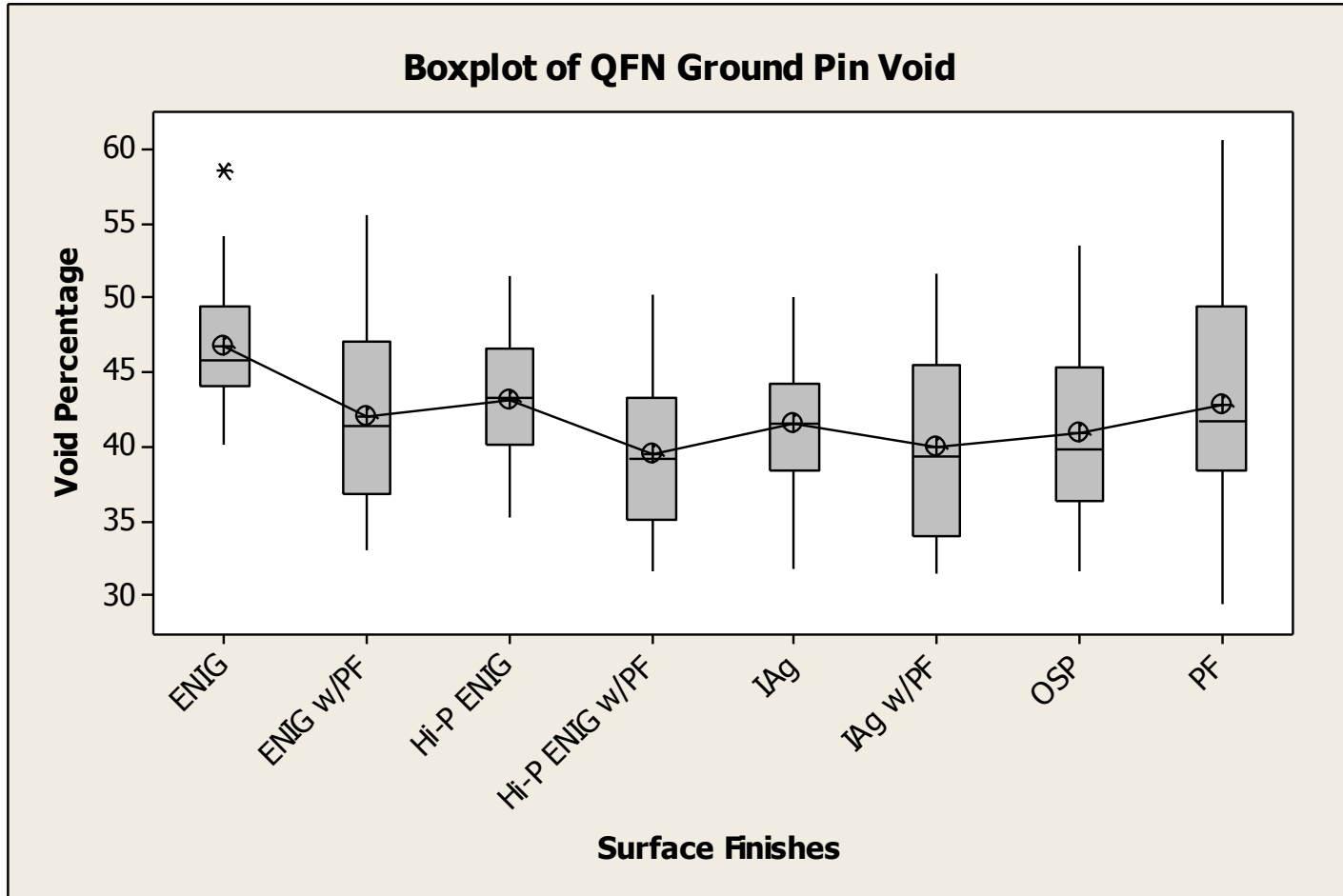

The voiding percentage were consistent throughout various conditions.

# Cross-Sectioning

- One board from no pre-conditioning, 3X reflow, and Aging for 8 hrs at 72°C & 85% R.H. (> 6 months Shelf Life) had U314 (QFN) and U1 (196 pins BGA) cross-sectioned.

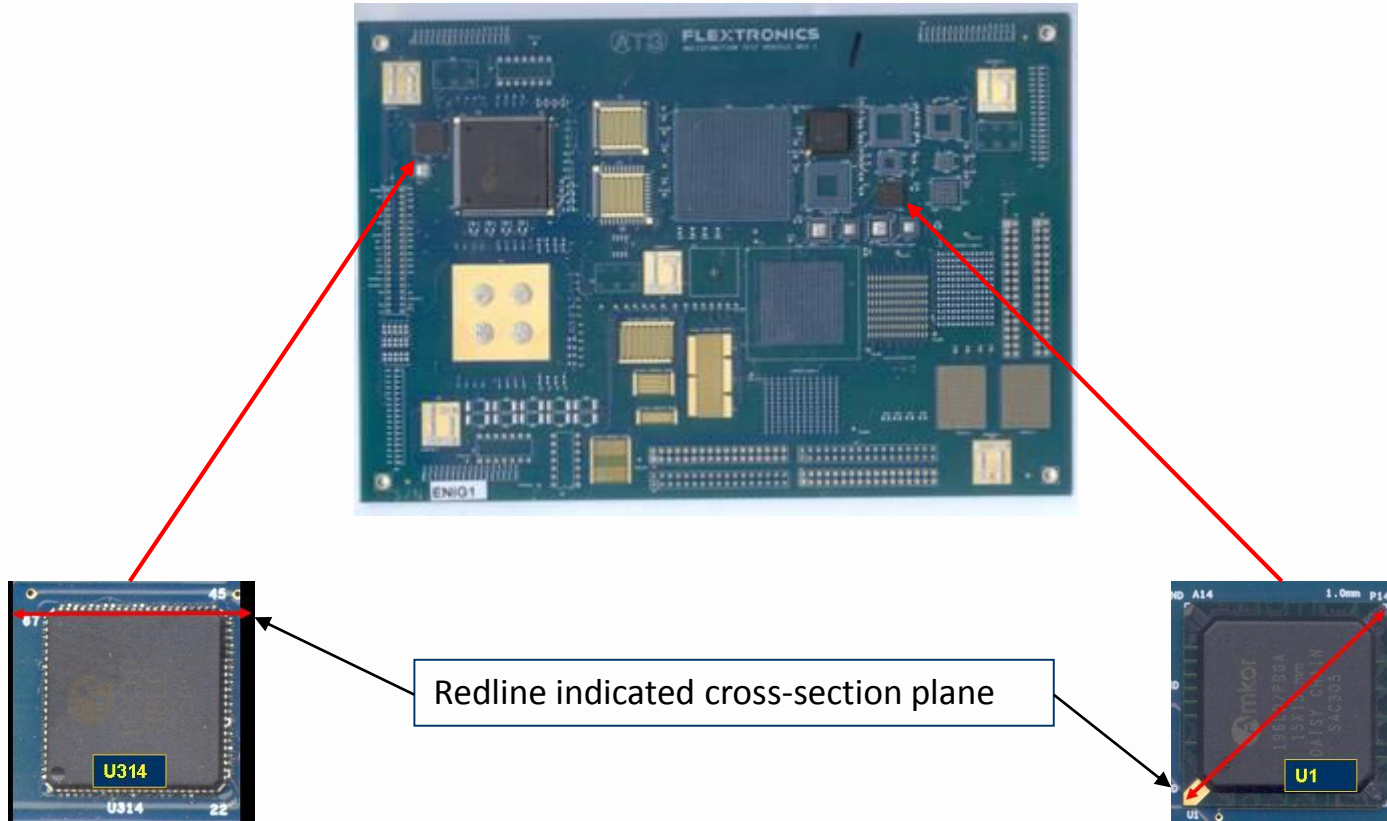

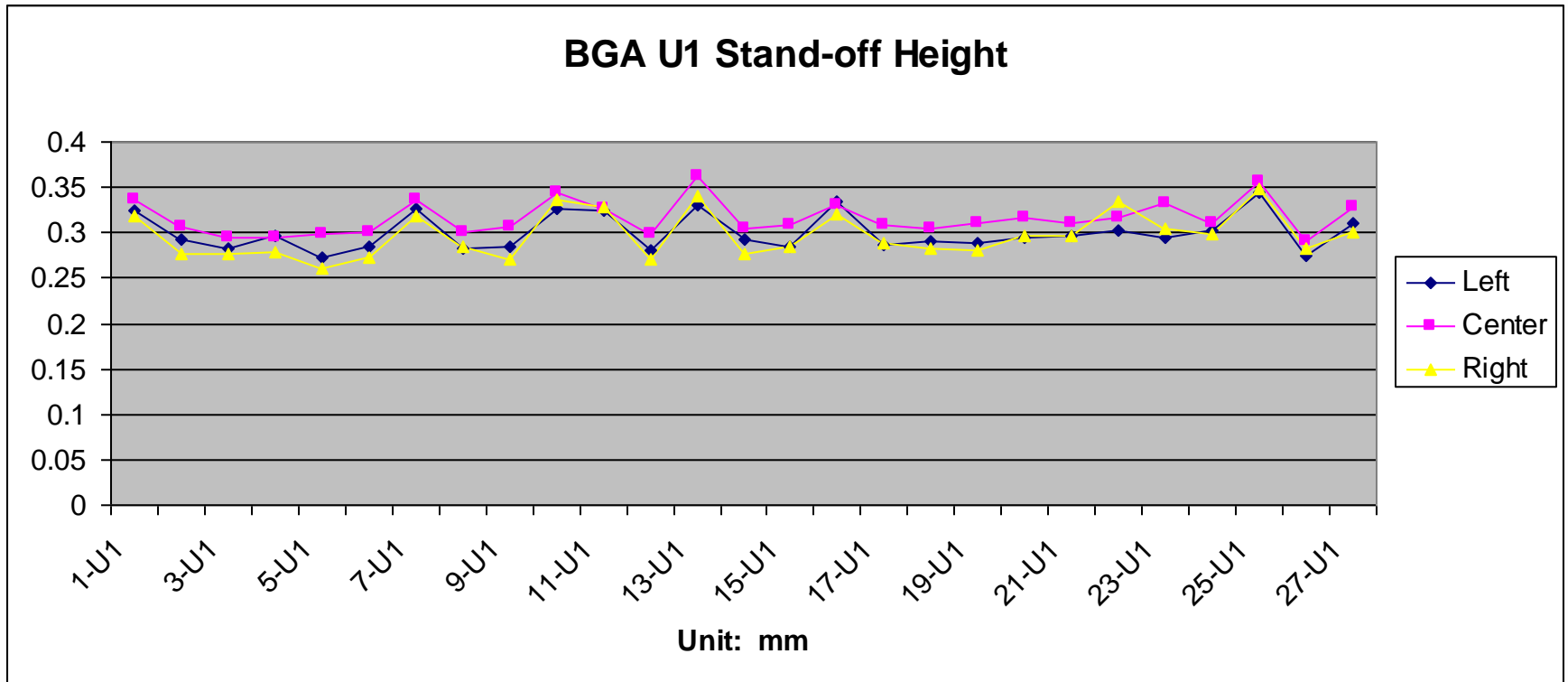



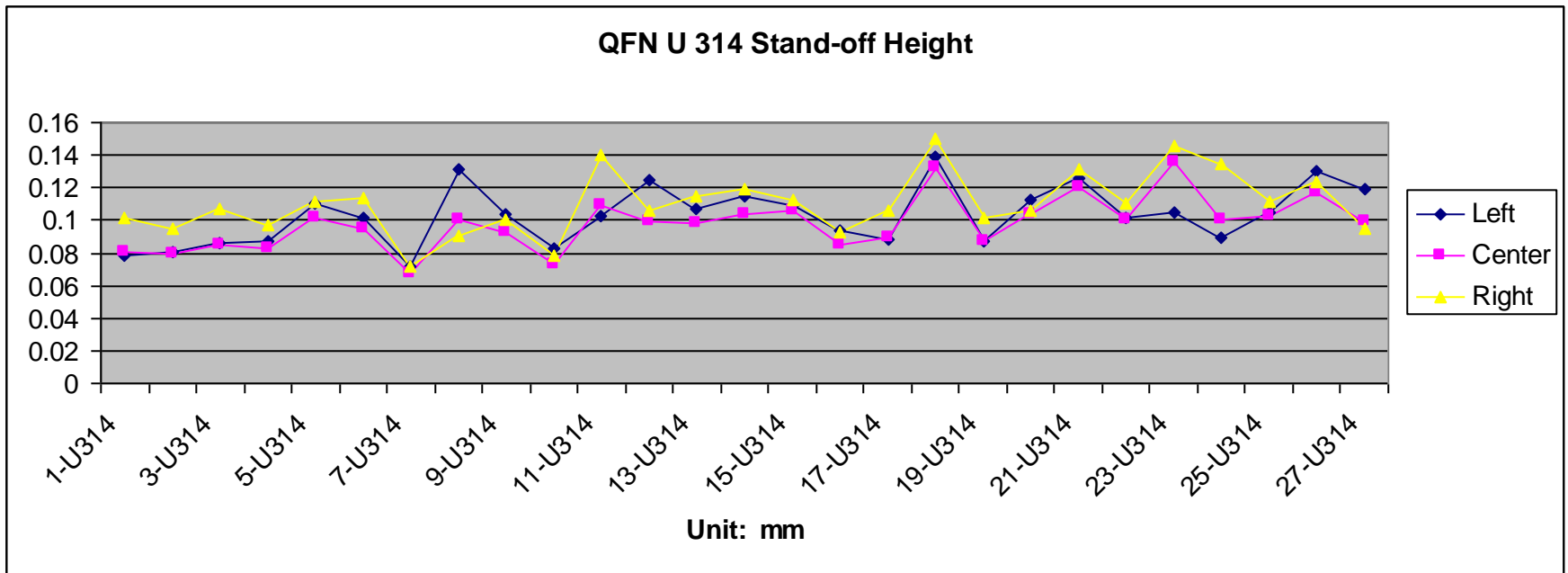

No Pre-Conditioning

3X Reflow

Aging (>6 months)

U1

U314

U1

U314

U1

U314

OSP

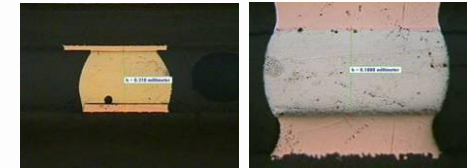
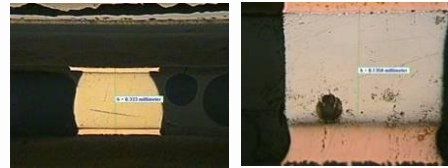
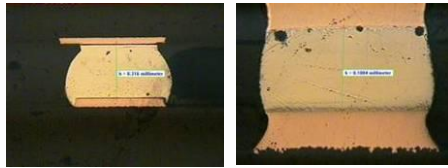

U1

U314

U1

U314

U1

U314

PF

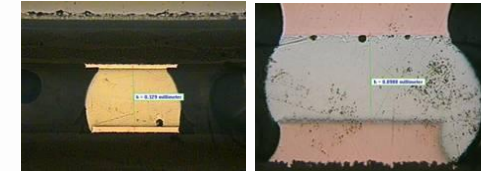
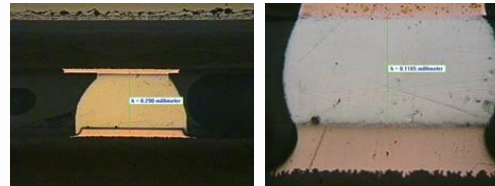
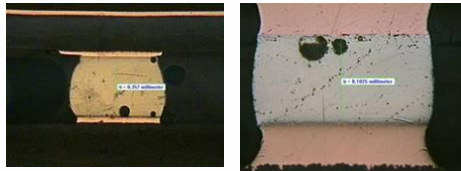

U1

U314

U1

U314

U1

U314

ENIS

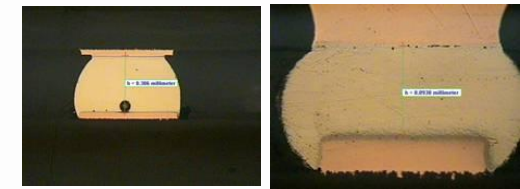
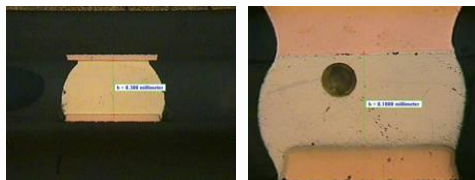
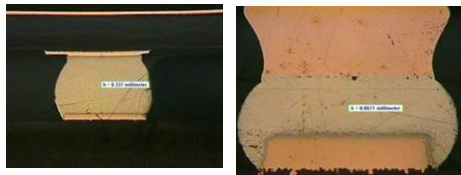

No Pre-Conditioning

3X Reflow

Aging (>6 months)

U1

U314

U1

U314

U1

U314

IAG w/  
PF

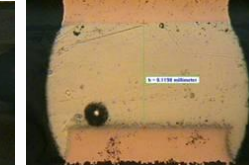
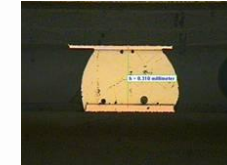
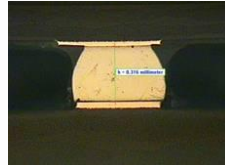
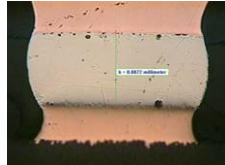
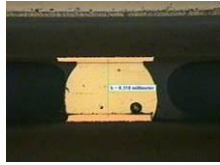

U1

U314

U1

U314

U1

U314

IAG w/o  
PF

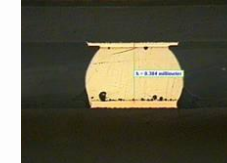
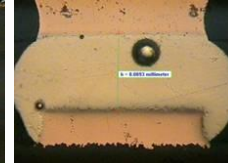
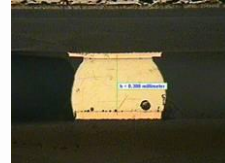
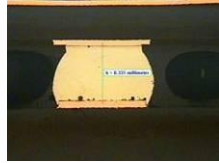

U1

U314

U1

U314

U1

U314

ENEPIG  
w/ PF

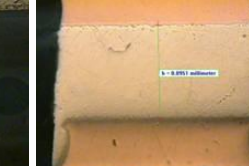
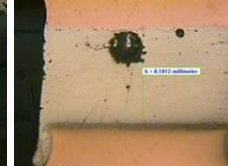

No Pre-Conditioning

3X Reflow

Aging (>6 months)

U1

U314

U1

U314

U1

U314

ENEPIG  
w/o PF

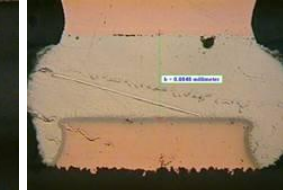
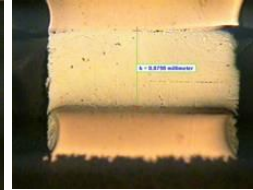
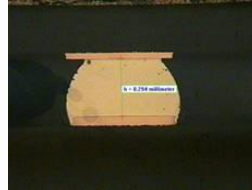
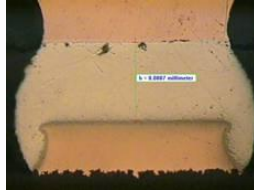
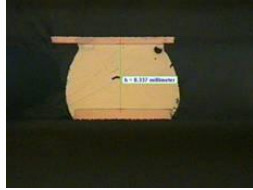

U1

U314

U1

U314

U1

U314

Hi-P ENIG  
w/ PF

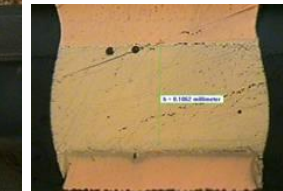
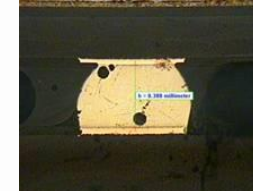
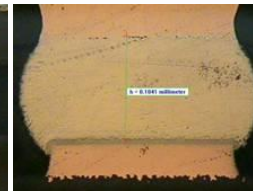
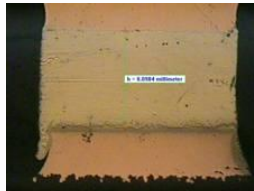
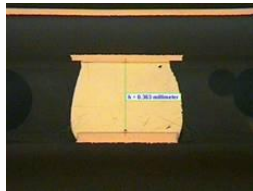

U1

U314

U1

U314

U1

U314

Hi-P ENIG  
w/o PF

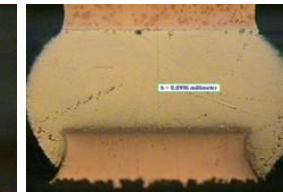
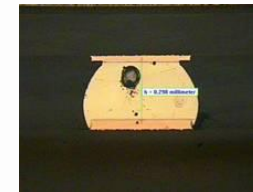
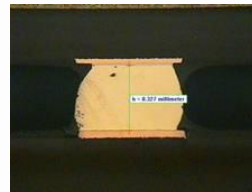

- Voiding was found on pins of QFN (U314). This was not captured in 5DX as algorithm on QFN pins was checking for open/short solder.
- Comparing PCB with Immersion Silver (IAG), Electroless Nickel / Immersion Gold Hi-Phosphorous (Hi-P ENIG), and Electroless Nickel / Electroless Palladium / Immersion Gold (ENEPIG) surface finish with and without Plasma Finish (PF) protection, there was no benefit on adding PF.
- Cross-section on PF found micro-voiding at pad to ball interface. This was not found on OSP or other surface finish.
- PCB aging for 8 hrs at 72°C & 85% R.H. (> 6 months shelf life) had increased voiding at QFN pins for most surface finishes.



NEW IDEAS ... FOR NEW HORIZONS

**MARCH 25-27, 2014**

MANDALAY BAY RESORT AND  
CONVENTION CENTER

LAS VEGAS, NEVADA

# Summary

- New surface finishes evaluated are:
  - Plasma Finish (PF)
  - Electroless Nickel / Immersion Silver (ENIS)
  - Electroless Nickel / Immersion Gold Hi-Phosphorous (Hi-P ENIG)
  - Electroless Nickel / Electroless Palladium / Immersion Gold (ENEPIG)
- PF coating was applied on IAg, ENEPIG, and Hi-P ENIG as a protective layer to verify any performance difference.
- There was no significant improvement on OSP versus PF, or surface finishes with PF added.
- We observed copper discoloration after reflow on PCB with PF only, and micro voiding at pad interface.
- We suspect the micro voiding at pad interface on PF was due to copper oxidation, thus visually we can see the discoloration also.

- Pictures of PF discoloration and micro voiding issue.

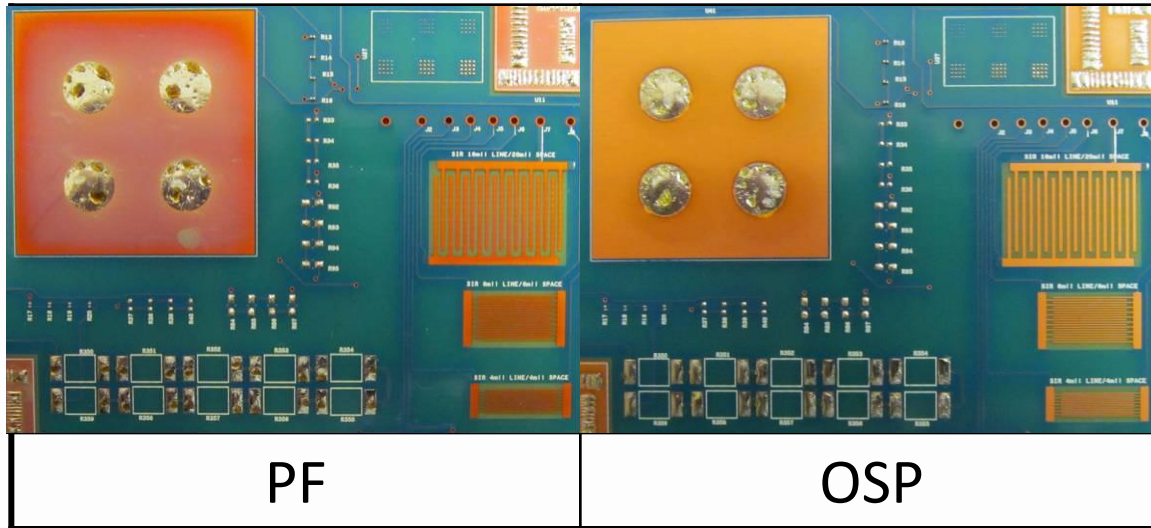

No Pre-Conditioning

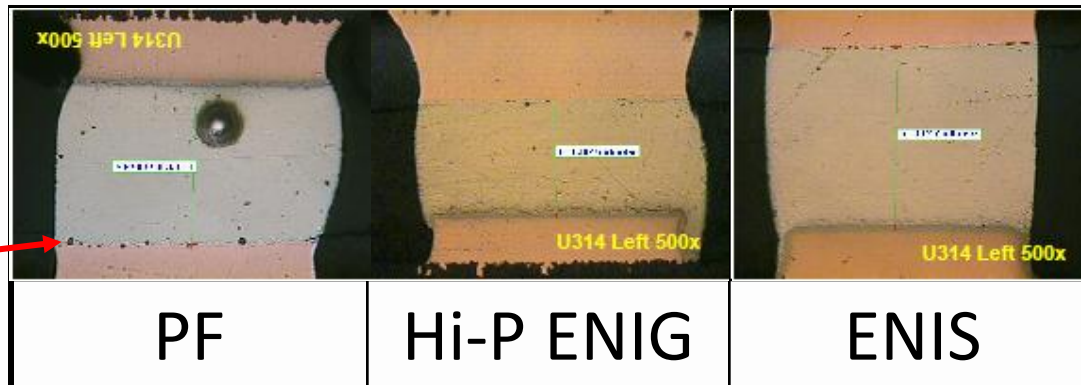

Cross-Section

Micro voiding →

PF

Hi-P ENIG

ENIS

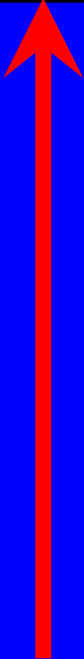

**Rating**

	Fresh Conditions	Three Times Reflow	Storage Simulation
Better 	Hi-P ENIG	Hi-P ENIG	Hi-P ENIG ENEPIG
	ENEPIG IAg ENIS	ENEPIG	IAg ENIS OSP
	OSP	IAg ENIS OSP	IAg ENIS OSP
	PF	PF	PF

Note: Surface finishes within one box have similar performance



NEW IDEAS ... FOR NEW HORIZONS

**MARCH 25-27, 2014**

MANDALAY BAY RESORT AND  
CONVENTION CENTER

LAS VEGAS, NEVADA

**Thank You**