

What is Kelvin Test?

Rick Meraw and Todd Kolmodin, Gardien Services USA
Manfred Ludwig, Gardien Services China
Holger Kern, Gardien Services Germany

Introduction

The PCB industry is ever changing and adapting to new technologies. OEM specifications and requirements have also advanced due to these technologies. In some cases the OEMs are asking for a low resistance test to be performed on some or all electrical test nets of the PCB or on the holes of the PCB. This requirement is typically not well defined on the fabrication drawing and that leads to misleading conclusions by the fabrication house.

4-Wire Kelvin testing has been around for many years but using this type of measurement on bare PCB's is a relatively new requirement. The requirement for PCB 4-Wire Kelvin testing was originally requested by digital commercial OEMs in the US with the aim to set out to improve the overall quality of the products. The first 4-Wire Kelvin test requirement for PCB's were on a limited hole criteria. Since that time automotive companies in Japan have also adopted such requirements. Medical applications are also joining in with their own 4-Wire Kelvin requirement.

This paper will use the data gathered by the company's operations to outline what a 4-wire Kelvin test is and how it can be used. Several examples will be illustrated of what the 4 wire Kelvin test can and cannot do. A clear definition of what limitations are present during the testing operation will be defined. The paper will assist designers in understanding how the low resistance test can assist them and also identify causes that can identify unwanted concerns/issues.

What is 4-Wire Kelvin test?

If you have used an ohmmeter to make resistance measurements you have probably heard of terms such as 2-wire and 4-wire measurements.

When you use an ohmmeter to measure the resistance of a trace touching one lead to the one end of the trace and the other end to the other end of the trace completes the circuit and allows for current to flow through the trace. Once current is flowing, a simple ohms law calculation can be used to calculate the resistance as indicated in Figure 1.

Figure 1 shows a conventional ohmmeter that forces current through the wire, it measures the voltage that develops, calculates the resistance, and displays the result.

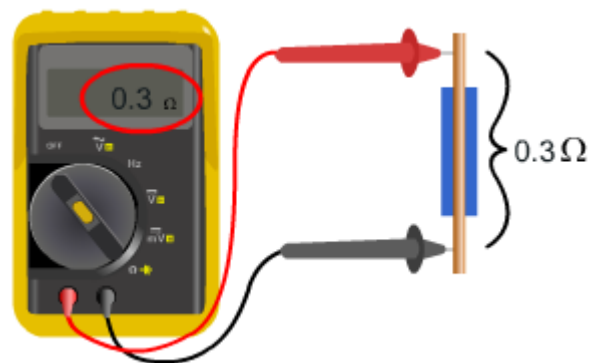
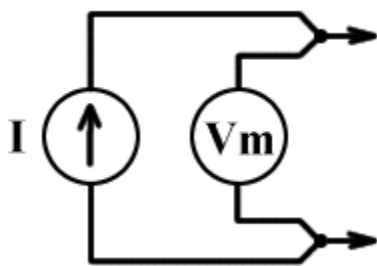


Figure 1

The lead resistance is added into the total resistance. In this example (Figure 2) 1 ohm lead resistance has been added into the final resistance of 2 ohms.

Ohms Law: Resistance = Voltage/Current

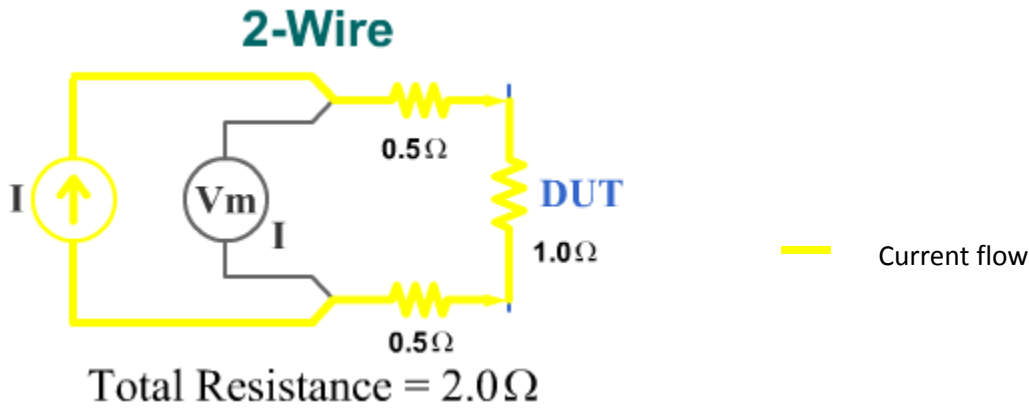


Figure 2

In the case of a PCB flying probe tester the circuitry would be similar to that shown in Figure 3.

A flying probe machine basically contains a high speed ohmmeter that allows the user to quickly gather resistance values for several nets on the PCB. A 4-wire measurement system will perform a similar action with greater accuracy.

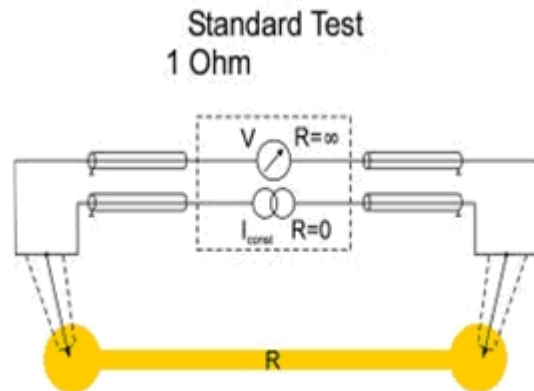


Figure 3

On a 4-wire Kelvin measurement system a constant current is forced through the force lines negating the current flow through the volt meter. This completely isolates the voltmeter to create a highly accurate resistance measurement.

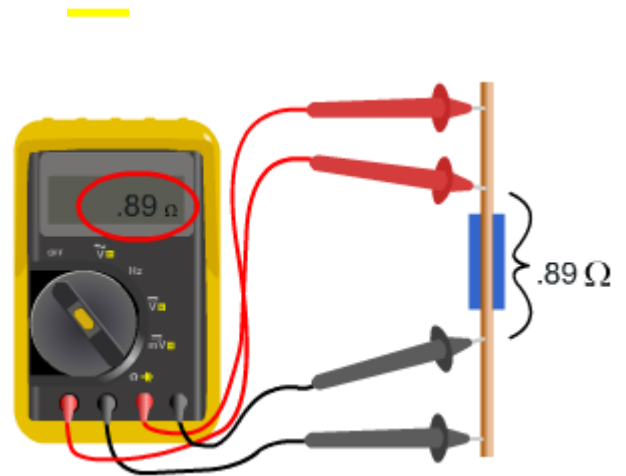
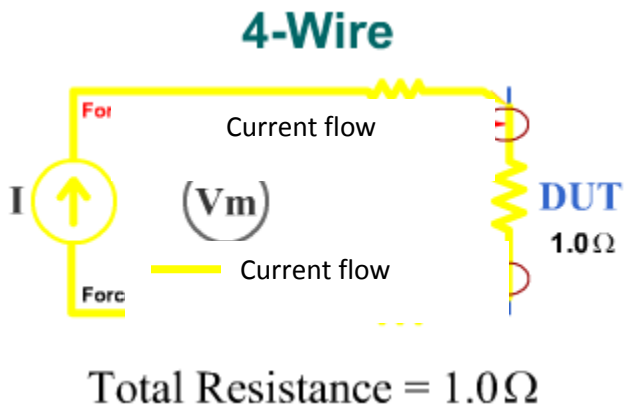


Figure 4:

In the case of a PCB flying probe tester the circuitry would be similar to that shown in Figure 5. Two probes are placed on the same pad allowing the lead resistance to be removed from the measurement. Lead resistance in a conventional flying probe tester is the wire that runs from the probe to the measurement system.

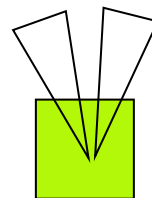
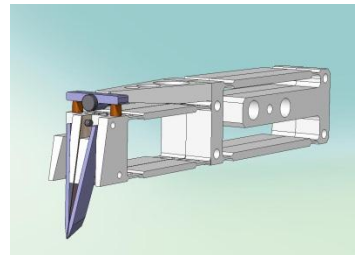
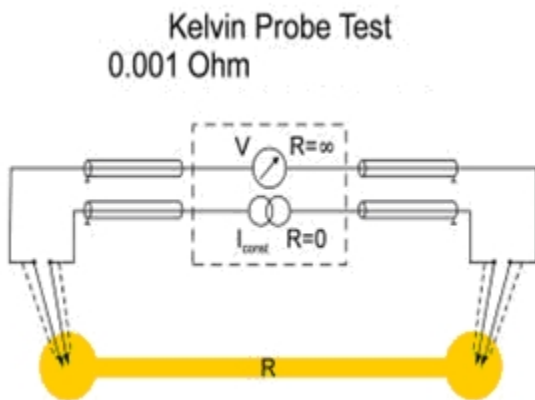


Figure 5:

4-wire Kelvin testing is a methodology where high resolution measurements are taken to determine finite changes in resistance. These finite changes in resistance can then be used to locate plating defects or variations in plating thickness. The kelvin test is highly accurate because of a four terminal system that negates all current sources, lead and contact resistances.

This allows for the finite measurements to only be measured on the PCB circuitry. Typically these measurements are in the milliohm range.

What can 4-Wire Kelvin detect?

Figure 6 shows examples of what the 4-Wire Kelvin Test can uncover. These types of defects may pass the standard Electrical Test. Changes in copper thickness do not effect resistance enough to cause a fault at the 5 or 20 Ohm standard electrical test continuity threshold.

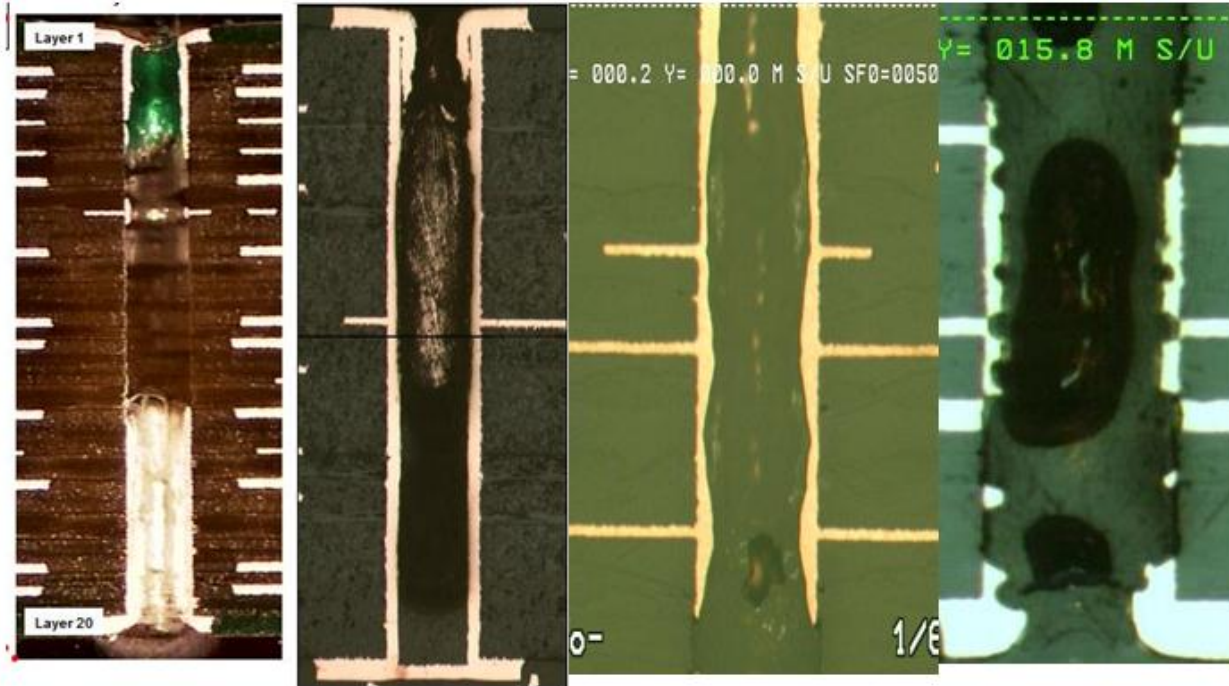


Figure 6:

Using the 4-Wire Kelvin test these hidden PCB defects can be detected before the boards are populated. Cosmetic PCB defects are easily found on the outer areas of a PCB board by using Automated Visual Inspection machines. Hidden defects such as hole integrity can only be efficiently located by requiring a 4-Wire Kelvin test.

How the 4-wire Kelvin test detects hidden PCB defects

4-Wire Kelvin test will find the milliohm resistance changes from hole to hole.

This looks very easy now however the test in production is far from perfect at this time. Most systems on the market are very good at measuring what there is but not so good at calculating what should be there and determining a pass or fail from that stage. This leads to a complex process of determining a pass from a failure. The typical process would be to measure a few boards or panels and determine a running average on the resistance measurements. Any resistance value that fall outside a certain threshold would be flagged as failures. When the test is specifically targeting barrels, variations in the plating thickness can be detected relatively easily. When the test is performed on a trace, depending on the length and width, the variations can have a more profound effect on the measurement. The current comparison test is good, but far from perfect in this case.

Once a barrel has been identified as a failure the only way to know for sure if it is defective would be to perform a destructive test on the hole by cross-section.

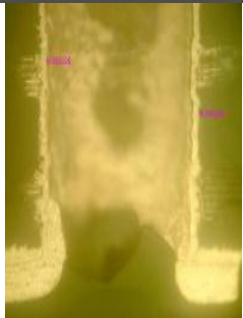


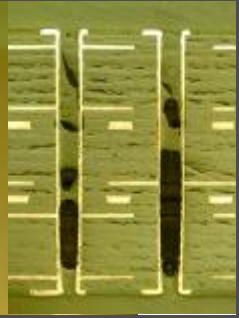

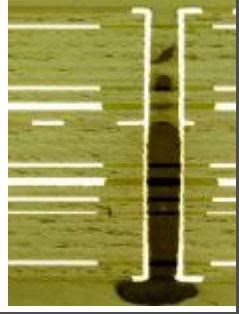
Measured Value (mΩ)	Expected Value (mΩ)	Difference	Section		Defect Found
12.0467	3.8528	212.7%			Plugged hole void
12.0296	5.3367	125.4%			Plugged hole crack
16.3125	3.5979	353.4%			Plugged hole crack

Figure 7: Examples of failures detected by the 4-wire Kelvin test.

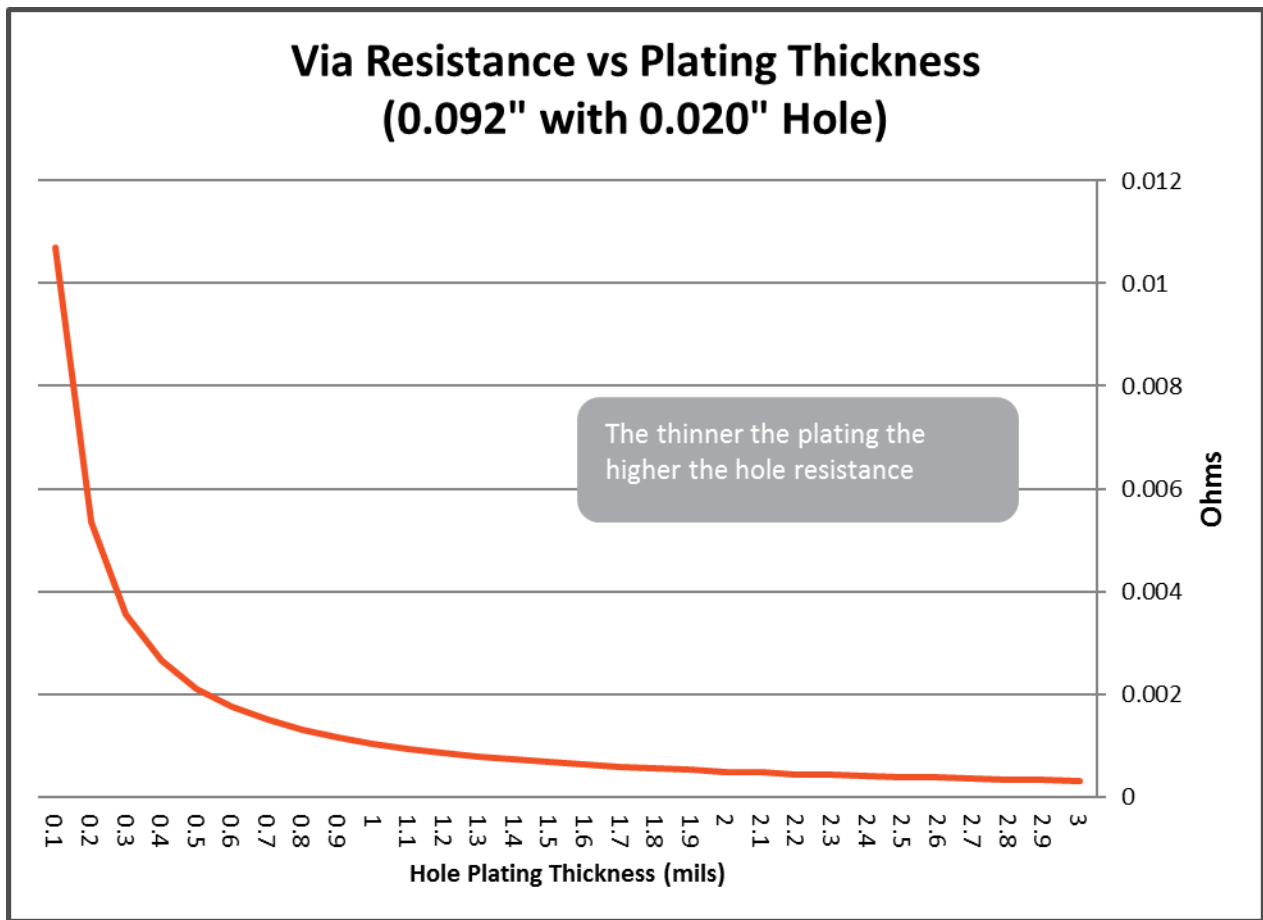


Figure 8: Via Resistance versus Plating Thickness

The most efficient way to perform a barrel integrity check would be in panel form, after the panel has been etched. As an OEM you would be looking for uniformity in measurements from panel to panel (comparing hole A on panel 1 to hole A on panel 2, etc). In the event that uniformity cannot be found a deeper investigation would need to begin in order to determine why.

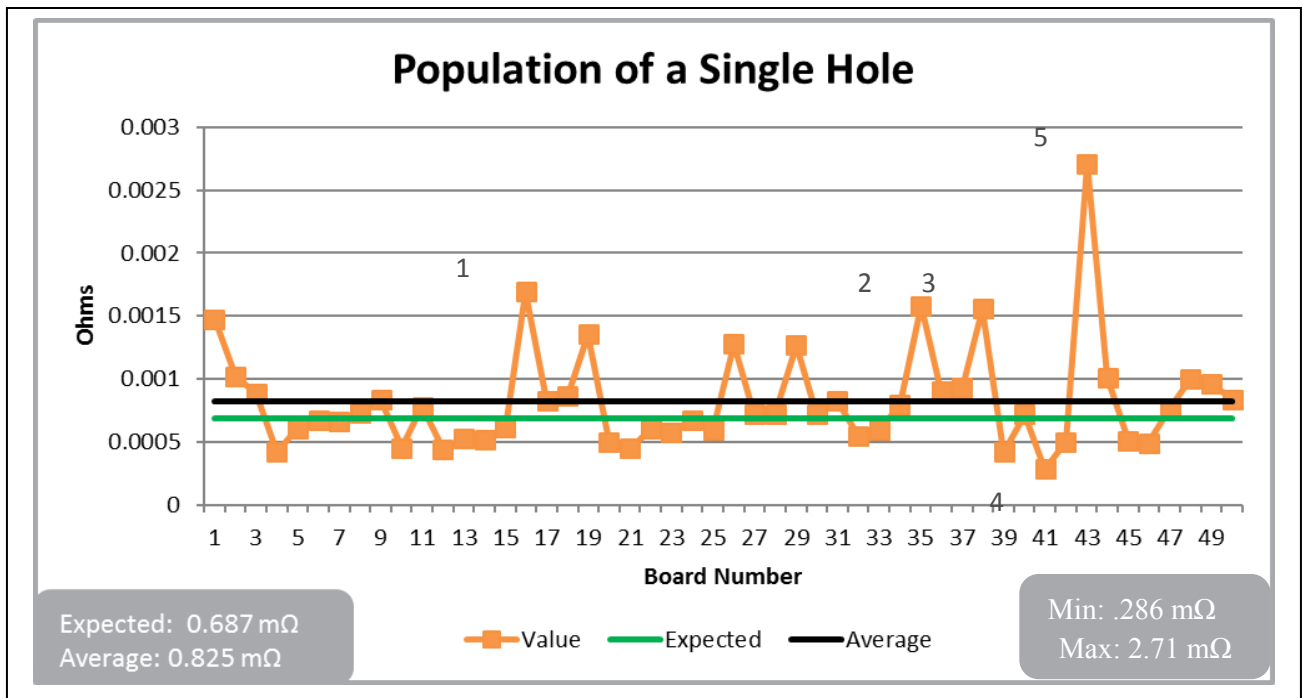


Figure 9: Example of analysis of measurements of uniformity from board to board.

Points 1, 2, & 3 all had cracks and thin plating (plugged holes).

Point 4, had 2.7 mils of copper in the hole

Point 5, had 0.24 mils of copper extremely thin plating because of plugged hole

Defects in circular nets are not detected in conventional ET testing. Typically holes in large copper areas are used to transfer current from layer to layer. When one or more holes are voided there is a potential for the PCB fail. Figure 10 identifies what these holes would look like on a standard PCB

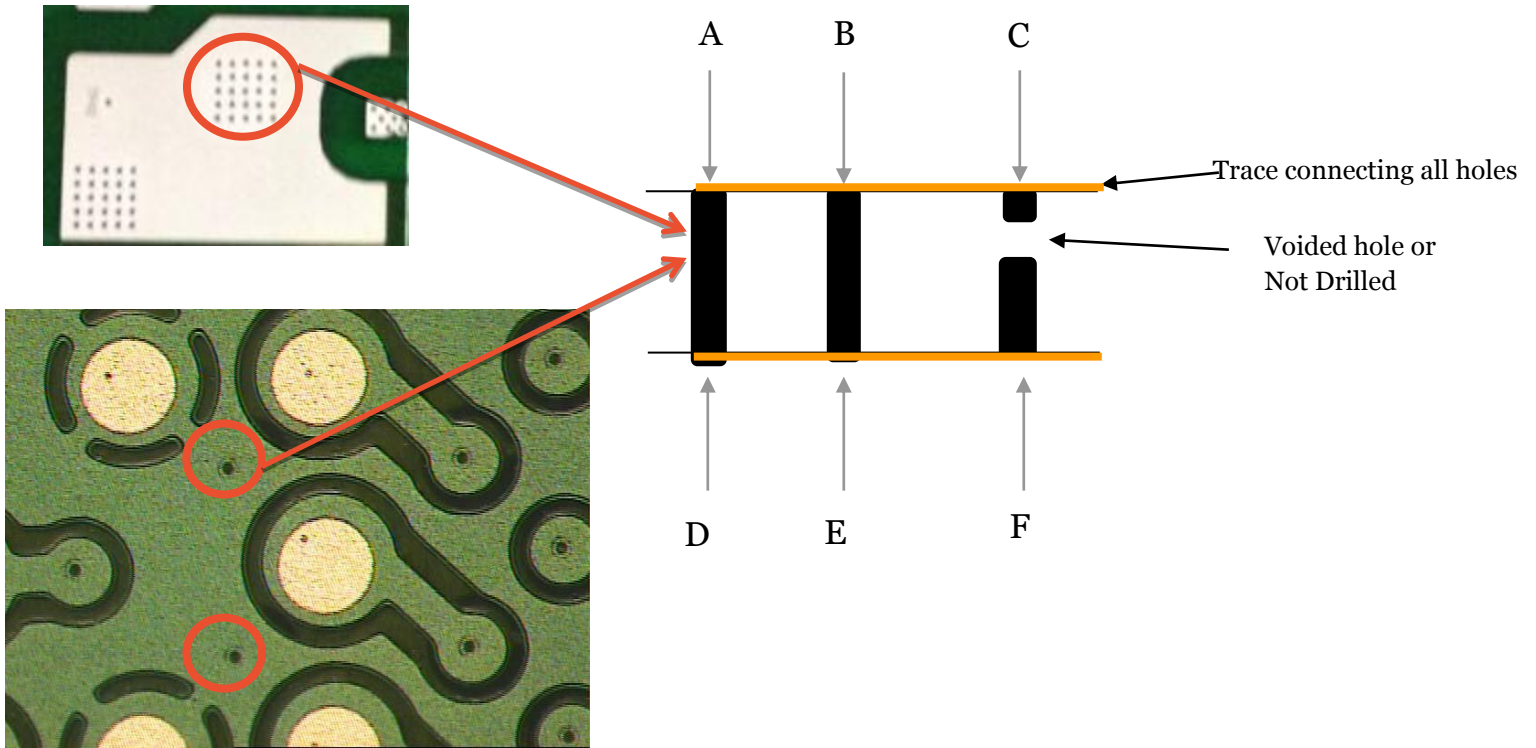


Figure 10:

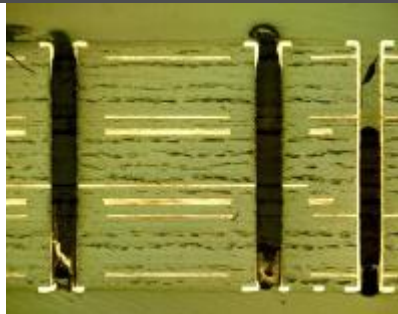
Measured Value (mΩ)	Expected Value (mΩ)	Expected Value (mΩ)	Section	Defect Found
56.0882	4.3259	1196.6%		Plugged hole void

Figure 11: Example of plugged hole voids detected using the 4-wire Kelvin test:

The 4-wire Kelvin test can help drive quality by testing for hidden defects by detecting unwanted plating defects.

Generating programs for the Flying Probe 4-Wire Kelvin test

When looking for barrel integrity, it is best to probe the barrel directly from one side to the other side. The barrel would have to be free of unwanted material such as solder mask. The connection to the annular ring/hole is imperative with the smallest variation causing an issue with the measurement. When generating programs it is best to ensure both sides of the barrel are tested in an overlapping fashion.

When looking for specific net resistance, it is important to test all pads open in the mask. This will allow for more accurate readings on each individual section of the network under test. It is not recommended to use end of node to end of node testing. The networks may be too long causing unwanted variations in the readings.

It should also be kept in mind that depending on the equipment used the size of the pad plays a significant role due to the contact area of the two probes onto the pad. If only one probe hits the pad the test will be jeopardized.

Other areas for consideration when using the 4-wire Kelvin Test

The test should be done prior to solder mask as an in-process QA step. It should not be performed as an FA process as the final board will not provide optimal or accurate results due mask on the via holes.

Due to excess copper travel the use of the Kelvin test for buried microvias would be at the users' discretion. The copper may add too much resistance to the master values and therefore allow a possible defect to go undetected.

Kelvin Testing for possible microvia copper issues would be done at the sub-part level.

For optimum test results the barrels would be probed directly from side to side. It would be best to test each hole twice using an overlapping pattern.

- 4-Wire Kelvin test is highly accurate and it is very time consuming due to multiple readings on the same points.
- The test itself is very expensive due to the cost of the equipment and know how on how to perform the test.

Conclusion

The paper discussed what the 4-wire Kelvin test is, what it can detect on PCBs versus standard flying probe testing such as plugged hole voids and cracks and thin plating as well as best practices when generating programs with the Flying Probe 4-wire Kelvin test. It also discussed some of the drawbacks of the test such as increased test time and cost of equipment.

OEM's are beginning to require more and more from their suppliers and the 4-wire Kelvin test is just one of the requirements on the horizon.

Future Work

With developing data on this test, it will be proposed to incorporate it into IPC-9252 standard document (1).

References

1. IPC 9252A standard with Amendment 1, Requirements for Electrical Testing of Unpopulated Printed Boards, 2012.

What is Kelvin Test? (Barrel Integrity)

Locate Hidden Defects In Your PCB Boards

Primary Author: Rick Meraw, Gardien Services USA
Co-authors: Todd Kolmodin, Gardien Services USA
Manfred Ludwig, Gardien Services China
Holger Kern, Gardien Services Germany

Introduction

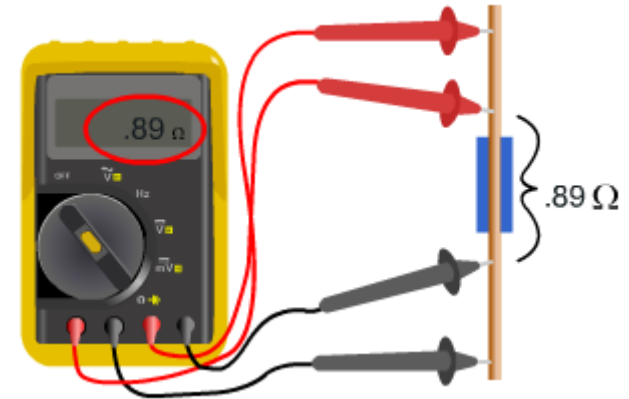
The PCB industry is ever changing and adapting to new technologies. OEM specifications and requirements have also advanced due to these technologies.

In some cases the OEM's are asking for a low resistance test to be performed on some or all electrical test nets of the PCB or on the holes of the PCB.

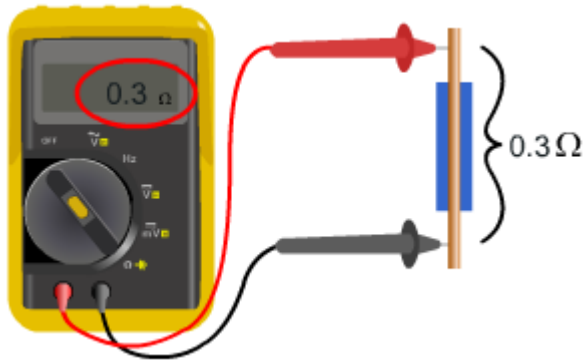
This requirement is typically not well defined on the fabrication drawing and that leads to misleading conclusions by the fabrication house.

What is 4-Wire Kelvin test?

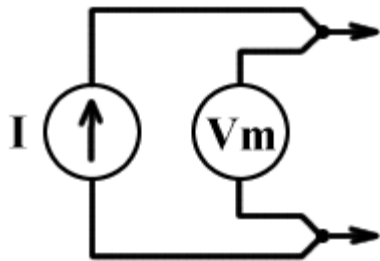
- If you've used an ohmmeter to make resistance measurements you've probably heard of terms like 2-wire and 4-wire measurements.
- When you use an ohmmeter to measure the resistance of a trace you touch one lead to the one end of the trace and the other end to the other end of the trace. This completes the circuit and allows for current to flow through the trace. Once current is flowing, a simple ohms law calculation could be used to calculate the resistance.



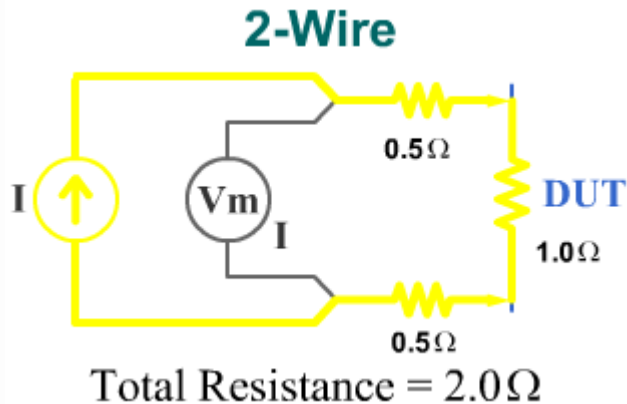
Example



The ohmmeter forces current through the wire. The voltage is measured and the resistance is calculated and displayed.



In this example 0.3 ohms

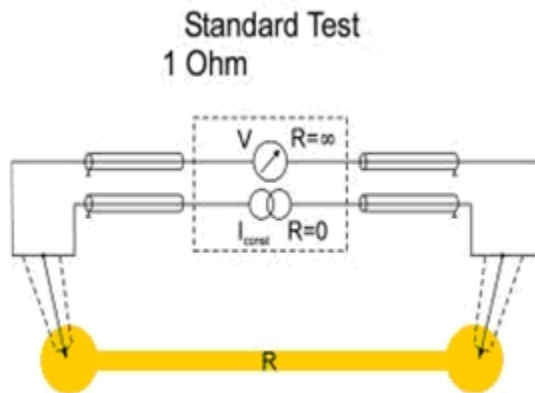


— Current flow

The lead resistance is added into the total resistance in this example 1 ohm lead resistance has been added into the final resistance of 2 ohms

Ohms Law: Resistance = Voltage/Current

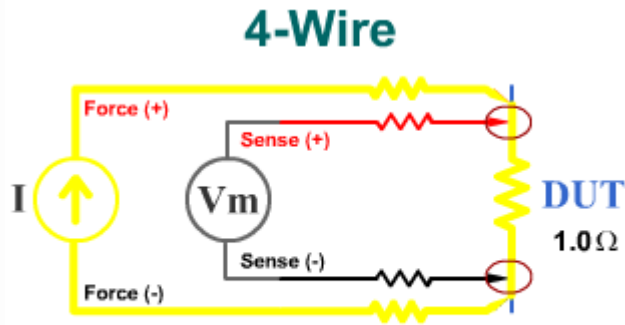
In the case of a PCB flying probe tester the circuitry would be more like this.



Standard Flying Probe machine are typically accurate to 1 ohm

A flying probe machine basically contains a high speed ohmmeter that allows you to quickly gather resistance values for several nets on your PCB.

A 4-wire measurements system will perform a similar action with greater accuracy.



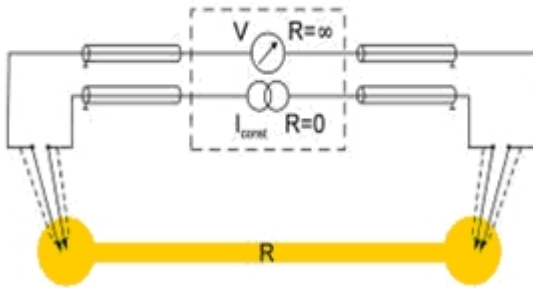
Total Resistance = $1.0\ \Omega$

— Current flow

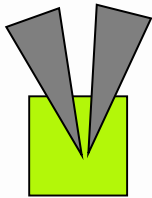
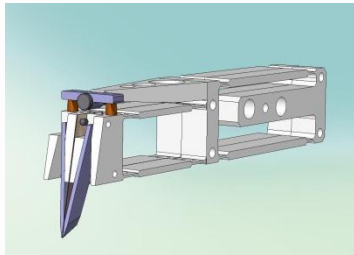
The “REAL RESISTANCE” is measured
at 1 ohm

On a 4-wire Kelvin measurement system a constant current is forced through the force lines negating the current flow through the volt meter. This completely isolates the voltmeter to create a highly accurate resistance measurement.

Kelvin Probe Test
0.001 Ohm



Typical probe



Probe under contact

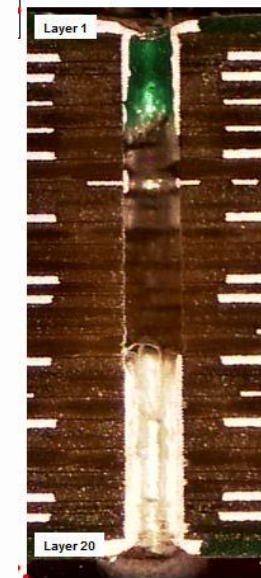
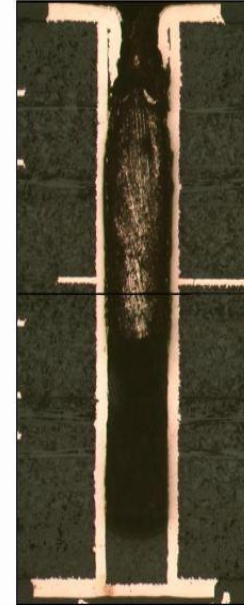
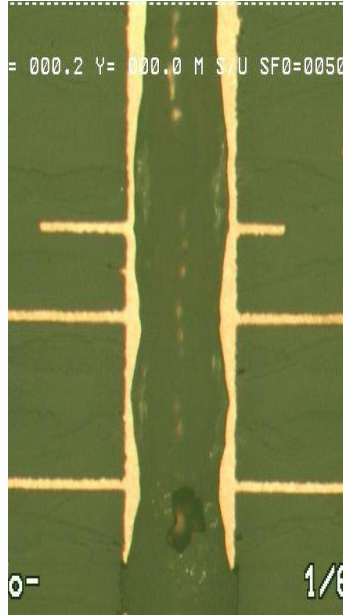
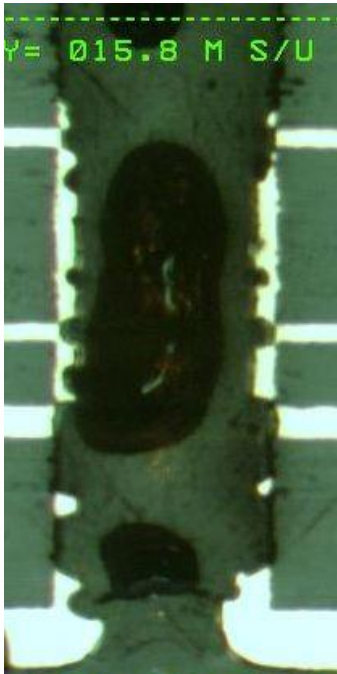
4-wire Kelvin testing is a methodology where high resolution measurements are taken to determine finite changes in resistance.

These finite changes in resistance can then be used to locate plating defects or variations in plating thickness.

The Kelvin test is highly accurate because of a four terminal system that negates all current sources, lead and contact resistances.

This allows for the finite measurements to only be measured on the PCB circuitry (Typically measurements in milliohm range).

What can 4-Wire Kelvin detect?



These types of defects may pass the standard Electrical Test. Changes in copper thickness do not effect resistance enough to cause a fault at the 5 or 20 Ohm standard electrical test continuity threshold.

Uncover these hidden defect before the boards are populated

How will 4-Wire Kelvin uncover these defects?

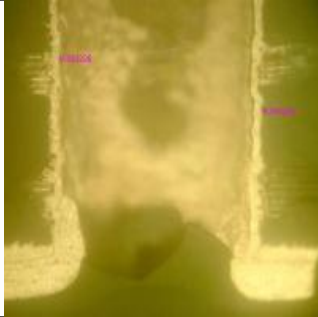


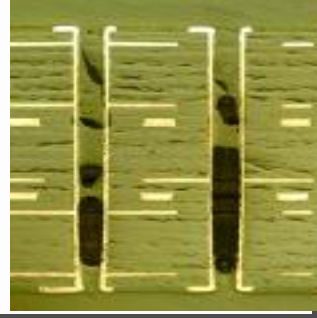

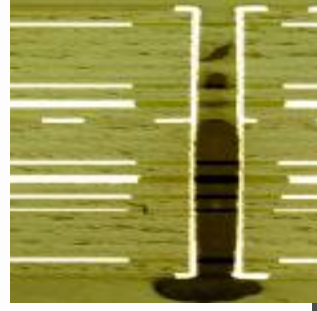
4-Wire Kelvin test will find the milliohm resistance changes from hole to hole. This all looks very easy now however the test is far from perfect at the moment.

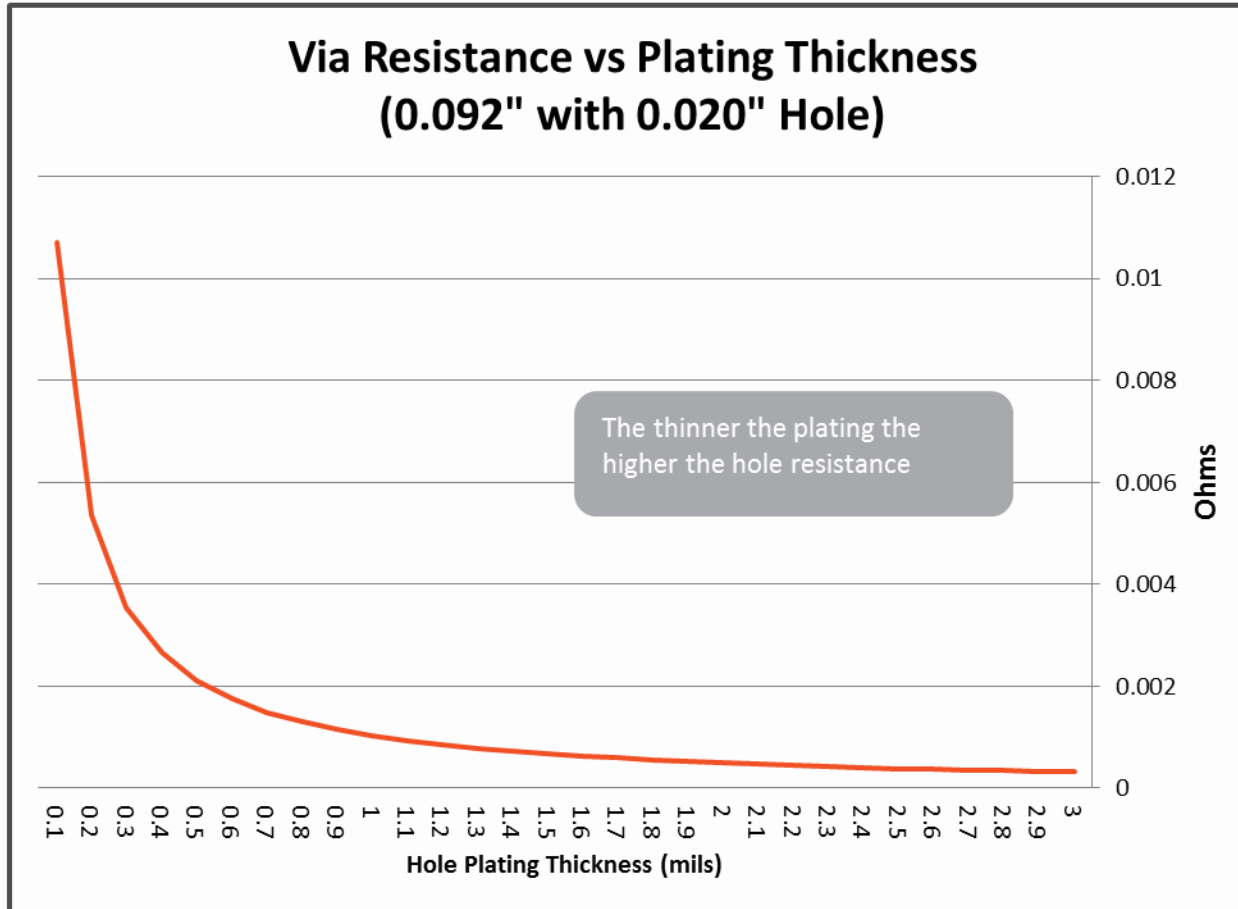
Most systems on the market are very good at measuring what is there but not so good at calculating what should be there and determining a pass or fail from there. This leads to a complex process of determining a pass from a failure.

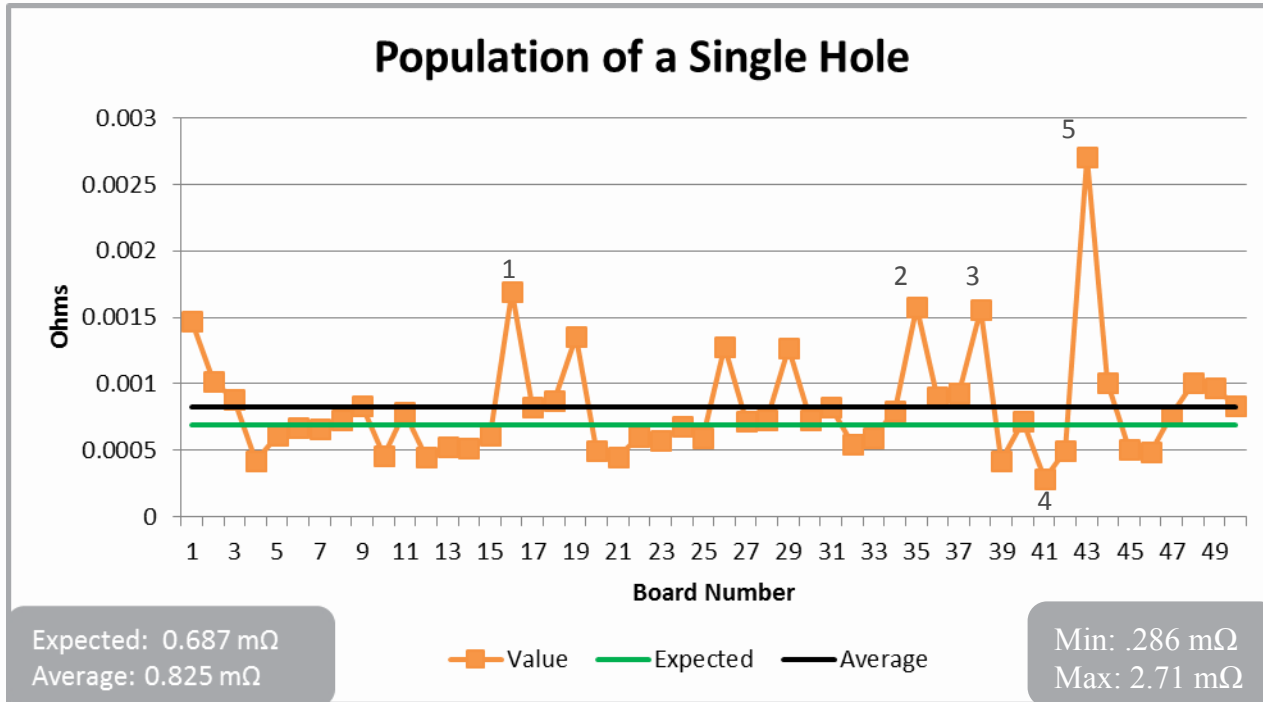
The typical process would be to measure a few boards or panels and come up with a running average on the resistance measurements. Any resistance value that fall outside a certain threshold would be flagged as failures.

When the test is specifically targeting barrels, variations in the plating thickness can be detected relatively easily.

When the test is performed on trace depending on the length and width the variations can have a more profound effect on the measurement. The current comparison test is good, but far from perfect in this case.

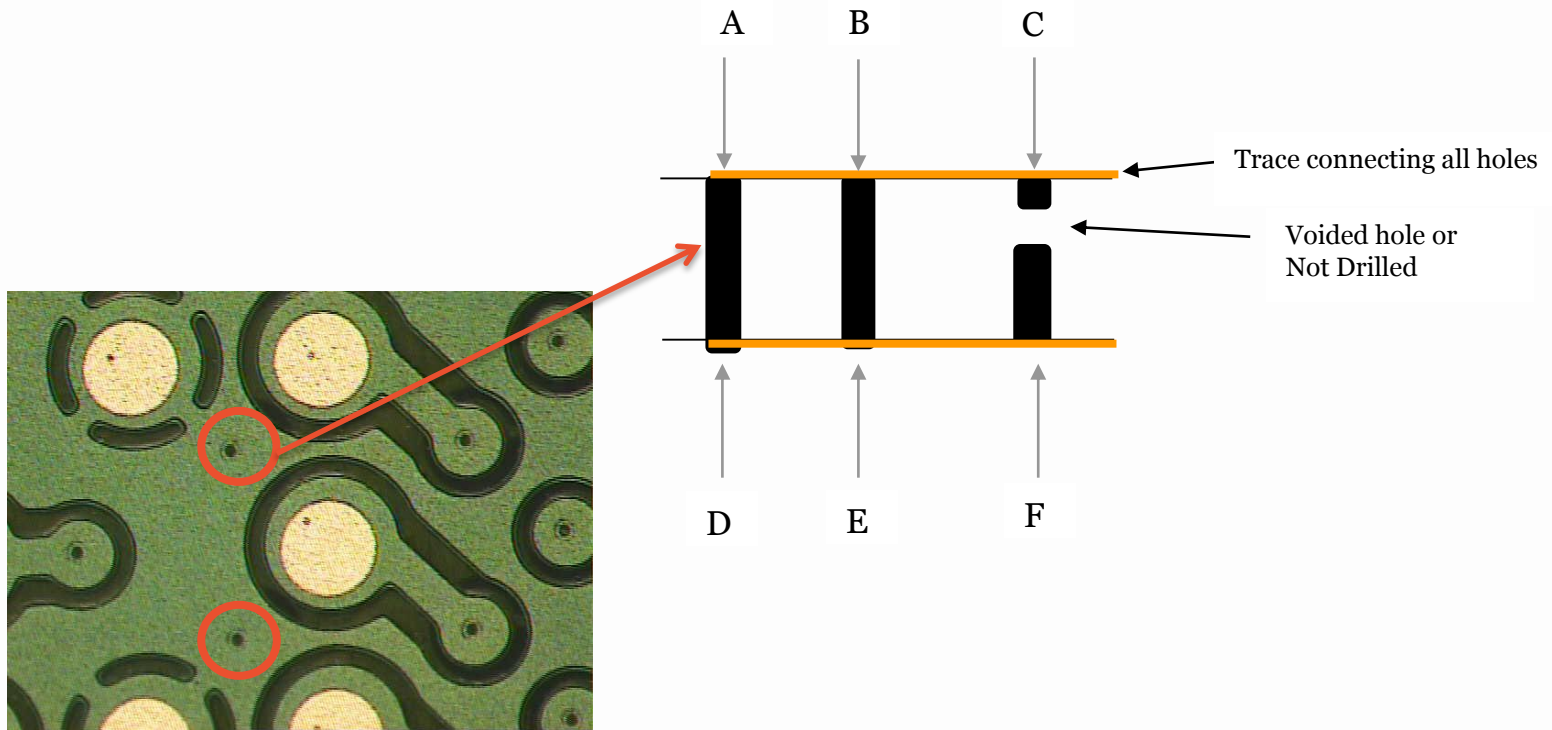
Measured Value (mΩ)	Expected Value (mΩ)	Difference	Section		Defect Found
12.0467	3.8528	212.7%			Plugged hole void
12.0296	5.3367	125.4%			Plugged hole crack
16.3125	3.5979	353.4%			Plugged hole crack





Points 1, 2, & 3 all had cracks and thin plating (plugged holes).
 Point 4, had 2.7 mils of copper in the hole
 Point 5, had 0.24 mils of copper extremely thin plating because of plugged hole.

4-Wire Kelvin test can also detect voids in circular nets, typically power or ground nets.



Drive quality by uncovering these hidden defects

How to generate your programs for your Flying Probe 4-Wire Kelvin test?

When looking for barrel integrity?

It is best to probe the barrel directly from one side to the other side.

The barrel would have to be free of unwanted material such as solder mask. The connection to the annular ring/hole is imperative, the slightest variation with throw off the measurement system.

When generating your programs it is best to ensure both sides of the barrel are tested in an overlapping fashion.

How to generate your programs for your Flying Probe 4-Wire Kelvin test? (Cont.)

When looking for specific net resistance?

It is important to test all pads open in the mask. This will allow for more accurate readings on each individual section of the network under test.

Do not use end of node to end of node testing. The networks may be too long causing unwanted variations in the readings.

Please keep in mind that depending on the equipment used the size of the pad plays a significant role due to the contact area of the two probes onto the pad. If only one probe hits the pad the test will be jeopardized.

Other areas for consideration when using the 4-wire Kelvin Test

- Kelvin Test should be done prior to soldermask as an in-process QA step. It should not be performed as an FA process as the final board will not provide optimal or accurate results due mask on via holes.
- Due to excess copper travel the use of Kelvin for buried microvias is at the vendors discretion. The copper may add too much resistance to the master values and therefore allow a possible defect to go undetected.
- Kelvin Testing for possible microvia copper issues should be done at the sub-part level.
- For optimum test results the barrels must be probed directly from side to side. It is best to test each hole twice using an overlapping pattern.

Conclusion

The paper discussed what the 4-wire Kelvin test is, what it can detect on PCBs versus standard flying probe testing such as plugged hole voids and cracks and thin plating as well as best practices when generating programs with the Flying Probe 4-wire Kelvin test. It also discussed some of the drawbacks of the test such as increased test time and cost of equipment.

OEM's are beginning to require more and more from their suppliers and the 4-wire Kelvin test is just one of the requirements on the horizon.

Thank you for attending.

Questions?