

Rework of New High Speed Press Fit Connectors

Lars Bruno, Ericsson AB
Stockholm, Sweden
HDP User Group Project

Abstract

More and more people and things are using electronic devices to communicate. Subsequently, many electronic products, in particular mobile base stations and core network nodes, need to handle enormous amounts of data per second. One important link in this communication chain is high speed pressfit connectors that are often used to connect mother boards and back planes in core network nodes.

These new high speed pressfit connectors have several hundreds of thin, short and weak pins that are prone to damage. Small variations in via hole dimensions or hole plating thickness affect the connections; if the holes are too small, the pins may be bent or permanently deformed and if the holes are too large they will not form gas tight connections.

An example of deformed high speed connector pressfit pins inserted in plated holes of different sizes is given in Figure 1.

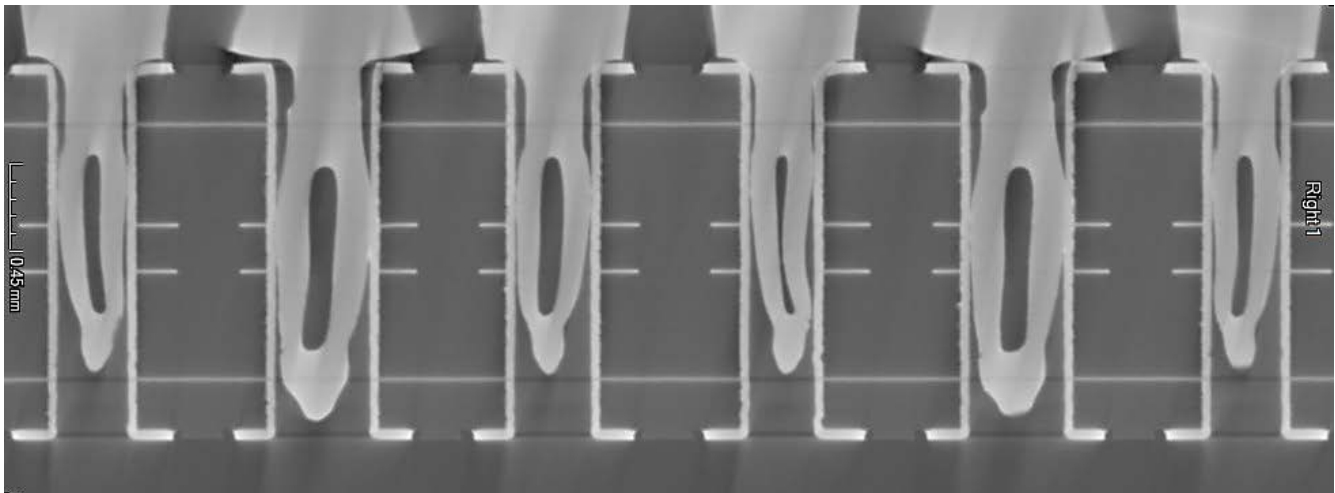

Figure 1 –3D CT x-ray image of deformed high speed pressfit connection pins¹.

The goal of this project was to understand how rework of these new high speed pressfit connectors affects connection strengths, hole wall deformations and plating cracks.

I. Introduction

This paper has its roots in the need to perform multiple reworks of an early version of a new family of high speed press fit connectors with a sensitive mechanical build up. The challenge has been to press in the thin and weak needle eye pins correctly. Different variants of this press fit connector, with slightly different pin geometries and materials, were shown to give damages of different kinds in the plated holes during rework. After several redesigns, this specific high speed pressfit connector became more robust, but the need to find out more about the effects of rework for this type of connector remained.

Because there is an increased market need, with several other high speed pressfit connectors about to be introduced, there is a general need to evaluate the damages that multiple reworks could cause.

Basically no information about rework of these new press fit connectors have been published, which increased the necessity of performing this investigation.

¹ Picture source: Jesper Wittborn, Ericsson AB, Kista, Sweden.

II. Methodology

This evaluation included rework from zero up to three times of a selected group of new high speed connectors on test boards with different hole plating and hole sizes covering the complete hole diameter tolerance range for each connector.

After the rework, three different evaluations were performed.

A. Single Pin Insertion and Retention Strength Test

The forces to press in and to pull out single pins from each of the tested connectors were measured in order to find out if the connection strengths had been affected by the rework.

B. Gas Tightness Test

By measuring the electrical resistance between plated hole walls and press fit pins, before and after subjecting assemblies to aggressive gas, possible hole wall cracks or general bad connections between pins and hole walls could be detected. Hole wall plating cracks would mean that corrosion should have taken place during the storage in aggressive gases and this would increase the electrical resistance.

C. Cross Sectioning

In order to better understand the results from the insertion, retention and the gas tightness tests, precision cross sections of the holes with connector pins have been performed. The hole wall deformation and other board damages have been studied as well as the shape of the needle eye pins in the holes.

III. Test Materials

The connectors and test boards used in this study are described below.

A. New High Speed Press Fit Connectors

Four new high speed connectors, named A, B, C and E, were chosen for this rework evaluation. One old connector, named D that is not considered to be a high speed connector, was used as a reference.

In order to better understand the results from the rework tests, thorough pin measurements were performed for each of the connectors.

A.1–High Speed Press Fit Connector A

High speed press fit connector A had slightly bigger pins than the other tested high speed press fit connectors. The recommended board hole diameter was $0.46 \text{ mm} \pm 0.05 \text{ mm}$, both for the ground pins and for the signal pins.

A photo of the bottom side of the package showing the compliant press fit pins is given in Figure 2.

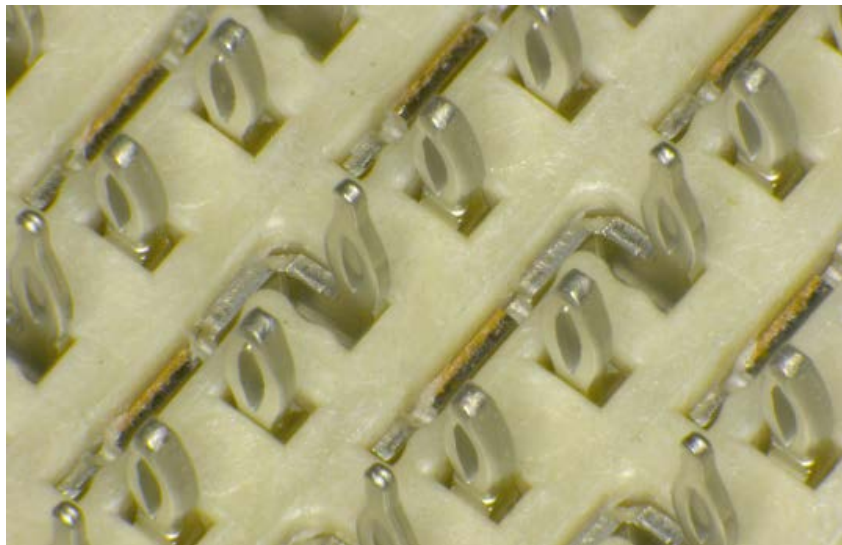

Figure 2 – Press fit pins for high speed connector A².

As can be seen in Figure 2, every third pin is a ground pin and the shapes and sizes between the signal pins and ground pins differ.

² All component lead photos and the component lead measurements in this report have been taken by Jesper Wittborn or Torgny Dahl at Ericsson AB, Kista, Sweden.

Measurements of the signal pins for connector A are shown in Figure3.

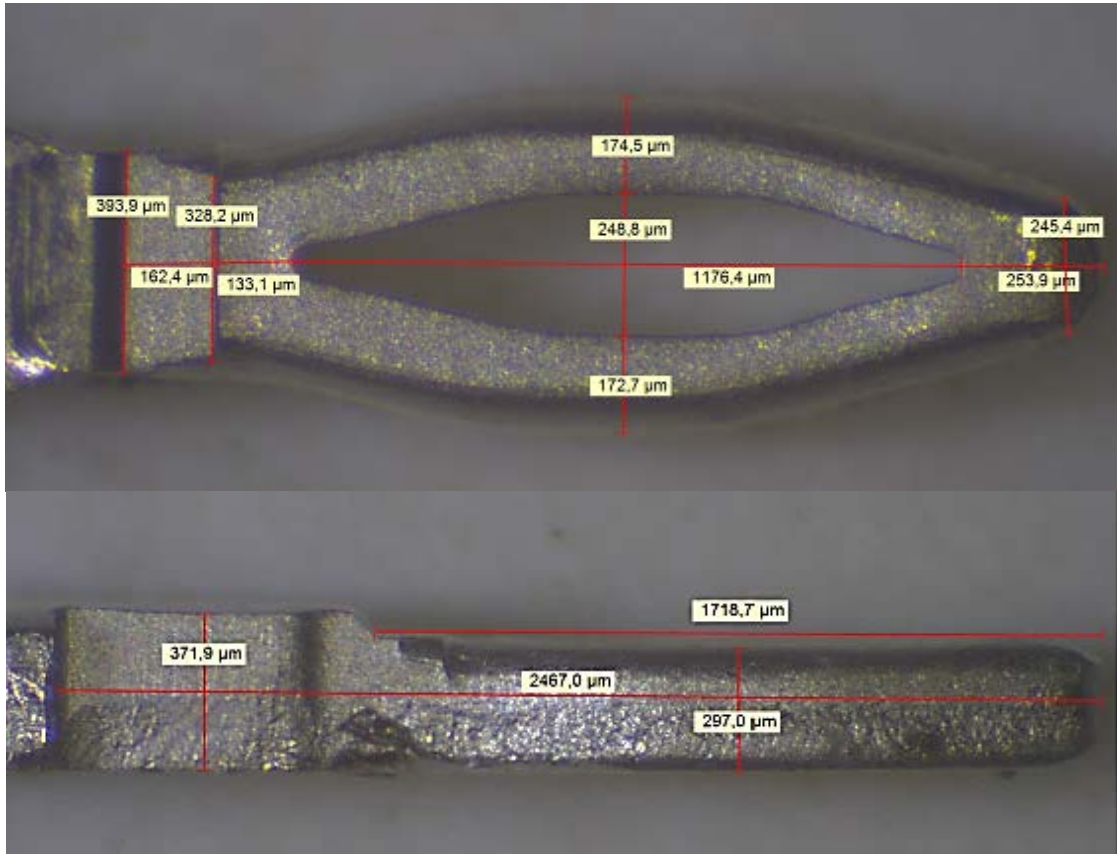

Figure 3 – Press fit signal pins for high speed connector A.

Measurements of ground pins for connector A are given in Figure4.

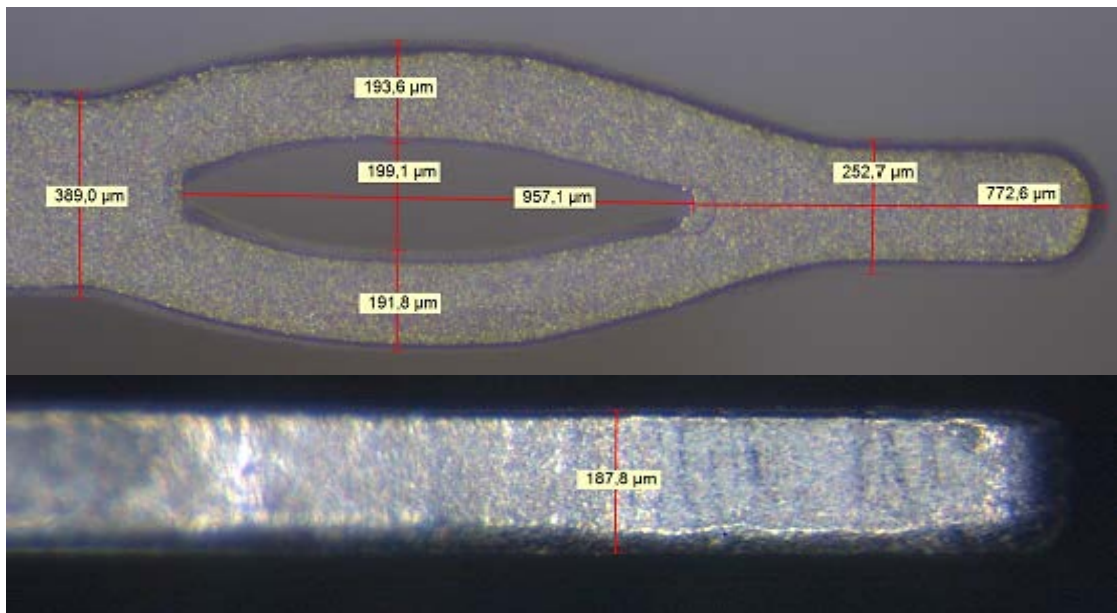

Figure 4 – Press fit ground pins for high speed connector A.

Figure 3 and Figure4 show that the signal pin material is thicker than the ground pin material. On the other hand, the needle eye opening is bigger for the signal pin than for the ground pin. The signal pin edges are also more rounded than the edges for the ground pins.

The pins consist of a bronze alloy plated with tin over nickel.

A.2–High Speed Press Fit Connector B

High speed press fit connector B has small signal pins made for 0.36 mm \pm 0.05 mm final hole diameters. The ground pins for this connector are much bigger than the signal pins and were not included in this evaluation.

A photo of the bottom side of the package showing the compliant press fit pins is given in figure 5.



Figure 5 – Press fit pins for high speed connector B.

As can be noted in Figure 5, every third pin is a ground pin and the sizes and shapes differ very much between the ground pins and the signal pins.

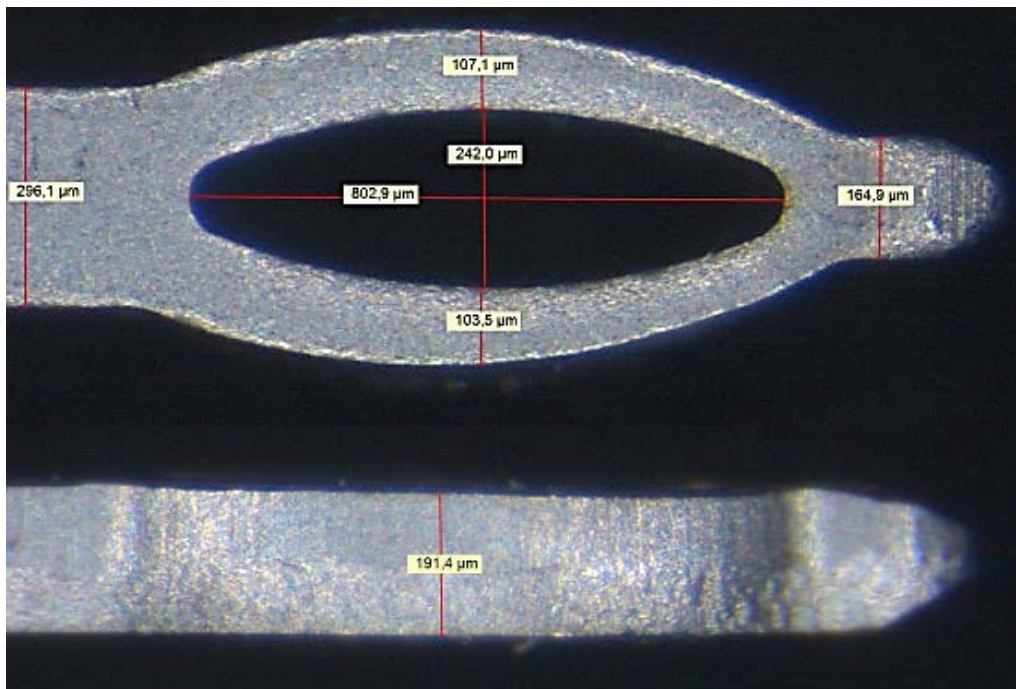

Figure 6 – Press fit signal pins for high speed connector B.

Figure 6 shows that the needle eyeopening on the signal pins for connector B is rather big and that the sides of the needle eye are thin.

The pins consist of copper plated with matte tin over nickel.

A.3–High Speed Press Fit Connector C

High speed press fit connector C has small signal and ground pins aimed for $0.36\text{ mm} \pm 0.05\text{ mm}$ final hole diameters. The ground pins and the signal pins have similar size and shape.

A photo of the bottom side of the package showing the compliant press fit pins is given in Figure 7.

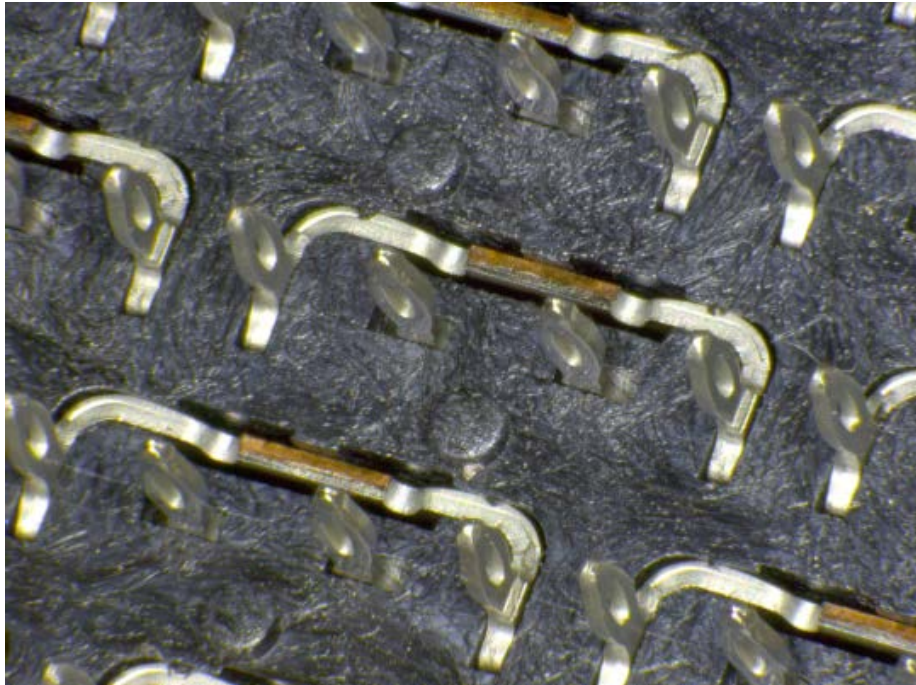

Figure 7 – Press fit pins for high speed connector C.

As can be seen in Figure 7, the ground pins and signal pins are turned 90° relative to each other.

Measurements of the signal pins for connector C are shown in Figure 8.

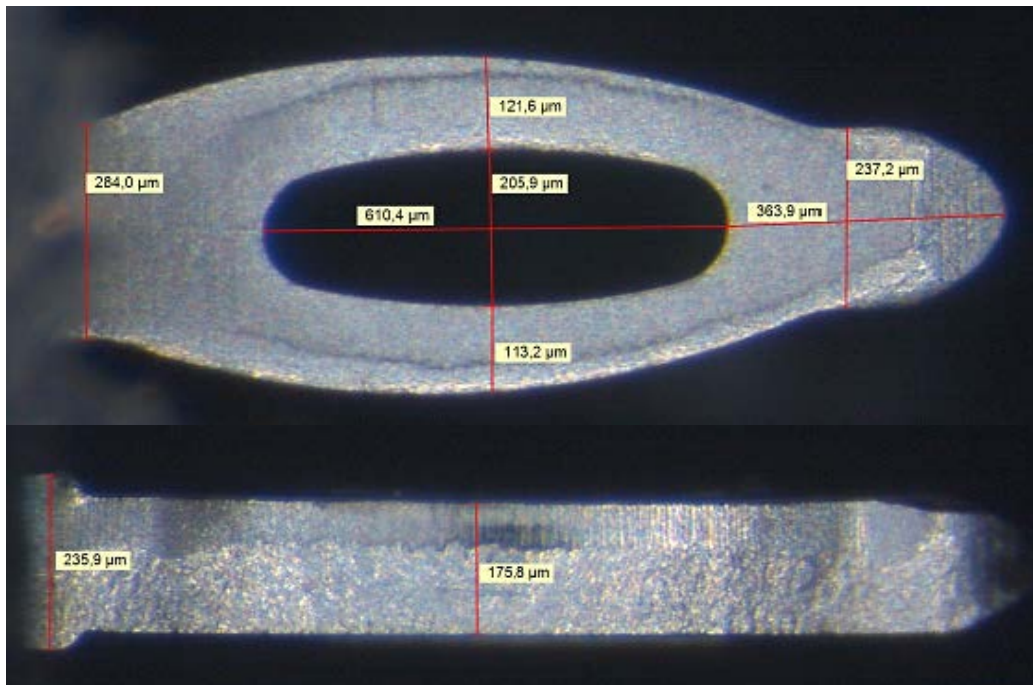

Figure 8 – Press fit signal pins for high speed connector C.

As can be seen in Figure 8, the needle eye is slightly smaller, both in length and width than the other components' pins and the material on the sides of the needle eye is also thin.

The pins are made of copper plated with nickel.

A.4-Reference Press Fit Connector D

The reference component is an old variant of a press fit connector that does not use needle eye pins. Instead, the pins consist of a solid tip followed by a thin metal foil that conforms to the hole wall when inserted. The pins on the reference connector D are much bigger than the new high speed connector pins that are evaluated in this study. Recommended final hole diameters for these pins are 1.00 mm $-0.0/+0.1$ mm.

A photo of the bottom side of the package showing the compliant press fit pins is given in Figure 9.

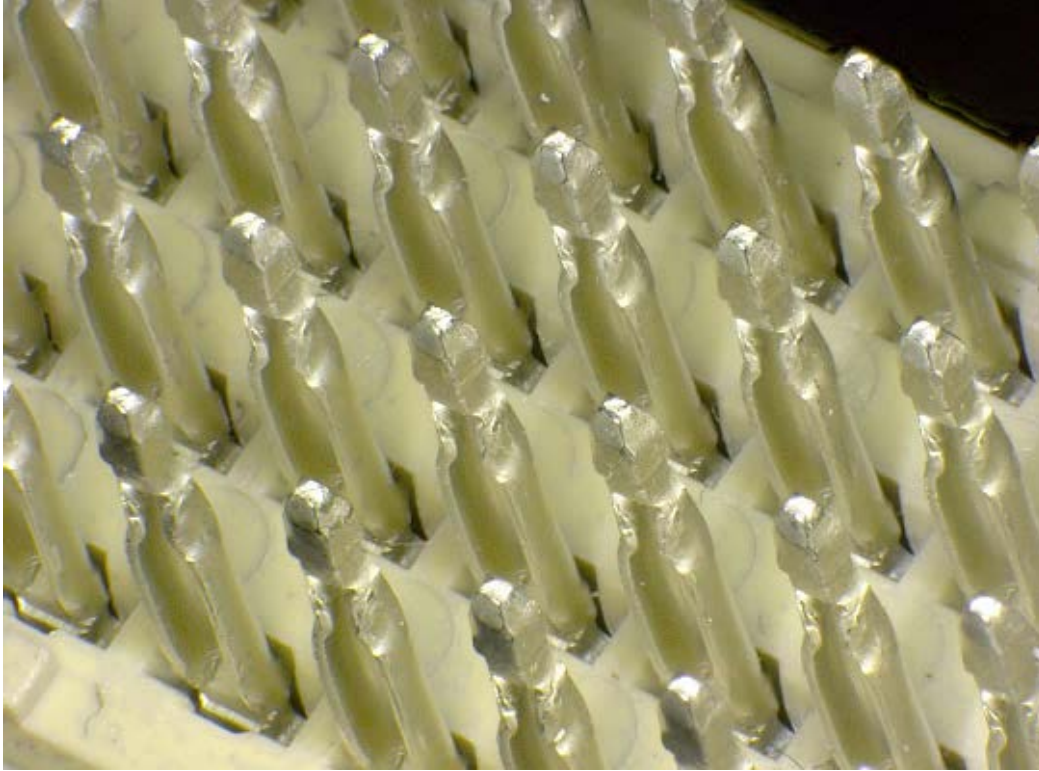

Figure 9 – Press fit pins for reference connector D.

Measurements of a compliant pin from reference connector D are shown in Figure 10.

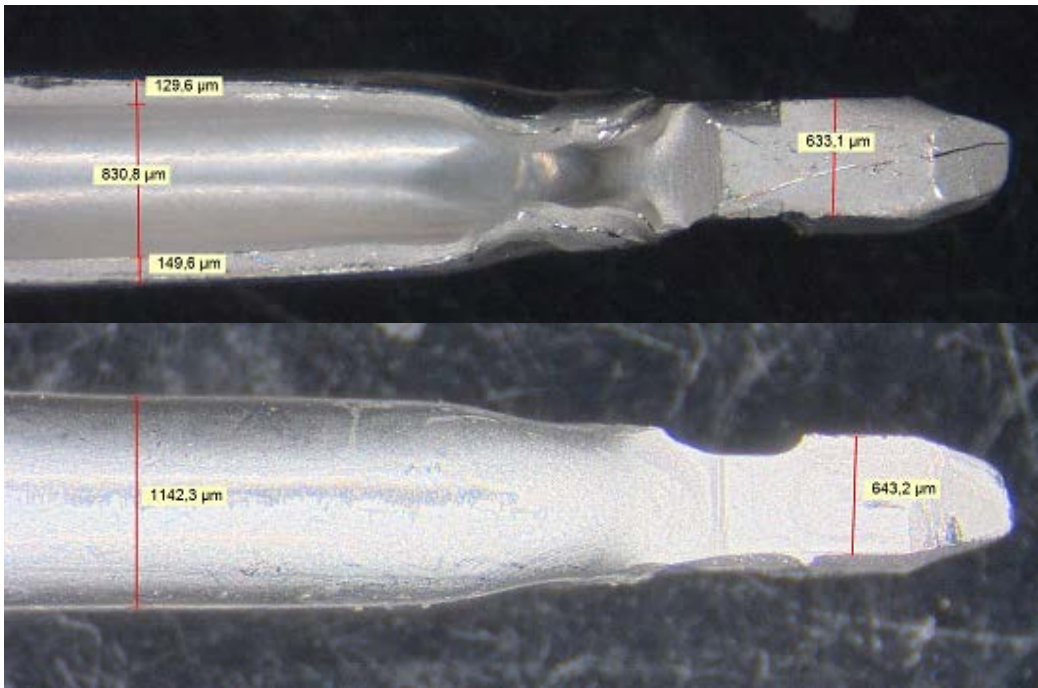

Figure 10 – Measurements of press fit pin for reference connector D.

Measurements of the solid tip of a press fit pin for the reference connector D is given in Figure 11.

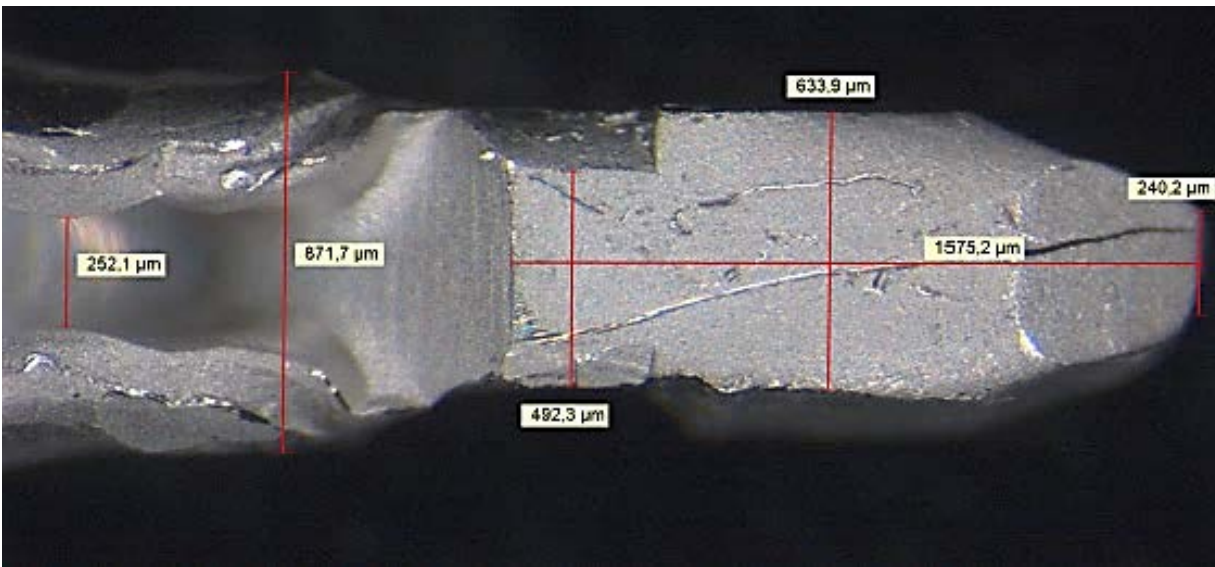

Figure 11 – Measurements of press fit pin for reference connector D.

As has already been mentioned, the compliant pins for the reference connector D are much bigger than the new high speed press fit connector pins and the connection technology differs as well. It is therefore, unfortunately, difficult to make fully justified comparisons between the reference connector and the other tested connectors.

The pins consist of a bronze alloy plated with nickel.

A.5–High Speed Press Fit Connector E

High speed press fit connector E has small signal and ground pins aimed for 0.36 ± 0.05 mm final hole diameters. The ground pins and the signal pins have similar size and shape.

A photo of the bottom side of the package showing the compliant press fit pins is given in Figure 12.



Figure 12 – Press fit pins for high speed connector E.

The ground pins and signal pins form a rather complicated pin pattern and they have slightly different geometries. Measurements of signal pins for connector E are shown in Figure 13.

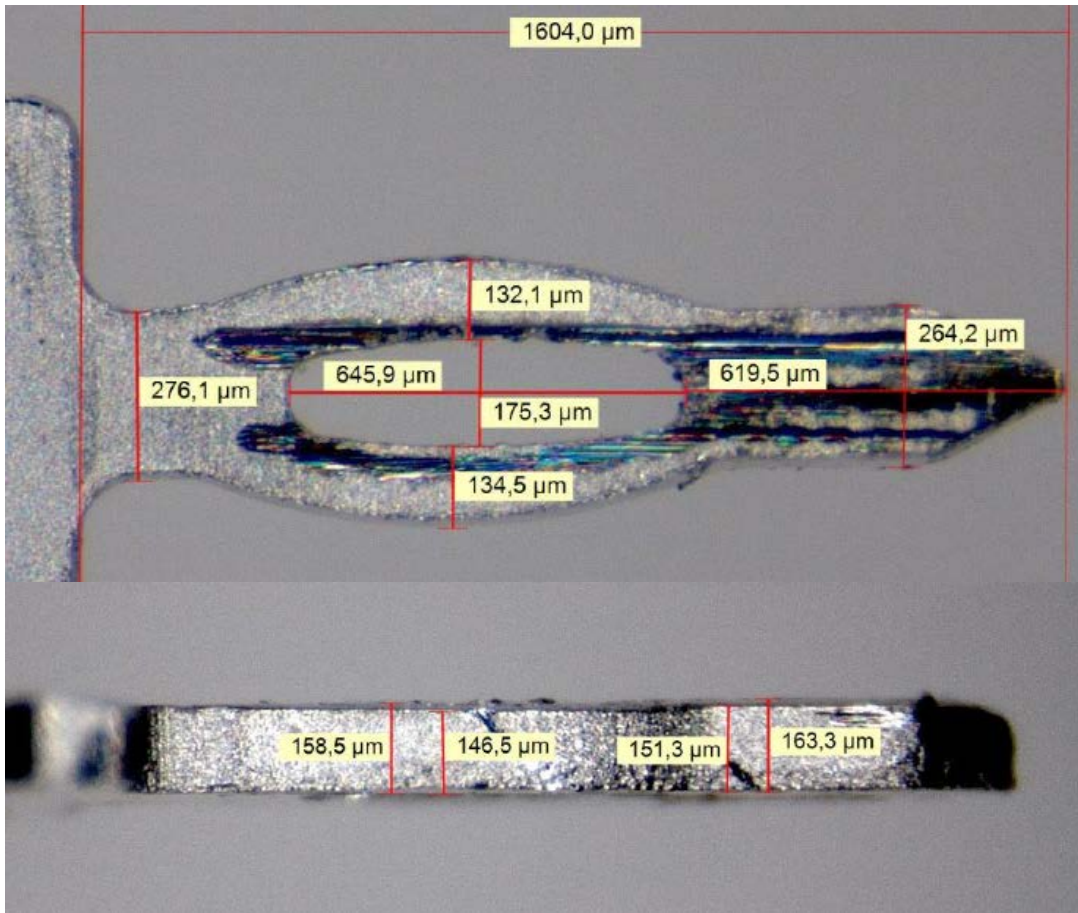

Figure 13 – Press fit signal pins for high speed connector E.

Measurements of ground pins for connector E are given in Figure 14.

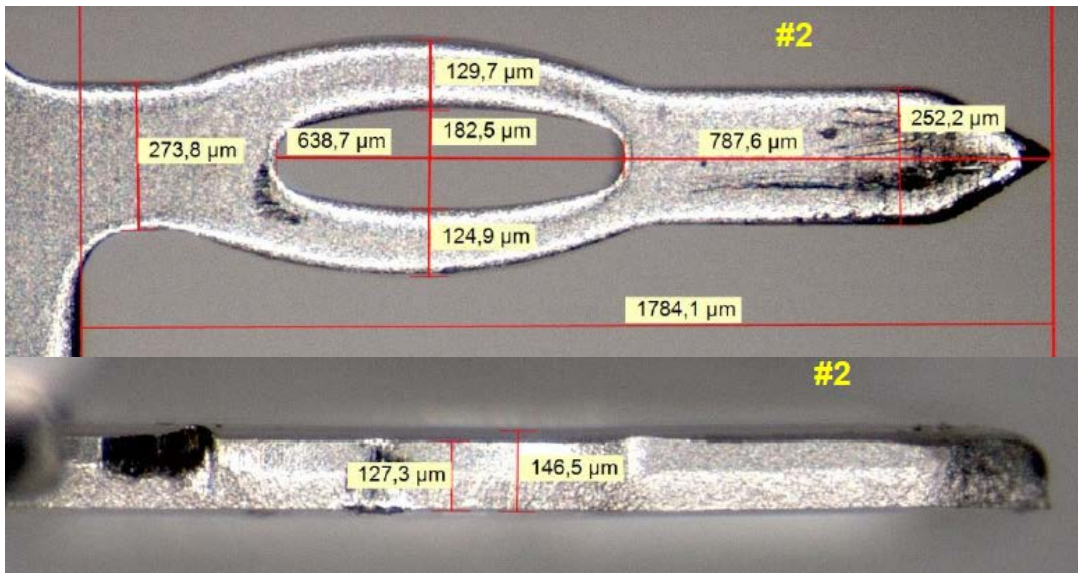

Figure 14 – Press fit ground pins for high speed connector E.

Figure 13 shows that the needle eye opening in the signal pins for connector E is rather small and that the sides of the needle eye are thick. The ground pins have slightly bigger needle eyes and thinner material at each eye side, which will make the insertion force lower.

The pins base material is copper which is plated with matte tin over nickel.

A.6–Summary of Pin Measurements

The compliant pin measurements are summarized in Table 1.

Table 1–Test connector pin measurements – summary (all measurements in μm).

	Connector A		Connector B		Connector C		Connector D	Connector E	
	Signal Pin	Ground Pin	Signal Pin	Ground Pin	Signal Pin	Ground Pin	Pin	Signal Pin	Ground Pin
Pin Thickness	297	188	192	185	176	141	579	155	142
Pin Width at Base	394	389	296	351	284	307	1142	276	264
Pin Width at Tip	245	253	165	367	237	252	634	264	257
Pin Width at Eye	596	584	453	655	441	444	1110	442	418
Eye Length	1176	957	803	961	610	595	NA	646	641
Eye Width	249	199	242	290	206	189	831	175	195
Material at each Eye Side	174	193	105	182	117	128	140	133	112

In this study, only signal pins have been used for the insertion and retention tests. For the gas tightness test and the cross sectioning, both signal pins and ground pins for the connectors A, C and E have been included.

B. Test Board

A special test board was designed for this press fit rework evaluation. It was decided that the final hole sizes should include each connector’s specified minimum, nominal and maximum diameters. These different hole sizes weremadeat each connector site.

A photo of one test board with ImSn hole plating and one test board with ENIG hole plating is given in Figure 15.

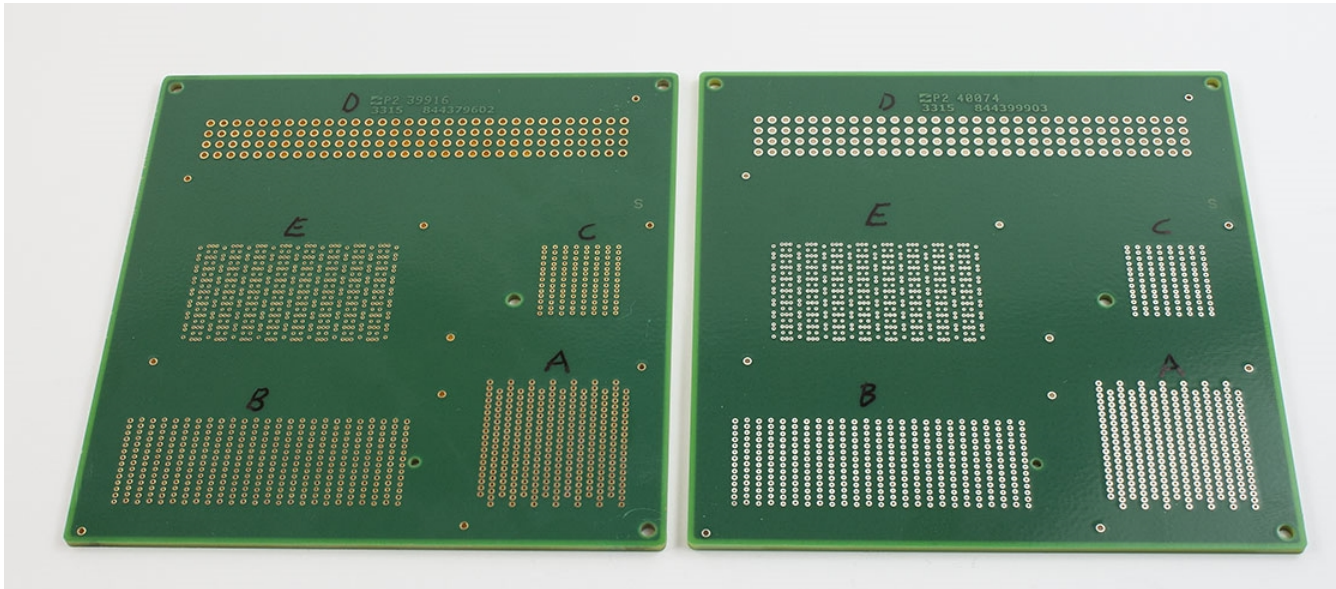

Figure 15 –Test boards – ENIG (left), ImSn (right). The different component sites are marked A to E.

Most of the design parameters for the test board were chosen to resemble those of a common base station or core network board. The board size was, however, much smaller in order for the board to fit into a gas tightness test chamber. The number of layers was also less than in an ordinary base station or core network board.

The board parameters are given in Table 2.

Table 2–Test board parameters.

Surface Metallization	ENIG or ImSn
Base Material	High Performance High Temperature Rated (T _g = 180°C) FR4
Hole Sizes	Min, Nom, Max (for each connector)
Number of Layers	6
Distances between layers [mm]	L1-L2: 0.1, L2-L3: 0.5, L3-L4: 0.6, L4-L5: 0.5, L5-L6: 0.1
Board Thickness [mm]	1.8
Outer Copper Layer Thickness [mm]	0.050 ±0.020
Inner Copper Layer Thickness [mm]	0.017 +0.003/-0.007
Full Ground Layers	L2 and L5
Board Size [mm]	100 x 100

The most difficult part to succeed in when manufacturing the test boards was to receive the specified minimum, nominal and maximum final hole diameters for each of the tested high speed press fit connectors. The specified final hole dimensions for the test pins for each of the connectors are given in Table 3.

Table 3–Test Board Parameters.

Connector	Final Hole Dimension [mm]
A	0.46 ±0.05
B	0.36 ±0.05
C	0.36 ±0.05
D	1.0 +0.1/-0.0
E	0.36 ±0.05

In order to be able to receive the correct minimum, nominal and maximum final hole size for each of the tested new high speed press fit connectors, the drill sizes shown in table 4 were used during the fabrication of the test boards³.

Table 4– Drill Sizes for the Different Sites on Test Board.

Connector	Min Hole Size Drill	Nom Hole Size Drill	Max Hole Size Drill
A	#75, 0.0210"(0.533mm)	0.55mm(0.02165")	#74, 0.0225"(0.572mm)
B	0.425mm (0.01673")	0.45mm(0.01771")	#77, 0.0180"(0.457mm)
C	0.425mm(0.01673")	0.45mm(0.01771")	#77, 0.0180"(0.457mm)
D	1.125mm (0.0433")	1.15mm(0.0453")	#56, 0.0465"(1.181mm)
E	0.425mm (0.01673")	0.45mm (0.01771")	#77, 0.0180" (0.457mm)

After the test boards had been produced, the final hole diameters were measured and one ImSn board and one ENIG plated board were cross sectioned to verify dimensions.

³ The drill sizes were suggested by David Wice, Ciena.

An example from a test board cross section of an ENIG plated hole intended for connector A is given in Figure 16.

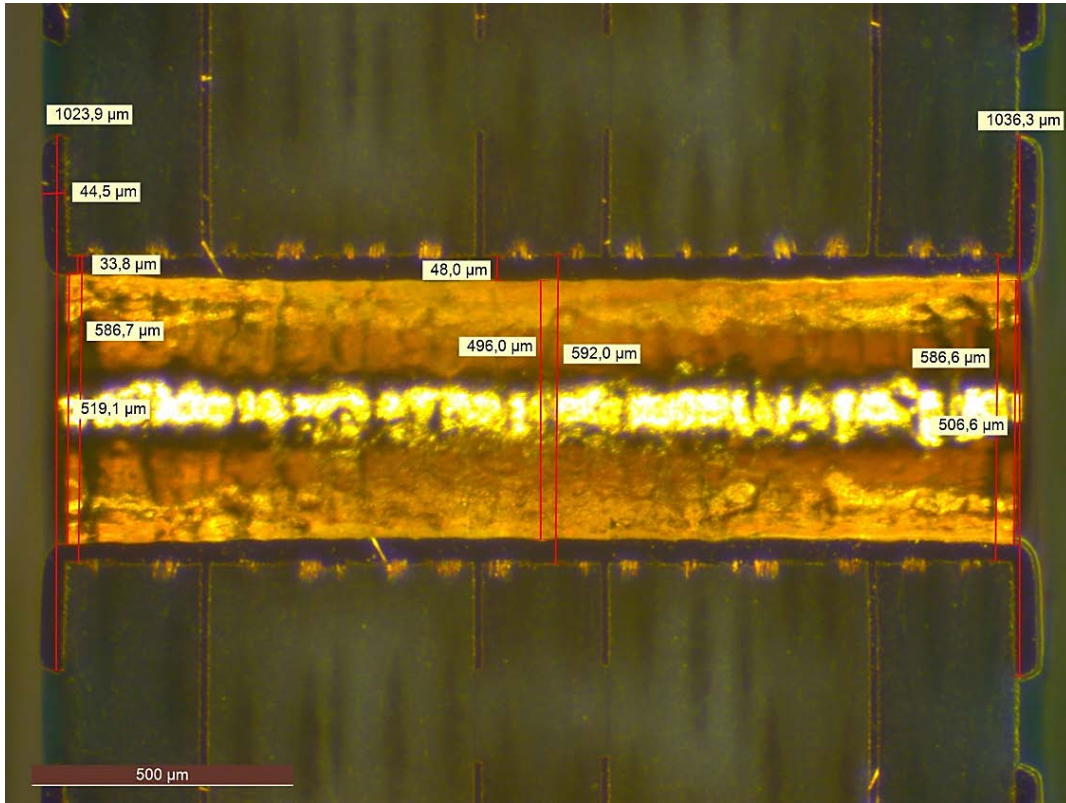

Figure 16 –Cross sectioning – ENIG board with hole for connector A.

An example from a test board cross section of an ImSn plated hole intended for connector A is given in Figure 17.

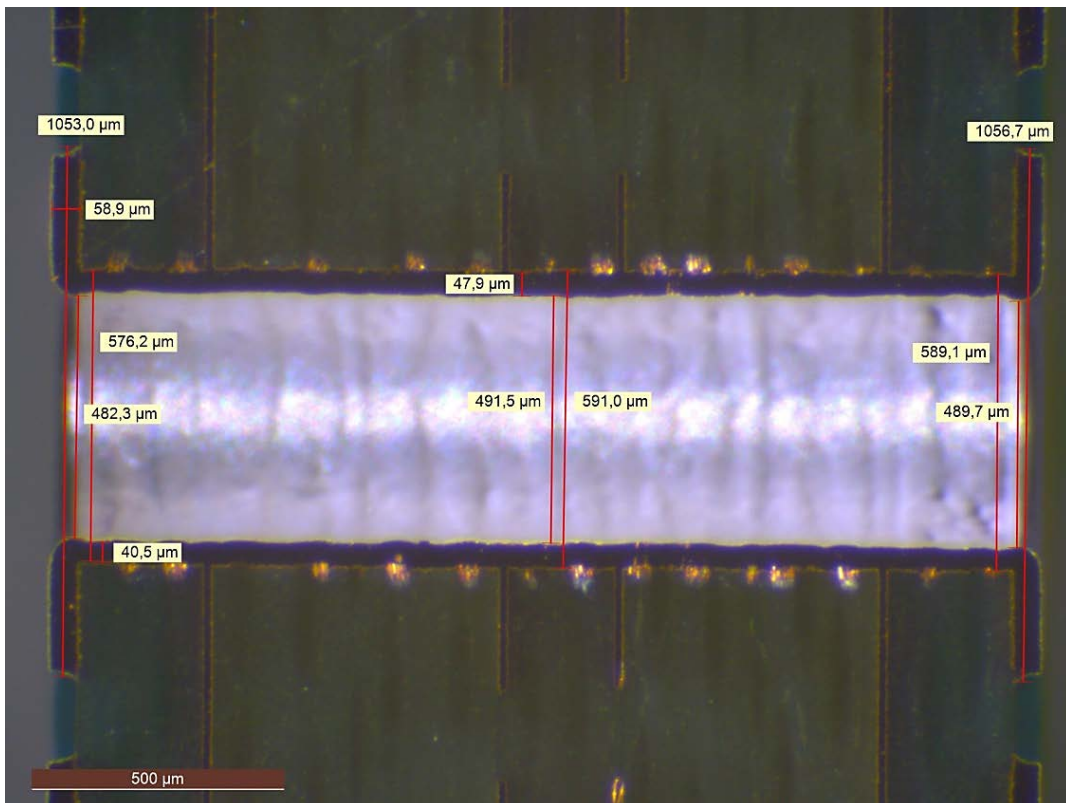

Figure 17 –Cross sectioning – ImSn board with hole for connector A.

The cross sectioning of two test boards (one ImSn and one ENIG) showed that they had been well fabricated. No test board failures could be found.

The holes were also measured using an optical measurement machine, see Figure 18.

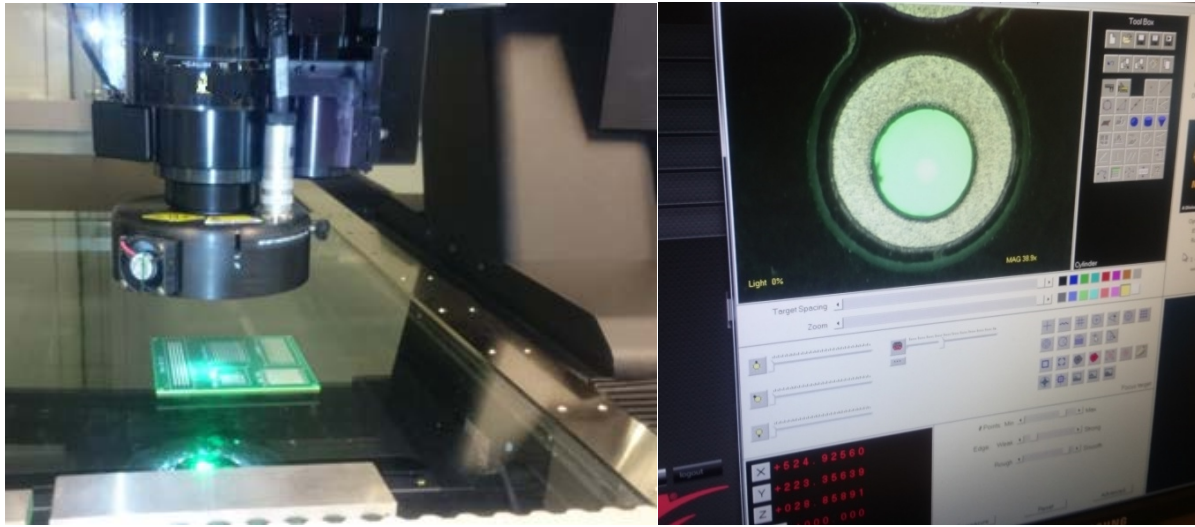

Figure 18 –Optical hole diameter measurements.

The measurements of the hole diameters gave the results shown in Table 5 and Table 6.

Table 5– Measured hole diameters – ENIG test board.

High Speed Connector	Average Min Hole Size [mm]	StD [mm]	Average Nom Hole Size [mm]	StD [mm]	Average Max Hole Size [mm]	StD [mm]
A	0.4825	0.0038	0.4825	0.0034	0.5073	0.0020
B	0.3578	0.0050	0.3874	0.0029	0.4014	0.0027
C	0.3529	0.0055	0.3839	0.0043	0.3971	0.0030
D	1.0544	0.0021	1.0822	0.0019	1.0994	0.0023
E	0.3347	0.0037	0.3631	0.0029	0.3830	0.0035

Table 6– Measured hole diameters – ImSn test board.

High Speed Connector	Average Min Hole Size [mm]	StD [mm]	Average Nom Hole Size [mm]	StD [mm]	Average Max Hole Size [mm]	StD [mm]
A	0.4651	0.0057	0.4652	0.0032	0.4845	0.0027
B	0.3425	0.0023	0.3704	0.0028	0.3960	0.0054
C	0.3405	0.0031	0.3708	0.0013	0.3983	0.0014
D	1.0367	0.0018	1.0645	0.0018	1.0699	0.0017
E	0.3295	0.0036	0.3507	0.0040	0.3764	0.0033

The hole measurements show that the ImSn plated holes have slightly smaller diameter compared to the ENIG holes. One observation is that both the minimum hole sizes and the maximum hole sizes have margins to the real specified limits. Another observation is that the drill for the A component’s minimum hole was so close to the nominal hole drill that the final hole diameters difference is negligible for these holes.

Apart from optical measurements, pin gauges have also been used for verification. A 0.45 mm diameter pin gauge could fit in all tested minimum and nominal holes for connector A, while a 0.50 mm diameter pin gauge could not fit.

The standard deviations from the hole measurements are low, so there are indeed three different hole sizes for each of the connector sites, except for connector A where there only are two.

As have been mentioned earlier, minimum, nominal and maximum hole diameters were designed for each connector site. Below are drawings of the hole patterns where the minimum holes are red, the nominal holes green and the maximum holes yellow (except for connector site B, where the colors are light green for the minimum holes, blue for nominal and lilac for the maximum hole size. The red, green and yellow holes for connector B are big ground pin holes that all have the same diameter on this test board).

The hole patterns can be seen in Figure 19 and Figure 20.

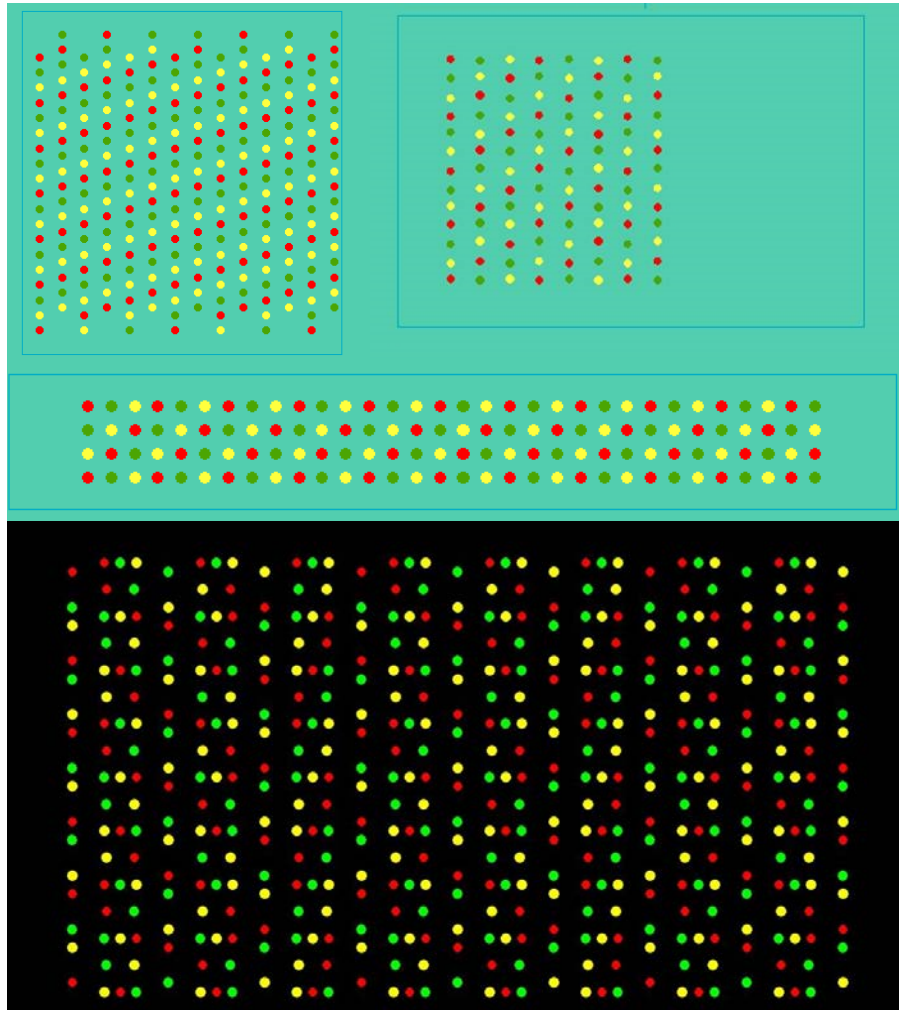

Figure 19 –Test board hole patterns for the connectors A (upper left), C (upper right), D (middle) and E (bottom).

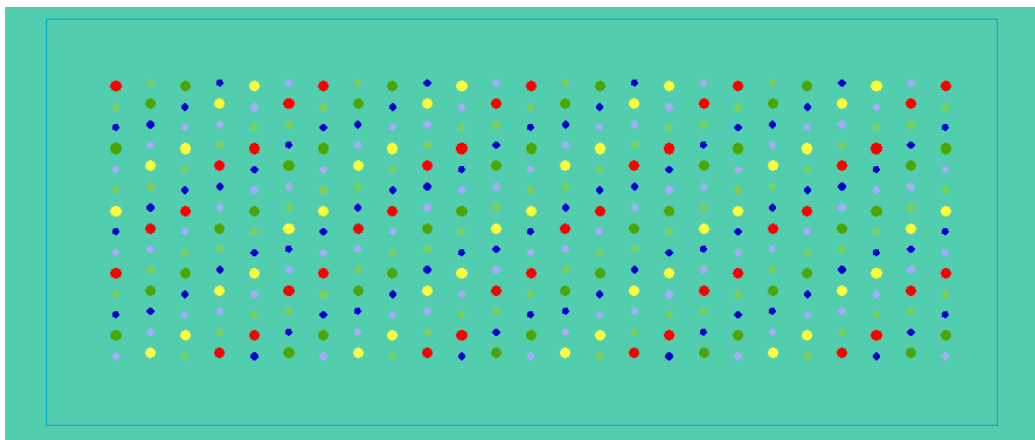

Figure 20 –Test board hole patterns for the connector B.

The test boards were judged as being well manufactured and suitable for the press fit rework evaluation.

IV. Press fit Rework

The demands and needs for removal and installation of each of the connectors were collected and when all instructions and tools had arrived, the rework was performed.

A. Press In

Adapted tooling for pressing in the different connectors into the board was needed. Examples of press in tooling are given in Figure 21.

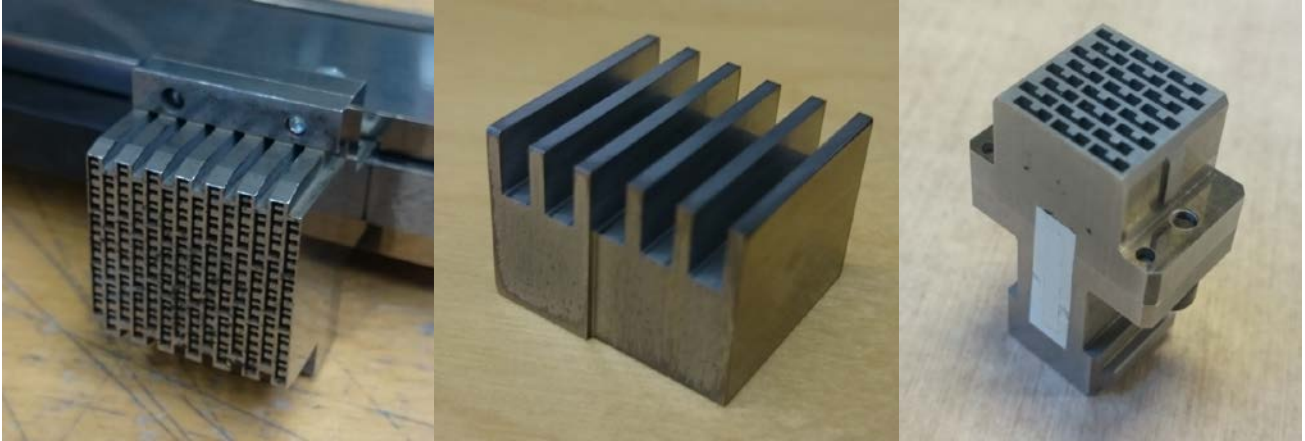

Figure 21 –Press in tooling intended for connector A (left), B (middle) and C (right).

Onesemi-automatic press in machine was used in the rework tests of the connectors A and D and another semi-automatic press in machine was used for the rework tests of the connectors B and C. In both equipment, the press in speed could be programmed and the force was measured during the whole press in process.

Figure 22 shows one of the semi-automatic press in machines while it is inserting connector B into one of the test boards. This very machine was used to press in the connectors B and C.

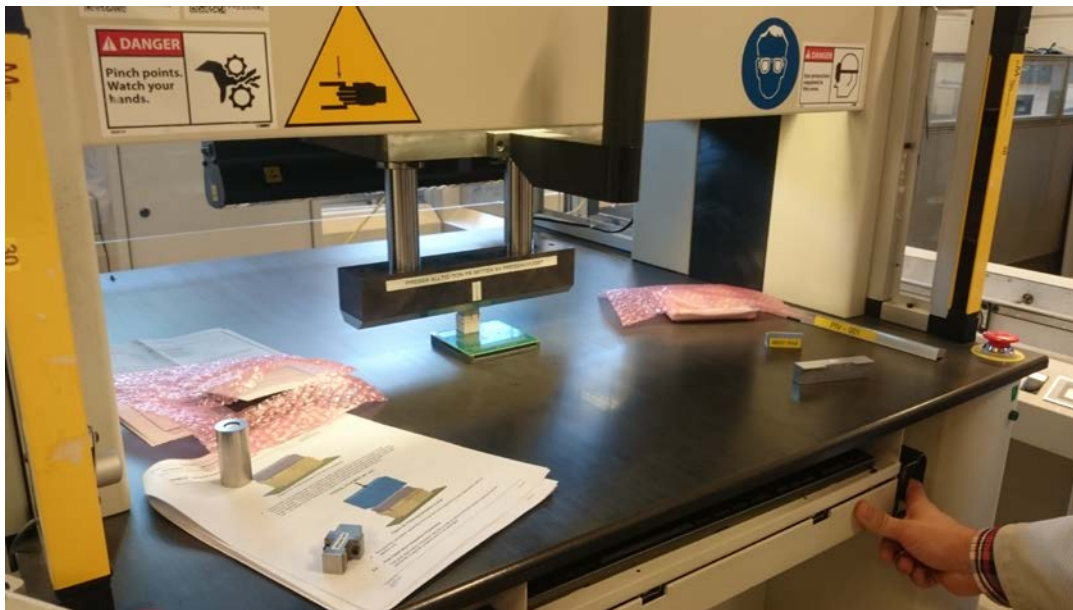

Figure 22 –Press in of connector B during the rework test.

The insertion force was measured during the press in process for each of the connectors in order to ensure that the maximum specified force was not exceeded for any of the A to D press fit connectors.

Typical examples of force graphs are given in Figure 23.

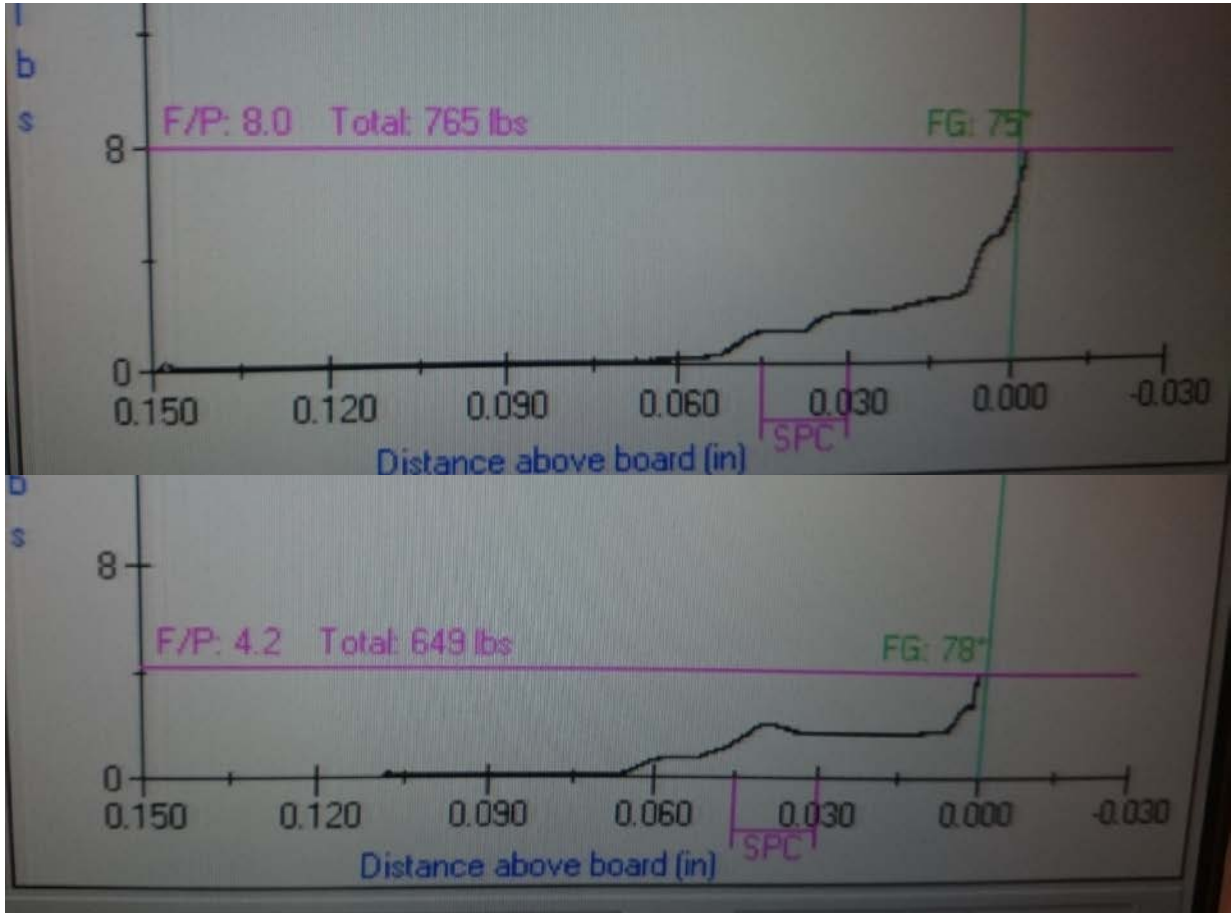

Figure 23 –Press in force graphs for connector B (top) and C (bottom).

A similar variant of press in equipment as for connector B and C was used to press in the connectors A and D. Figure 24 is showing two photos in which connector A and D respectively are being inserted with this equipment.



Figure 24 –Press in of the connector A(left) and D (right) during the rework test.

A typical graph from the press in of the high speed connector A is given in Figure 25.

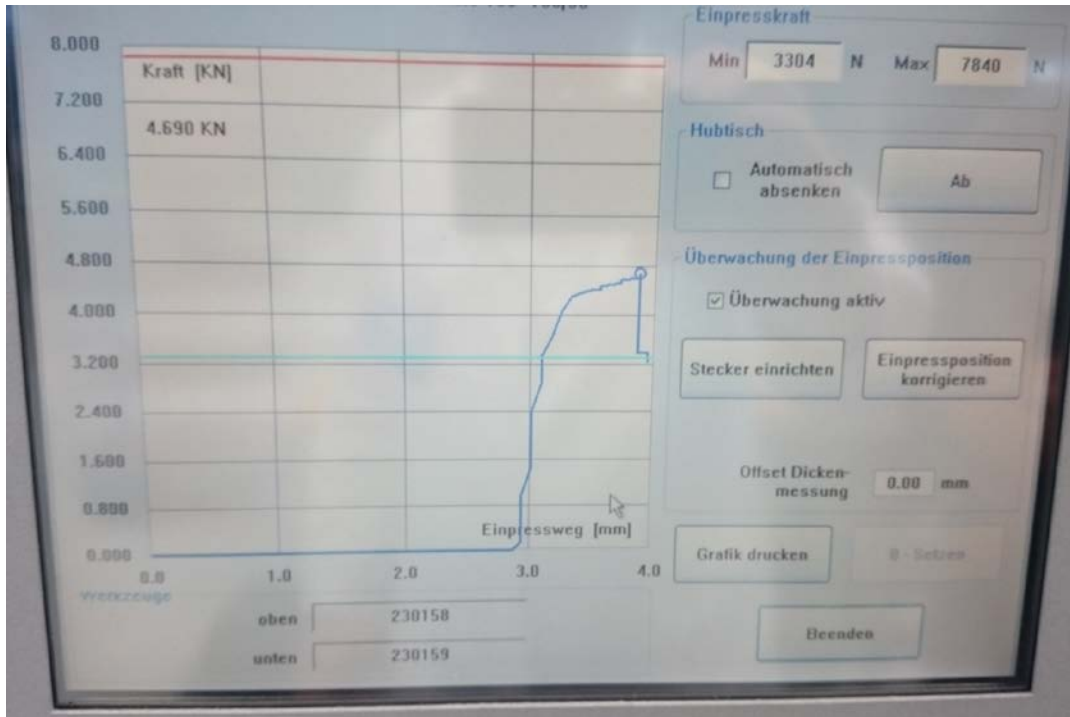

Figure 25 –Press in force graph for connector A.

The high speed connector E was reworked after the other four connectors and at the time of this rework, no semi-automatic press in machine was available. Because of this, a manual press in equipment was used. However, this machine was sensitive and of good quality which made it possible to press in the connectors smoothly and in a well-controlled manner.

A photo from the manual press in of high speed connector E during the rework tests is shown in Figure 26.



Figure 26 –Manual press in of connector E.

A closer look at connector E during press in is given in Figure 27.

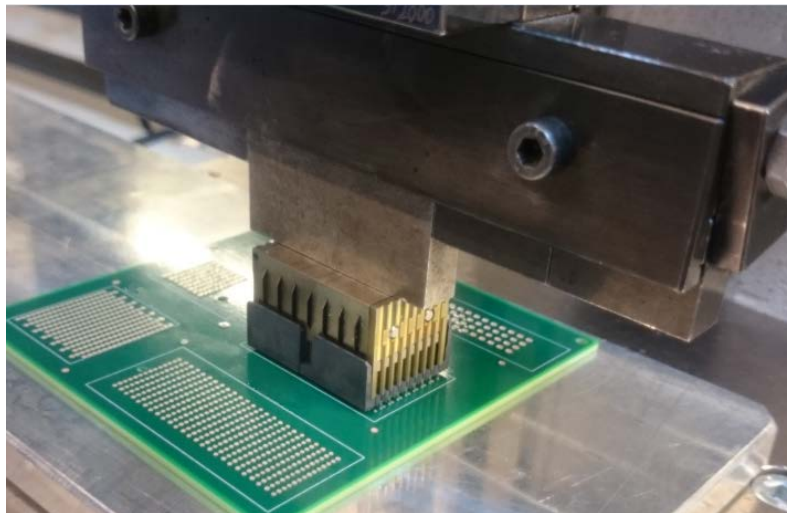

Figure 27 –Press in of connector E during the rework test.

As a summary; the press in processes that were used succeeded to press in the test connectors with the specified forces and times stated by the connector vendors.

B. Removal

The instructions, tooling and processes for removing the connectors recommended by the connector manufacturers were used during all the removals, except for high speed connector A since the specially adapted tool had not arrived in time for the test.

A description of the rework for each of the connectors is given in the sections below.

B.1–Removal of Connector A

Removal of the high speed press fit connector A could not be performed with the specially adapted tooling, with small pins aimed at pushing out the needle eye press fit connection pins, that first was planned to be used. This tooling was not available

at the time for the test. After consultation with the manufacturer of high speed connector A, it was decided to use a thin manual tool, resembling a bent screwdriver, to break up the press fit connections instead. The edge of the tool was placed under the outer part of the connector body and then the package was lifted by smoothly bending the tool. The tool was moved around all the package sides during the removal process.

A photo of the removal of connector A is shown in Figure 28.



Figure 28 –Removal of connector A.

The plated holes were inspected after the removal and some holes had, unfortunately, been visibly damaged during the removal process. These holes were situated at the outer hole-rows. However, the inner-row holes and most of the holes in the periphery seemed to be undamaged.

B.2-Removal of Connector B

For the removal of connector B, a specially adapted tooling was used with multiple thin pins made to push the press fit pins out of the holes from below. In the first trials, the force needed to press out the connector was so high that the board bent too much. In order to avoid this, another test-round was performed where a board support was used. This made it possible to remove the connector without bending the board.

Two photos from the removal process of the connector B are shown in Figure 29.

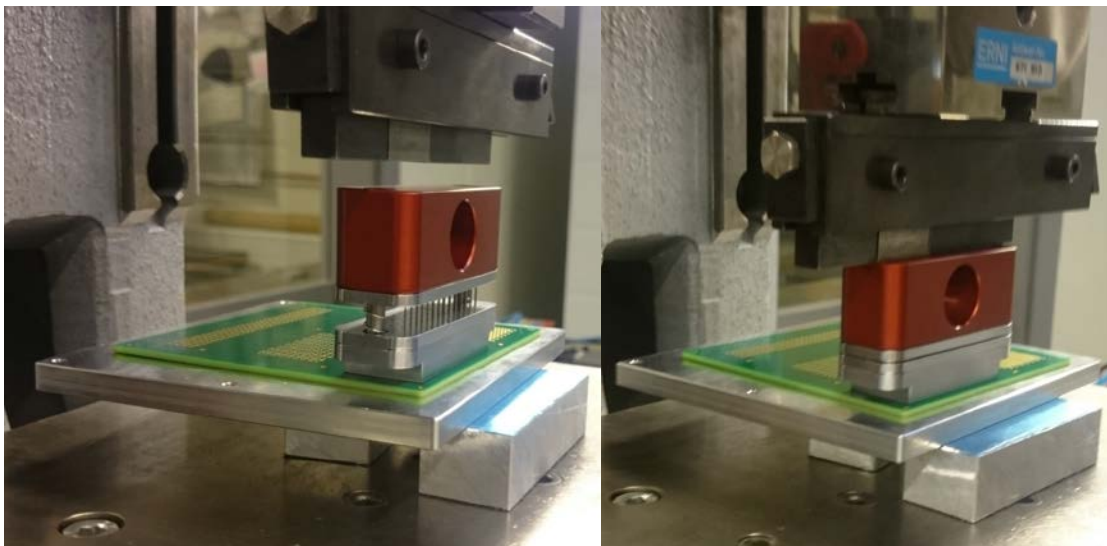

Figure 29 –Removal of connector B with specially adapted tooling and board support.

The removal process for connector B, following the manufacturer's recommendations, functioned very well.

B.3 – Removal of Connector C

The recommended method to remove connector C was to remove pin after pin and shield after shield with a pair of tweezers. This was performed without too much effort.

Two photos from the removal of connector C are shown in Figure 30.

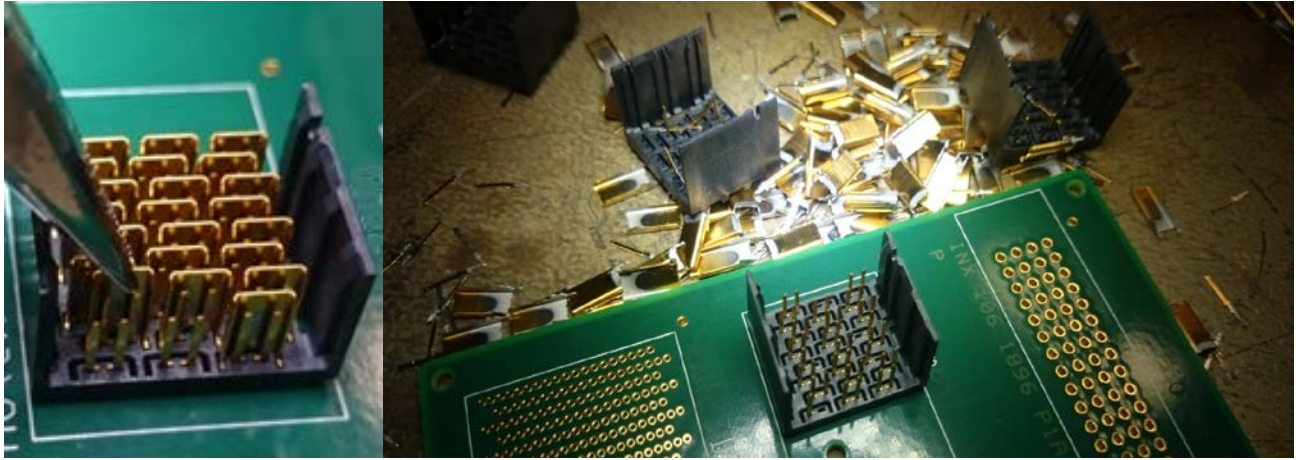

Figure 30 – Removal of connector C.

Everything worked out well during the removal of connector C.

B.4 –Removal of Connector D

For the reference connector D, a flat rock tool was sufficient in order to remove the connector. This was the only of the tested connectors with leads that protruded on the secondary side so it was easy to use the tips of the pins to push them out from the holes.

A photo of the removal of reference connector D is shown in Figure 31.

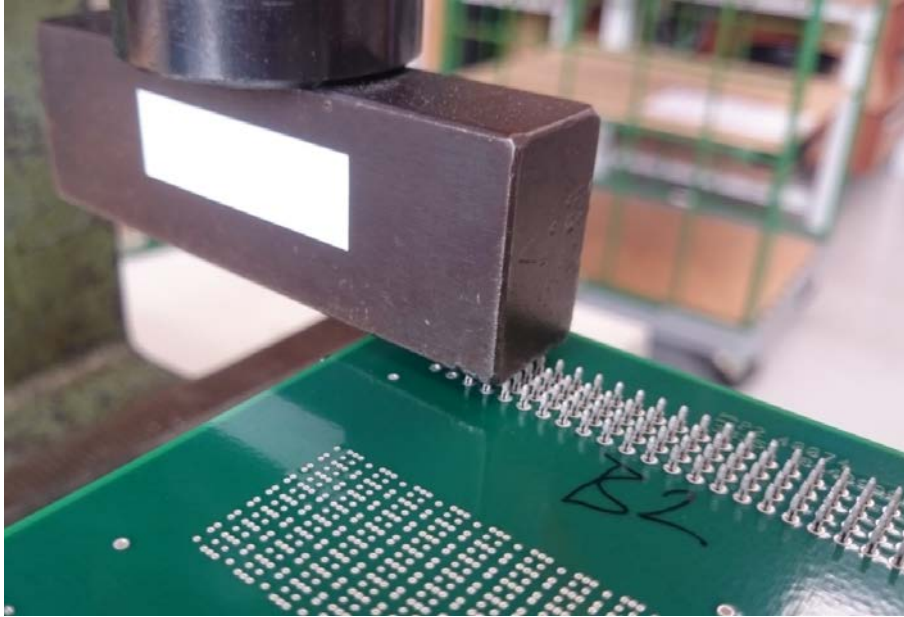

Figure 31 –Removal of connector D.

Everything worked perfectly well when removing the reference connector D.

B.5 –Removal of Connector E

For the removal of connector E, special tooling was used. The removal tooling consisted of five parts that are needed to be assembled on and around the connector that should be removed. The tooling is designed so that one part of it grasps under the edges of bottom part of the connector body and lifts the connector when turning a screw knob.

The different parts of the removal tooling for connector E are shown in Figure 32.

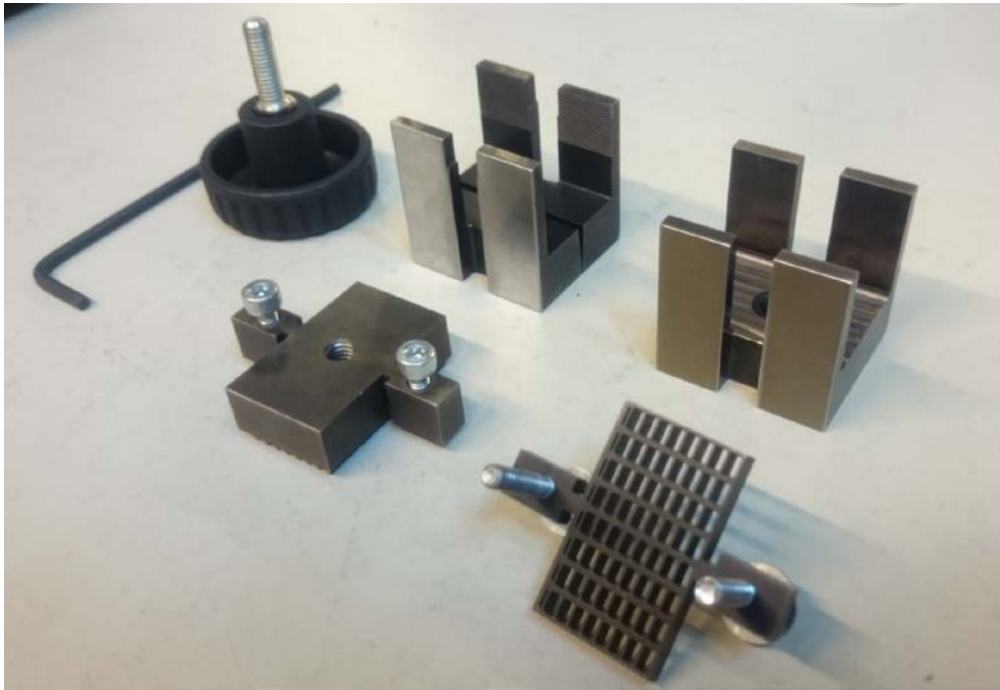

Figure 32 –Tooling for removal of connector E.

A connector that is about to be removed is shown in Figure 33.

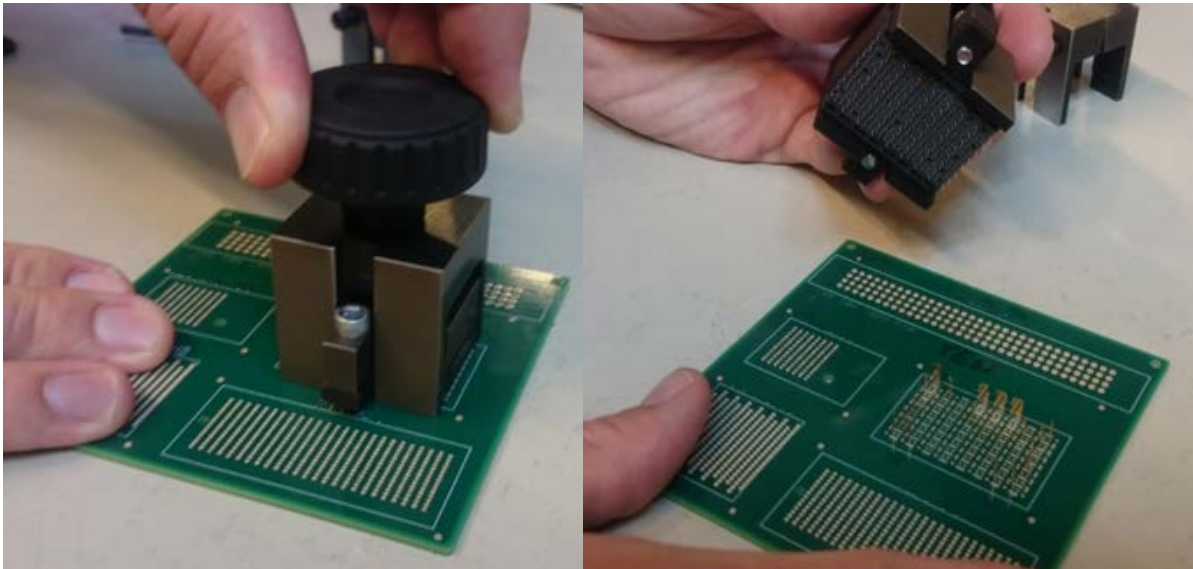

Figure 33 –Removal of connector E.

After removal of the connector package body and most of the pins, the remaining pins had to be removed with a pair of pincers.

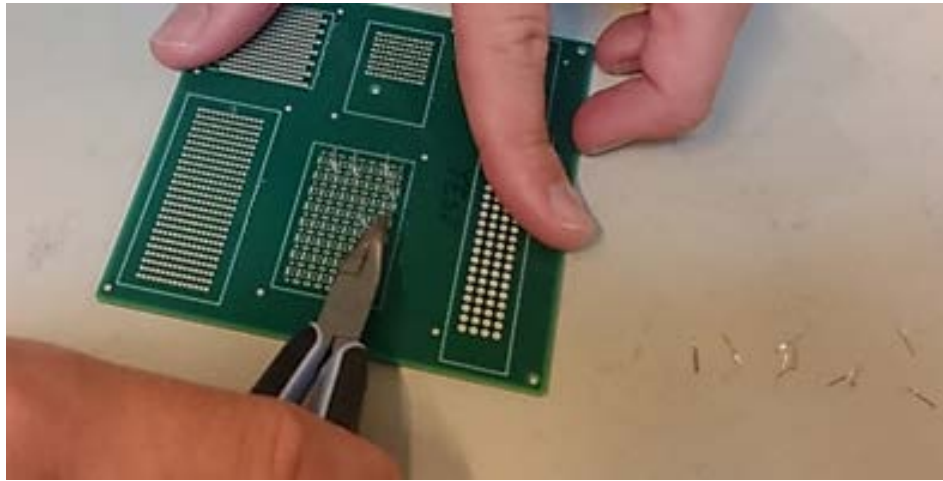

Figure 34 –Removal of remaining pins on connector E.

This was a gentle, but somehow tedious, way of removing a connector. No problems at all were found during the removal of connector E.

C. Summary of the Connector Rework

The rework was performed in a correct way according to the connector manufacturers' specifications (except for connector A). The insertions did not pose any problems at all, while the removal was performed in many different ways and was found to be more complicated. The questionable removal process for connector A was performed at the site and company where the connector was manufactured with personnel from this site and in a rather gentle way.

Altogether, the rework of these connectors was performed in ways that reflect how the connectors would be reworked on real products.

V. Tests and test results

After being reworked zero, once, twice or three times, the test boards were either sent to gas tightness test, which then was followed by cross sectioning or to insertion and retention test.

For the boards that were sent to gas tightness test and cross sectioning, the last inserted connectors remained on the board. The rework flow for these boards is shown in Figure 35.

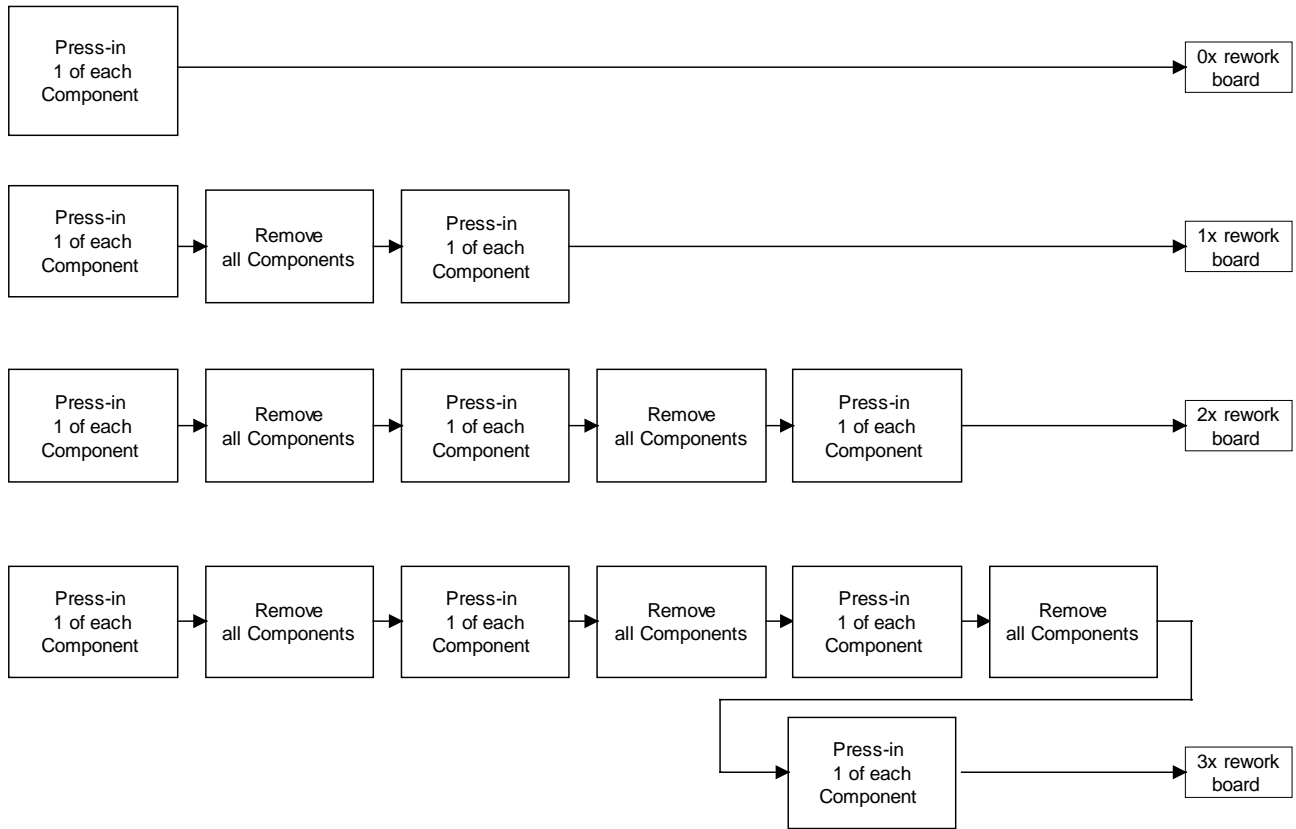

Figure 35 –Rework flow chart for connectors on boards intended for gas tightness test and cross sectioning.

For boards that were aimed at single pin insertion and retention force tests, the following rework process flow was used instead.

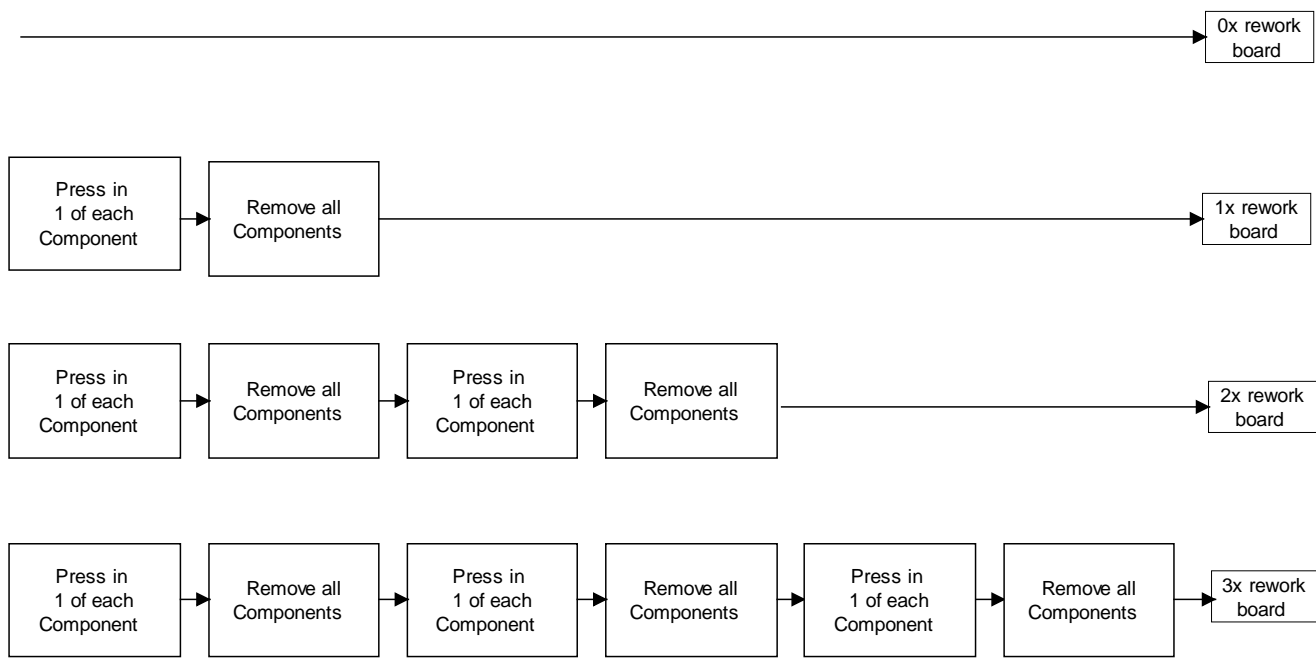

Figure 36 –Rework flow chart for connectors on boards intended for insertion and retention force tests.

All the boards from the extra rework run for connector B (because of too much board warpage during the main rework test) are shown in Figure 37.



Figure 37 –Boards where connector B had been reworked 0 to 3 times ready to be sent to gas tightness test followed by cross sectioning (boards with connector B) and to insertion and retention test (boards with no connector).

The boards with no connector (marked G0, G1, G2, G3 and H0, H1, H2, H3) were made for insertion and retention tests while the boards with connector B (marked E0, E1, E2, E3 and F0, F1, F2, F3) were made for gas tightness tests and cross sectioning.

The different tests and measurements performed after the rework and their results are described in the sections below.

A. Single Pin Insertion and Retention Force Measurements

In order to evaluate how the strengths of the press fit connections are affected by multiple reworks for the tested connectors, single pin insertion forces and retention forces have been measured⁴. The insertion and retention tests followed the standard Telcordia GR-1217-CORE [1].

Single pins were vertically inserted and then pulled out from the plated holes in the test boards. The maximum insertion and extraction forces were then noted for each combination of pin, hole size and hole plating.

⁴The insertion and retention tests in this study have been performed by Dennis Willie, Francoise Sarrazin, Kelvin Wong, Jie Lian, Christian Biederman, Wesley Tran and Christopher Vu at Flex in Milpitas, CA, USA. All data and images from the insertion and retention tests in this report have been created by them.

An example of a force versus displacement plot from the insertion and retention test is given in Figure 38.

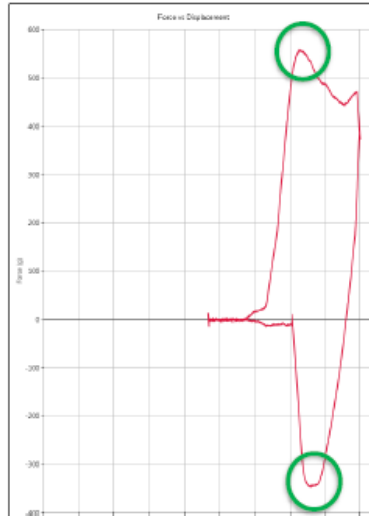

Figure 38 –Force versus displacement plot.

The maximum force in figure 38 is the insertion force and the minimum force is the extraction force. Both forces were recorded for analysis.

A.1–Test Material

The insertion and retention test was performed with single pins from each connector. Photos of these single pins are shown in Figure39.

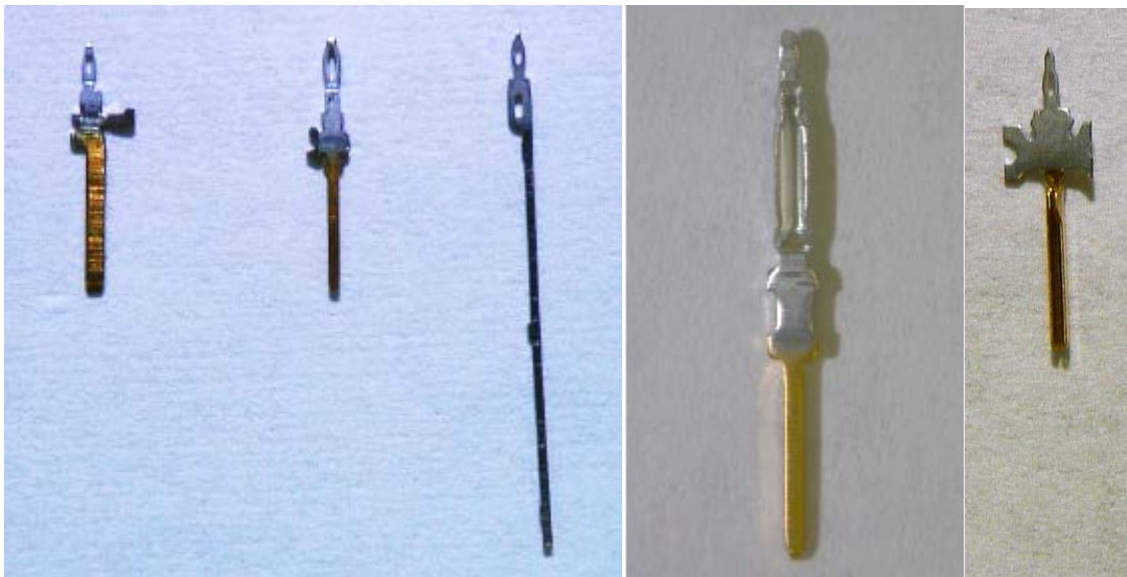

Figure 39 –Single pins for insertion and retention test C, A, B, D and E (from left to right).

240 pins of each pin type were used in this test, which gives 40 pins for insertion and retention for each combination of hole plating (ImSn and ENIG) and hole size (min, nom, max).

A.2–Equipment

A pull/shear tester with the ability to push or pull 490 N was used in the insertion and retention test, see Figure 40.

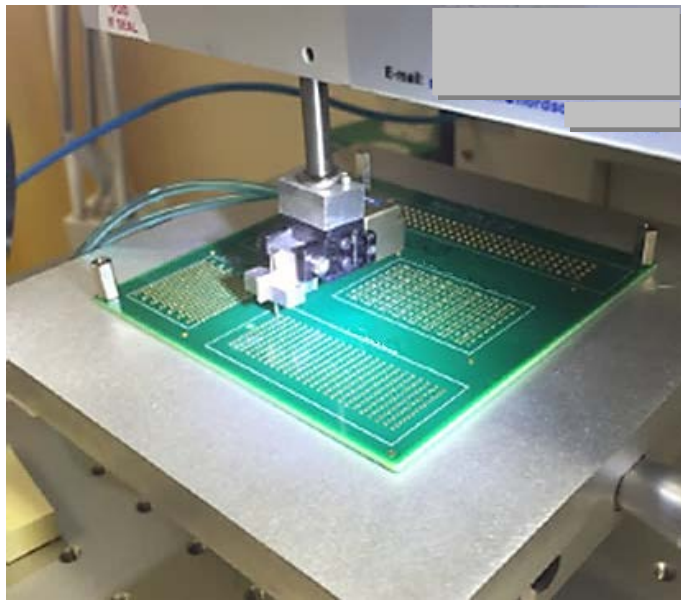

Figure 40 –Equipment for insertion and retention test.

A.3–Process

During the insertion and retention test, the pins were first aligned to the center of the holes and then inserted 1.4 mm with the insertion speed 100 mm/s. The hold time between insertion and retention was 3 s and then the pins were pulled out with the speed 100 mm/s.

All measured insertion and retention forces were saved for analysis.

A pin centered over a hole seen in the machine’s vision system just before insertion is shown in Figure 41.



Figure 41 –Vision system used to align pin to center of hole.

The insertion and retention of the single pins were performed according to the specification without any problems.

A.4 –Design of Experiment

A Design of Experiment (DoE) was performed that included 5 different factors with 2 up to 5 levels each, see Table 7.

Table 7– Factors and levels for the insertion and retention tests.

Board Finish	Amount of Rework	Pin Type	Hole Size	Force Type
ImSn	0	A	Maximum	Insertion
ENIG	1	B	Nominal	Retention
-	2	C	Minimum	-
-	3	D	-	-
-	-	E	-	-

A.5 –Results from Insertion Test

For the insertion force; the model created from the DoE explains the data very well (R-sq = 96.4%).

Interaction plots for the insertion force for the new high speed connectors A, B, C and E are given in figure 42. The data from the reference connector D is much bigger and will be discussed separately, see A.7.

In the Figures 42 to 46, the connectors A, B, C, D and E are called vendor 1, vendor 2, vendor 3, vendor 4 and vendor 5.

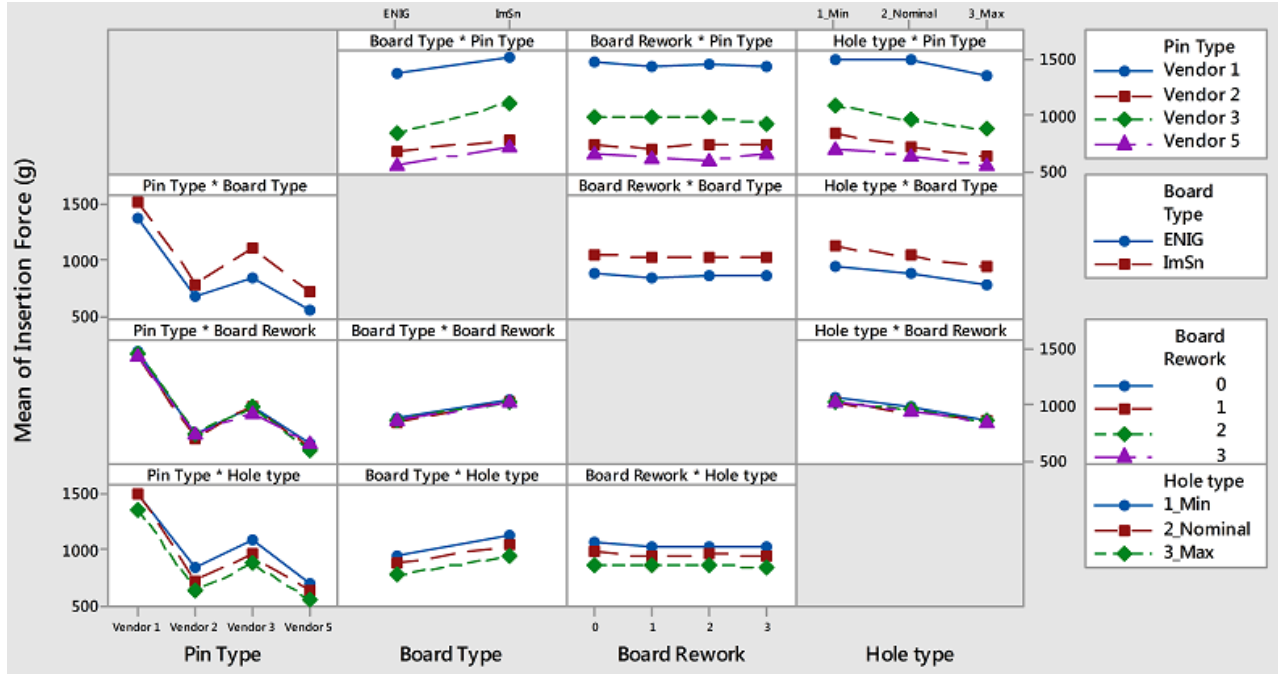

Figure 42 –Interaction plot for insertion force – fitted means (vendor 1 = A, vendor 2 = B, vendor 3 = C and vendor 5 = E).

As can be seen in the interaction plot for the insertion force, connector A has the highest insertion force followed by connector C, connector B and connector E. The insertion force is higher for ImSn compared to ENIG for all four connectors and the insertion force is higher for the smallest holes, lower for nominal holes and lowest for the biggest hole sizes. None of these results are surprising when taking into account the different pin sizes and geometries and also the fact that the PCB hole diameters are slightly bigger for the ENIG holes compared to the ImSn holes.

The most interesting results in the insertion test was that there was no significant difference in insertion force when pressing in pins into holes where 0, 1, 2 or 3 reworks previously had been performed. This indicates that the hole damage during rework is small.

The main effects from the insertion test are plotted in Figure 43.

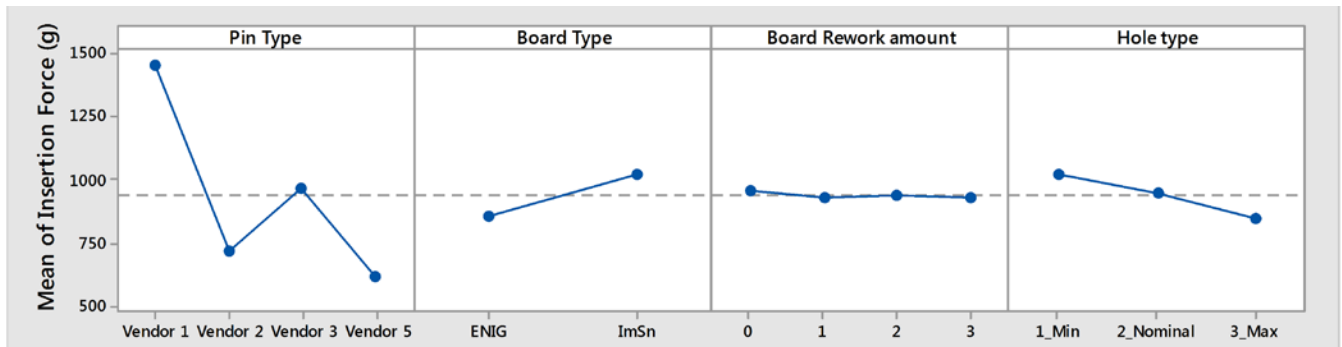

Figure 43 –Main effect plot for insertion force - fitted means (vendor 1 = A, vendor 2 = B, vendor 3 = C and vendor 5 = E).

A full nested ANOVA analysis from the insertion force tests shows that about 84% of the variance in insertion force are due to pin type (from connector A, B, C or E), 9% are from board type (ImSn or ENIG), 4% are due to hole type (min, nom, max), 3% are due to error and 0% (!) are due to amount of board rework (0,1,2 or 3 times).

A.6 –Results from Retention Test

The same analysis as for the insertion test was also performed for the retention test data and the interaction plot for the retention test of connector A, B, C and E is given below.

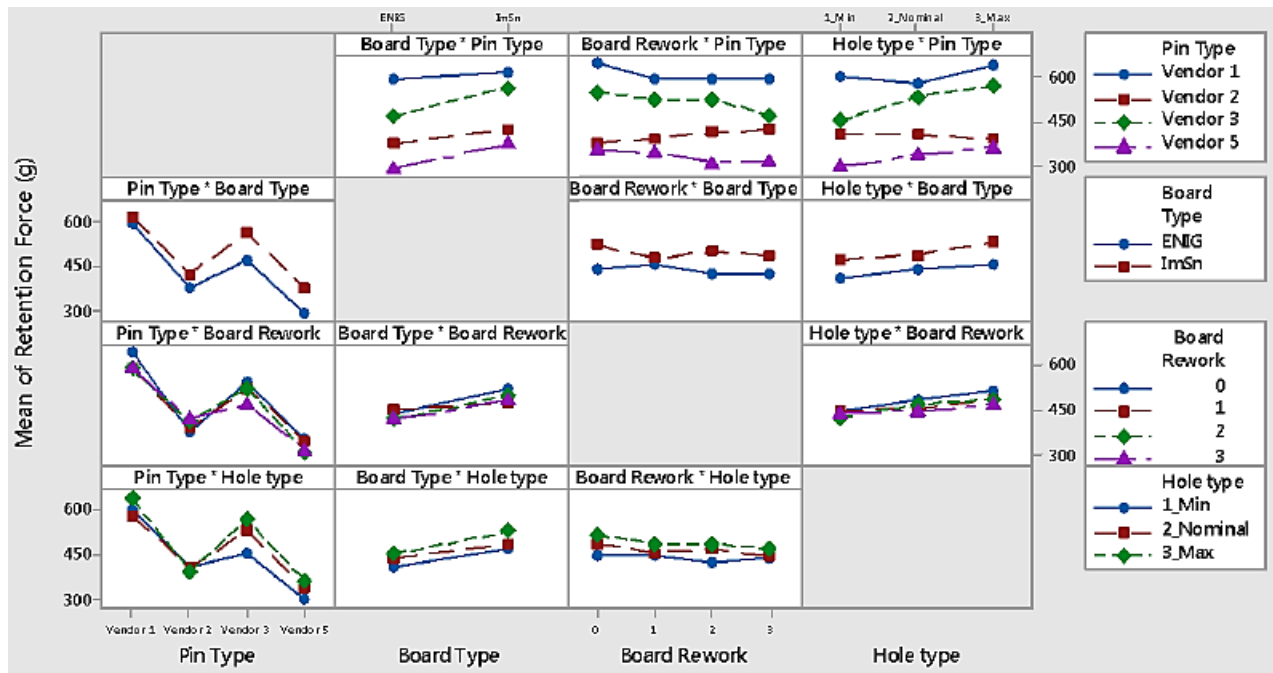

Figure 44 –Interaction plot for retention force – fitted means (vendor 1 = A, vendor 2 = B, vendor 3 = C and vendor 5 = E).

The retention force measurements show the same relationship between pin type and hole plating as for the insertion force measurements (pins from connector A need highest force to be pulled out followed by pin C, pin B and pin E. ImSn holes require higher retention force than ENIG holes do). The amount of rework does not affect the retention force much.

The difference between the insertion and the retention test is, first of all, that the force to pull out the pins are much lower than the force needed to press them in. Another interesting result from the retention test is how the hole sizes affect the retention force. At least for connector A, C and E, the retention force is higher for the bigger holes than for the smaller ones. This indicates that there could be permanent pin deformation during the pin insertion in the smallest holes that make the connection weaker.

The main effects from the retention test are plotted in Figure 45.

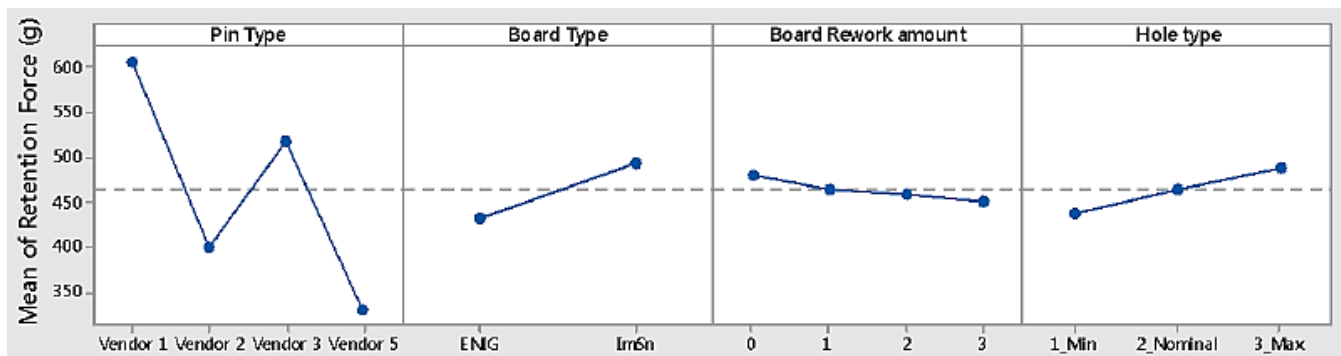

Figure 45 –Main effect plot for retention force – fitted means (vendor 1 = A, vendor 2 = B, vendor 3 = C and vendor 5 = E).

A full nested ANOVA analysis from the retention force tests shows that about 60% of the variance in retention force are due to pin type (connector A, B or C), 21% are due to error (!), 7% are due to hole type (min, nom, max), and 7% are due to board type (ImSn or ENIG) and 5% are due to board rework amount (0, 1, 2 or 3 times).

For the retention force DoE, much of the data is not explained by the calculated model (R-sq = 77.8%). It was found to be more difficult to estimate and explain the retention force than the insertion force. This implies that different types of damages on pins (or holes) are present that are difficult to predict and to model.

A.7–Results for Reference Connector

As mentioned earlier, the reference connector D has much higher insertion and retention forces compared to the high speed connectors (A, B, C and E). Reference connector D is also more consequent regarding the insertion and retention forces than the new high speed connectors are. For the connector D pins, it was always higher force for ImSn compared to ENIG (bigger holes for ENIG), no effect of board rework (!) and always higher force for small holes compared to nominal and maximum hole sizes.

An example of a graph with all five connectors and all insertion force measurement data is given in Figure 46.

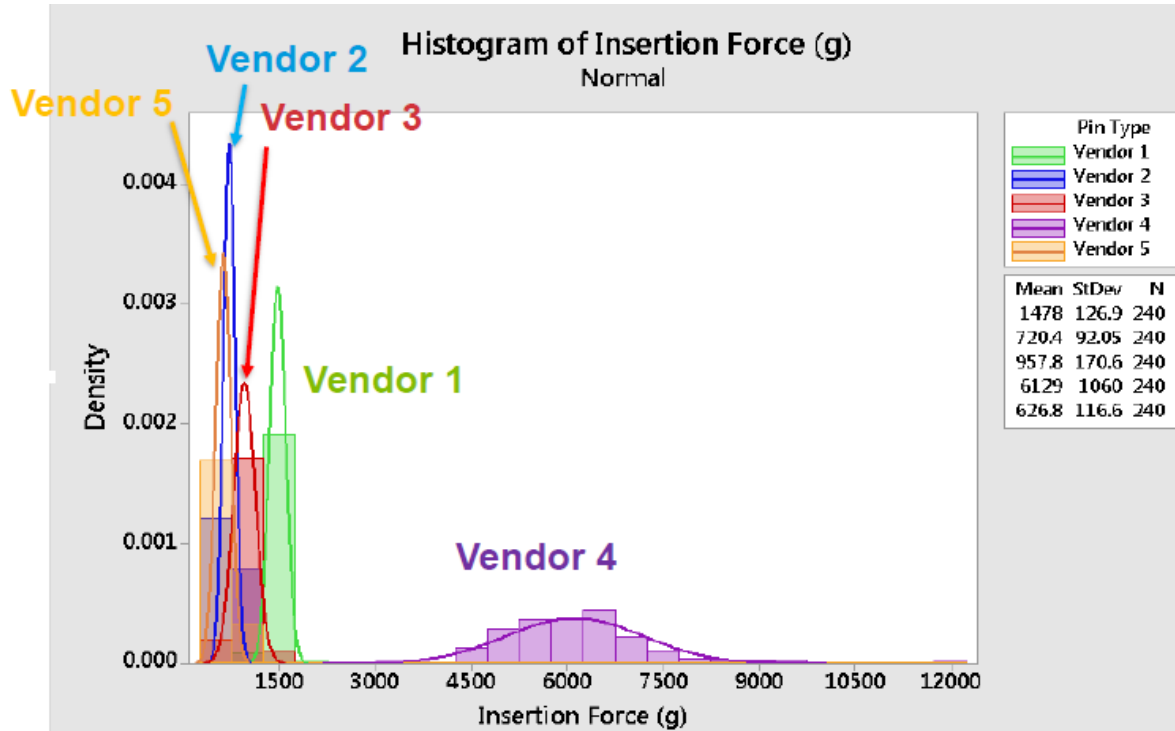

Figure 46 –Histogram of insertion force – (vendor 1 = A, vendor 2 = B, vendor 3 = C, vendor 4 = D and vendor 5 = E).

Figure 46 shows how the inclusion of data from the reference connector D makes it difficult to display differences between the new high speed connectors (A, B, C and E).

A.8–Summary of Insertion and Retention Tests

A summary of the insertion and retention tests is given below:

- The retention force is always lower than the insertion force.
- All four tested factors (pin type, hole plating, amount of rework and hole size) are correlated to the variance of force.
- Pins from reference connector D have both the highest insertion and retention forces followed by A, C, B and E. The pins for the reference connector D is much bigger and stronger in all directions compared to the other tested connectors so it is not surprising that the connections are stronger for the connector D pins. For the evaluated new high speed press fit connector pins, the base material thickness and the shape of the needle eye seem to be most important for the connection strength. However, this does not explain all the differences; all geometry and material differences plays some role in forming the pin-to-hole connection and affect the strength.
- The insertion and retention forces are higher on ImSn plated holes than on ENIG plated holes.
- The fact that the retention force for max hole sizes are bigger than for min hole sizes for the connectors A, C and E indicates that these pins have permanent deformations since insertion in the smallest holes weakens the connections.
- The amount of rework has nearly no effect on the pin insertion and retention forces.

The last conclusion is the most interesting in this rework test. Rework of these press fit connectors does not seem to affect the connection force significantly.

The full report from the insertion and retention tests is indicated in the references for this paper [2].

B. Gas Tightness Tests

In order to investigate if rework of the high speed press fit connectors caused cracks or other damages in the hole plating, gas tightness tests were performed⁵.

The tests were performed in accordance with EIA 364, Test Procedure 23 [3].

B.1-Process

In the gas tightness test, the electrical interface resistance between the compliant pins and their hole walls has been measured for selected pin connections before and after storage in an environment saturated with aggressive gases. The difference in electrical contact resistance indicates the stability of the interfaces.

It was decided to measure the electrical resistance on 13 to 14 pin connections for each combination of component, hole plating and hole size. Examples of chosen pin connections that have been measured are given in Figure 47 and Figure 48.

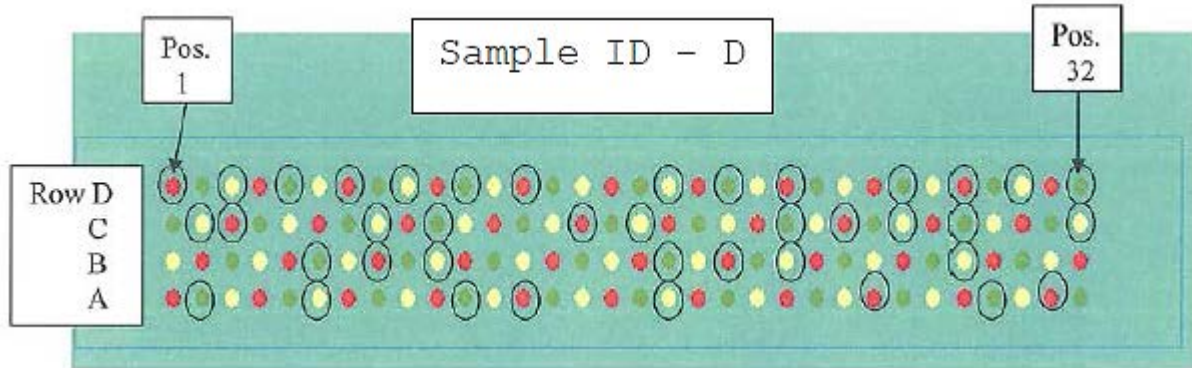

Figure 47 –Connections that have been electrically resistance measured for connector D.

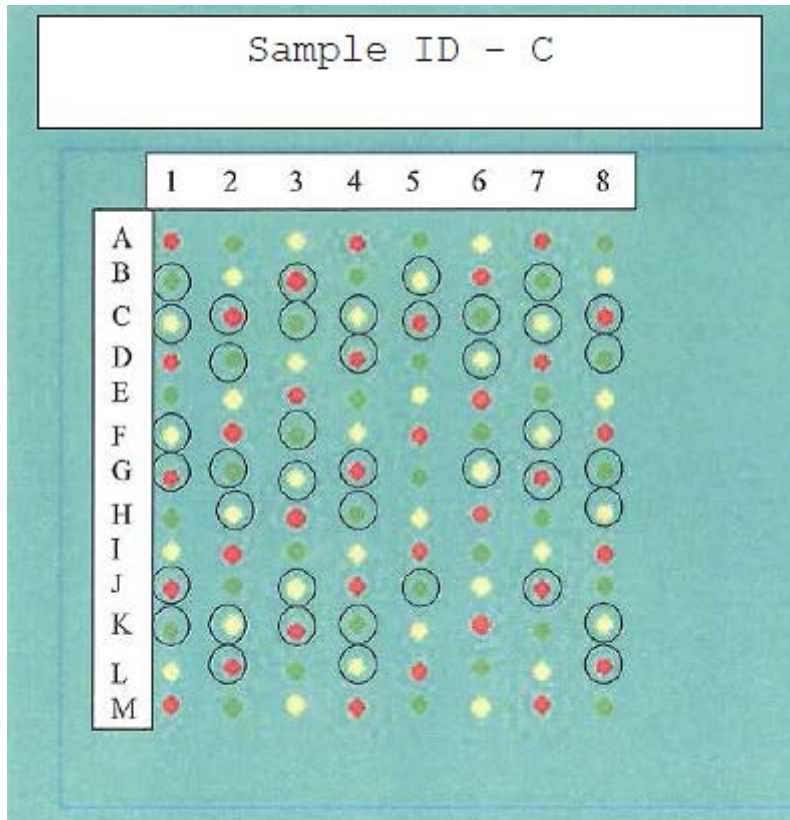

Figure 48 –Connections that have been electrically resistance measured for connector C.

⁵The gas tightness test has been performed by Tom Peel and his staff at Contech Research. All data and pictures in this report from the gas tightness test are from Contech Research.

The interface resistance between pin and hole wall is normally measured by creating an electrical bias between the tip of the pin that protrudes on the secondary side of the board and the top side of the hole plating and then measuring the current in a circuit between the top side of the pin and the bottom side of the plated holes, see Figure 49.

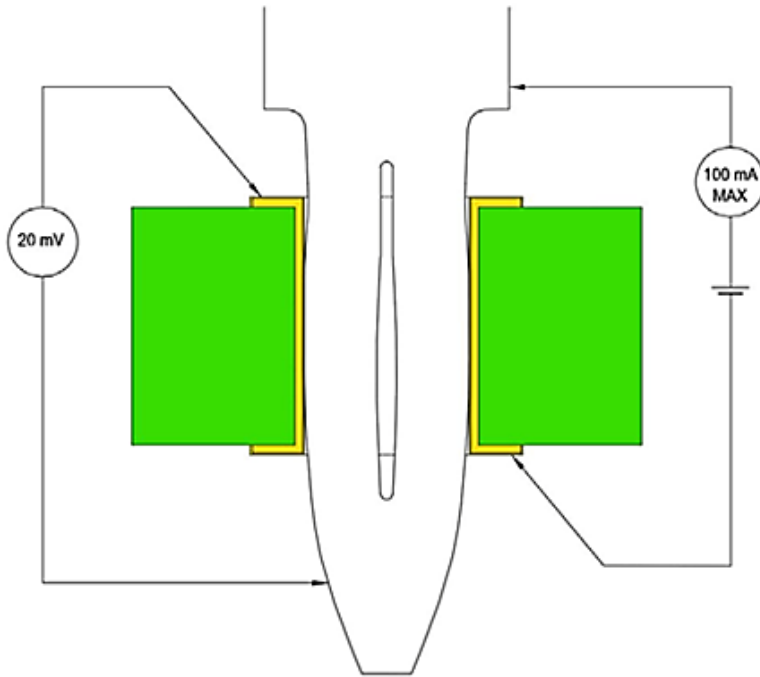

Figure 49 – Contact resistance measured in a traditional way by connecting the protruded pin.

On the tested press fit assemblies, only connector D had pins that protrude on the secondary side. The resistance measurement described above could therefore not be used for the new high speed connectors whose pins did not protrude. Instead, an inner layer was used to create the electrical circuit. A drawing of this measurement design is given in Figure 50.

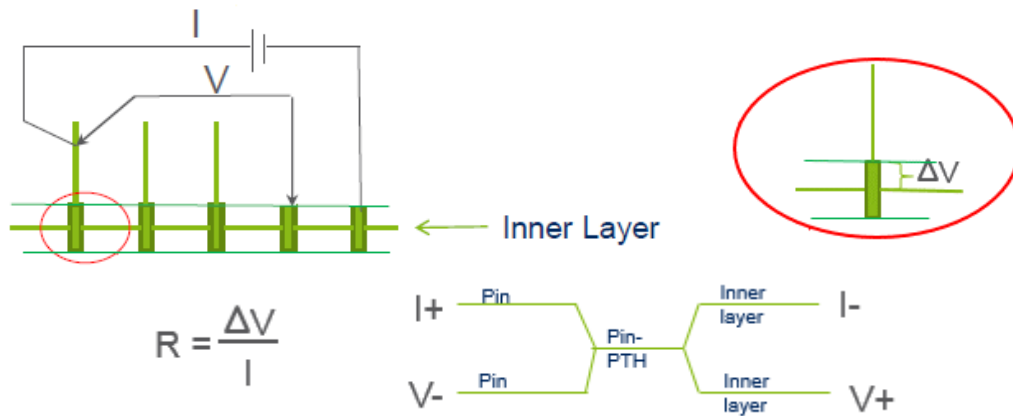

Figure 50 – Contact resistance measured by using an inner layer (when no protruded pins are available)⁶.

The inner-layer-measurement method means that the resistance from the bulk of the pins and the inner layer resistance are added to the contact surface resistance. The resistance values in these measurements are therefore higher than normal contact resistance values for the high speed press fit connectors.

⁶ Drawing and suggested measurement method: David Wice, Ciena.

After the first measurements of the contact resistance between pins and plated hole walls, the boards were placed in test chambers that then were saturated with nitric acid gas, see Figure 51.



Figure 51 – Samples inside test chamber after nitric acid saturation.

After one-hour of aggressive gas exposure, the boards were removed from the test chamber and after another hour of drying, the interface resistances were re-measured. The results from the electrical resistance measurements, before and after aggressive gas storage, were then compared for each measured connection.

B.2–Test Results

13 or 14 compliant pin connections were measured for each combination of connector, hole plating, amount of rework and hole size. Even though this is not many measurement points for each combination, all together about 3200 measurements had to be performed. Because the hole sizes and many of the pin geometries are close to each other (except for reference component D), the measurements give, anyway, good information about how rework of the high speed press fit connectors affect the interface resistance for new high speed press fit connectors.

An example of resistance values before and after storage in aggressive gases for assemblies with previously zero, once, twice or three times rework for connector C on ImSn boards for the smallest hole is given in Table 8.

Table 8– Compliant pin interface resistance [mΩ] - connector C in ImSn plated, minimum size holes.

Pos. ID	0x Rework		1x Rework		2x Rework		3x Rework	
	Initial Resistance	Resistance after Gas Test	Initial Resistance	Resistance after Gas Test	Initial Resistance	Resistance after Gas Test	Initial Resistance	Resistance after Gas Test
B-3	2.7	2.9	2.9	2.8	2.0	2.6	2.8	2.9
C-2	2.2	2.8	2.8	2.8	2.8	2.6	2.8	2.8
C-5	2.9	2.7	2.8	2.8	2.8	2.9	2.8	2.5
C-8	2.7	2.7	2.7	2.8	2.1	2.7	2.6	2.9
D-4	2.1	2.7	2.6	2.9	2.5	2.5	2.7	2.8
G-1	2.7	2.8	2.8	2.8	2.4	2.6	2.7	2.8
G-4	2.7	2.7	2.8	2.7	2.7	2.9	2.8	2.7
G-7	2.8	2.8	2.7	2.7	2.5	2.8	2.8	2.7
J-1	2.9	2.1	2.7	2.8	2.5	2.8	2.7	2.8
J-7	2.7	2.7	2.8	2.8	2.7	2.8	2.8	2.8
K-3	2.5	2.3	2.7	2.9	2.7	2.8	2.8	2.7
L-2	2.5	2.7	2.8	2.7	2.6	2.7	2.9	2.9
L-8	2.7	2.7	2.8	2.8	2.1	2.7	2.8	2.6
Max	2.9	2.9	2.9	2.9	2.8	2.9	2.9	2.9
Min	2.1	2.1	2.7	2.7	2.0	2.5	2.6	2.5
Avg	2.6	2.7	2.8	2.8	2.5	2.7	2.8	2.8
StD	0.2	0.2	0.1	0.1	0.3	0.1	0.1	0.1

As can be seen in Table 8, the resistance values do not change much (or sometimes even not at all) after storage in aggressive gases after zero to threetimes rework for connector C and this is actually true for all the tested combinations of components, plating, hole sizes and amount of rework.

In order to find out if there could be significant differences between the average measured electrical contact resistance before and after the storage in aggressive gases, 2-sample t-tests were performed for the normal distributions created for each combination of plating, hole diameter, connector and amount of rework. This was performed even though the sample sizes for each single normal distribution are too small to draw statistical conclusions. However, by doing these calculations for all test combinations, general trends and patterns could be estimated.

A typical example of the results from these hypothesis tests is given in Figure 52.

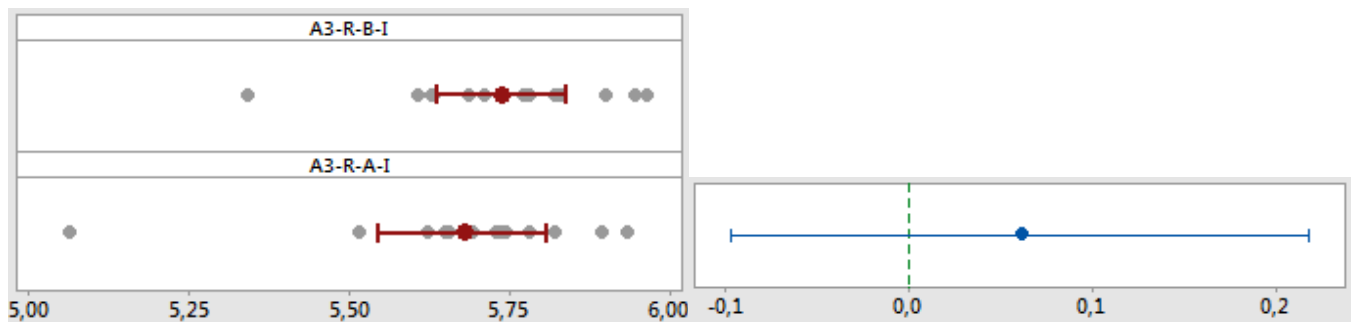

Figure 52 – Data distribution (left), 95% C.I. for difference (right) –connector A, 3 reworks, ImSn, min hole.

The example above shows that the difference in mean between A3-R-B-I (connector A, 3 reworks, smallest hole, before aggressive gas storage, ImSn plating) and A3-R-A-I (connector A, 3 reworks, smallest hole, after aggressive gas storage, ImSn plating) is 0.061 mΩ and that the 95% confidence interval is -0.097 to 0.218 mΩ. In other words, it is not enough evidence to conclude that the means differ at the 0.05 level of significance.

After that 2-sample t-tests had been performed for the contact resistance distributions for all 120 combinations of hole sizes, connectors, amount of rework and hole plating, the following could be found:

- No conclusion about significant contact degradation during storage in aggressive gases could be drawn for connector A.
- Connector B had 3 of 24 comparisons where the contact resistance after aggressive gas storage was higher than before the aggressive gas storage, but there was no logic regarding hole sizes (1 min, 1 nom, 1 max) and amount of rework (0 and 2 reworks (but not any with 3 reworks!)) and the differences were very small. No conclusion on significant contact degradation could therefore be drawn.
- For connector C, no difference in contact resistance could be found for any combination of hole plating, hole size and amount of rework except for after three reworks on ENIG where it was consistently higher resistances after aggressive gas storage for all three hole sizes.

These press fit connections need to be specially analyzed after cross sectioning, in order to find out if there are real damages or if it only is the random variation of the measurement data that is the reason. As mentioned, there were only 13 measurements for each combination of hole size, hole plating and amount of rework, which is an unsure sample size in order to create normal distributions.

- No significant contact degradation during storage in aggressive gases for connector D.
- No significant contact degradation during storage in aggressive gases for connector E.

A comparison between each test combination's standard deviations was also performed and no conclusion about consequent differences in the standard deviation of data could be drawn from this hypothesis test (2-sample standard deviation test).

A series of resistance data from before and after aggressive gas storage for connector B, after three reworks, on nominal holes is given in Figure 53.

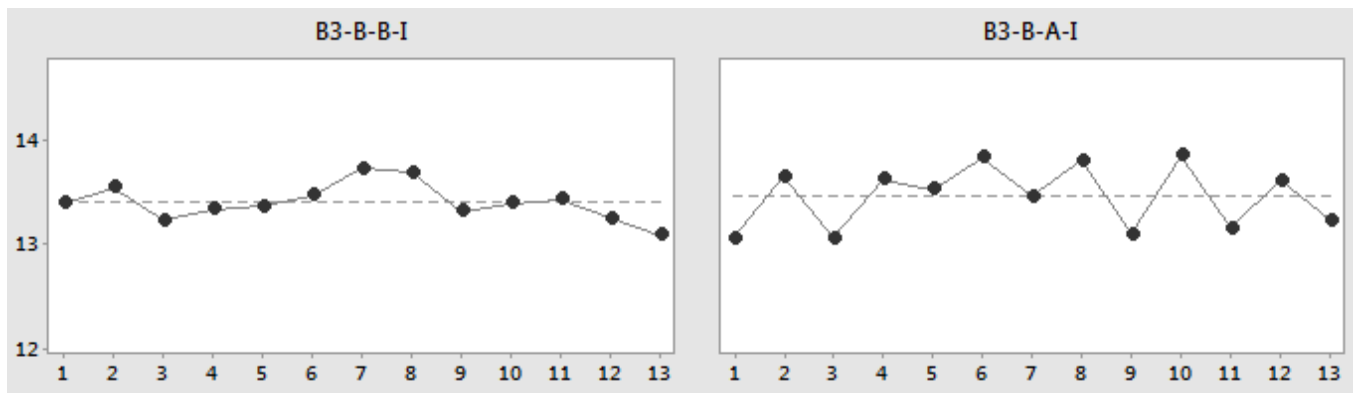

Figure 53 – Resistance data in worksheet order, before aggressive gas storage (left) and after the storage (right) – connector B, 3 reworks, nominal hole, ImSn.

B.3–Summary from Gas Tightness Test

There were very small differences in electrical contact resistance for the different combinations of connectors, amount of rework, hole sizes and plating. The assemblies are stable. Multiple rework had led to no, or to very little, hole damages.

The full report from the gas tightness test, with all measured contact resistance values, is indicated in the references section of the paper [4].

C. Cross Sectioning

Horizontal and vertical cross sections were performed following the standard Telcordia GR-1217-CORE [1]⁷ and judged by IPC J-STD-001F Requirements for Soldered Electrical and Electronic Assemblies [5], IEC 60352-5M Ed. 3/CD Solderless Connections – Part 5 [6] and IPC-6012B Qualification and Performance Specification for Rigid Printed Boards [7].

Each component was cut out from the board (together with the inserted pins and the board) and then cut in two parts; one for vertical cross sectioning and the other one for horizontal. After being divided in two, each part was cast into plastic and then milling and polishing was performed.

Only boards that had been subjected to zero rework and to three reworks were cross sectioned.

C.1-Vertical Cross Sectioning

The vertical cross sectioning was performed in automatic milling and polishing equipment that made it possible to receive good centered views of whole rows of inserted connector pins. An example of this is shown in Figure 54.

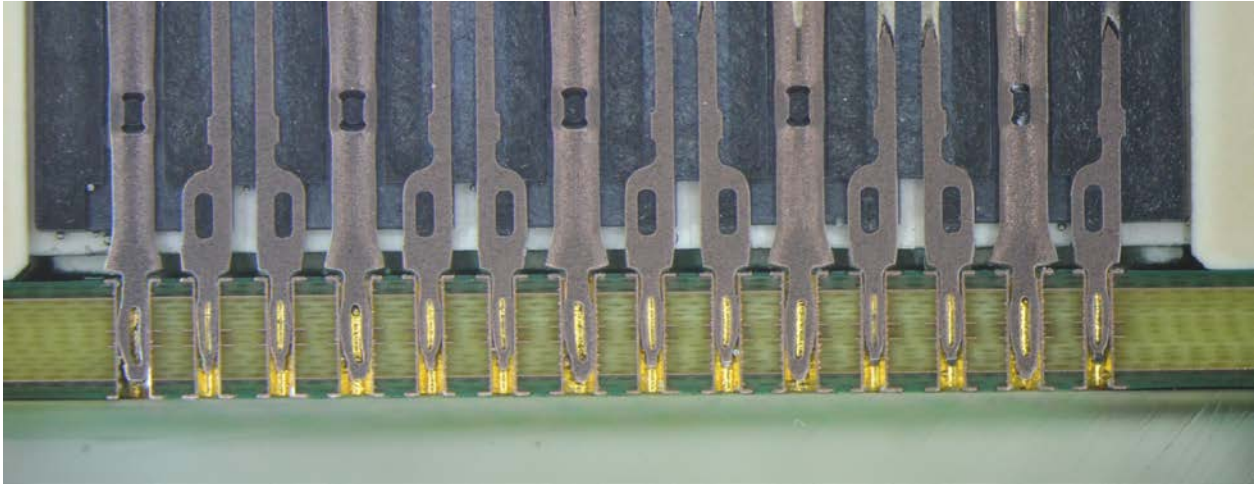

Figure 54 – Vertical cross sectioning of connector B.

Another cross section that shows a whole row of signal pins for the connector A is given in Figure 55.

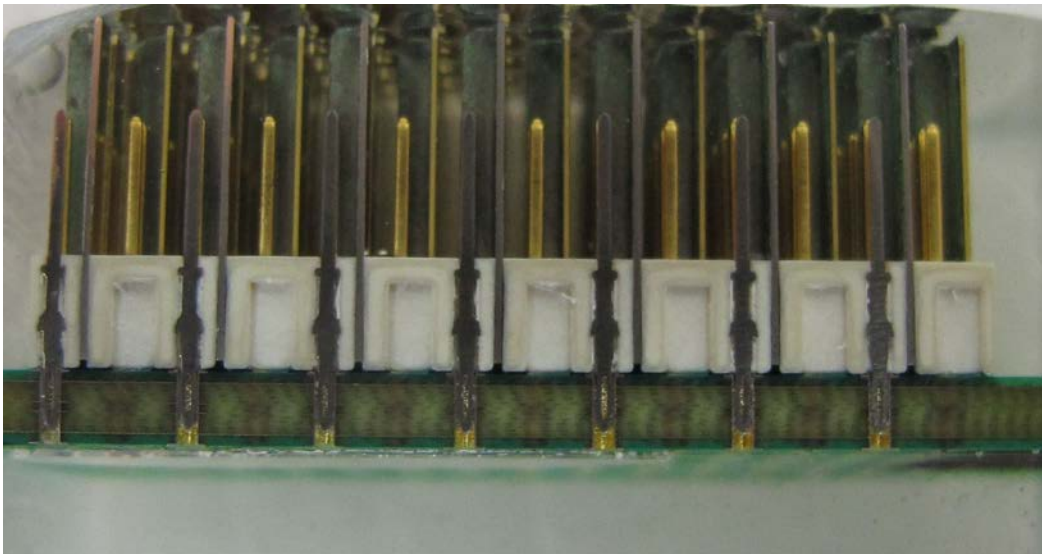

Figure 55 – Vertical cross sectioning of connector A.

⁷The cross sections in this study have been performed either by CEPERI or by Tyco Electronics.

The cross sections do not show much hole deformations or hole damage for any of the tested connectors, amount of previous preformed rework or type of hole plating. However, the pin deformation increases when pressing into the minimum specified hole diameters and this results, in many cases, in permanently deformed needle eye pins. The limit for elastic deformation has been passed and plastic deformation has taken place. Examples of this, for the signal pins for the connectors A, B, C and E are shown in Figure 56, Figure 57, Figure 58 and Figure 59.

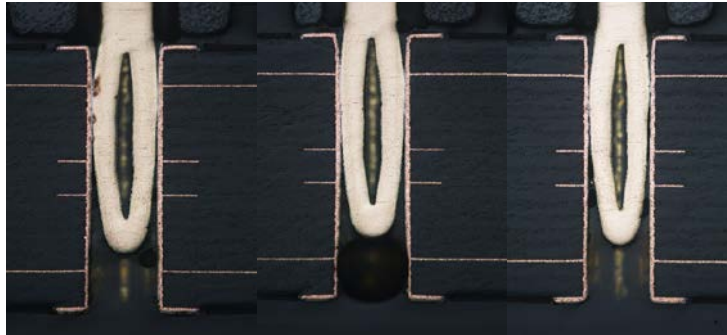

Figure 56 – Vertical cross sectioning of connector A, ENIG plating – maximum specified hole diameter (left), nominal diameter (middle) and minimum diameter (right).

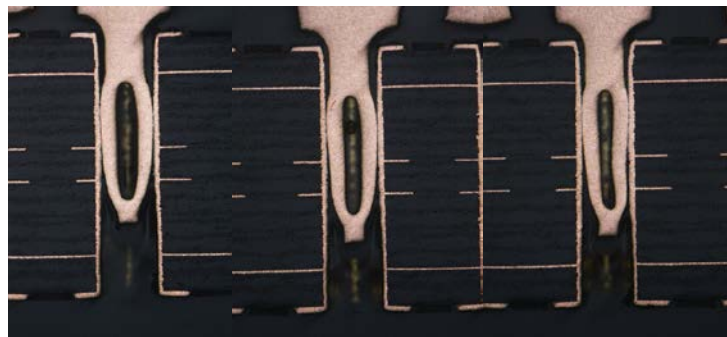

Figure 57 – Vertical cross sectioning of connector B, ENIG plating – maximum specified hole diameter (left), nominal diameter (middle) and minimum diameter (right).

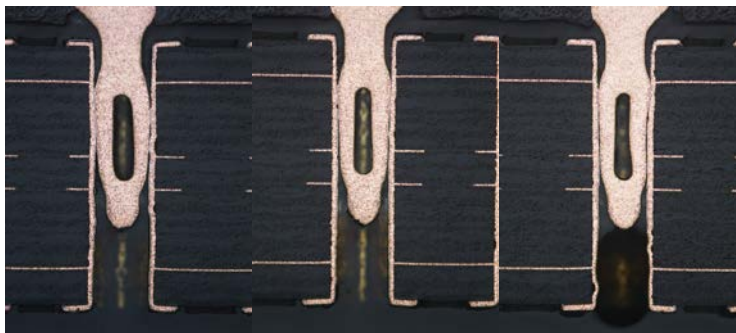

Figure 58 – Vertical cross sectioning of connector C, ENIG plating – maximum specified hole diameter (left), nominal diameter (middle) and minimum diameter (right).

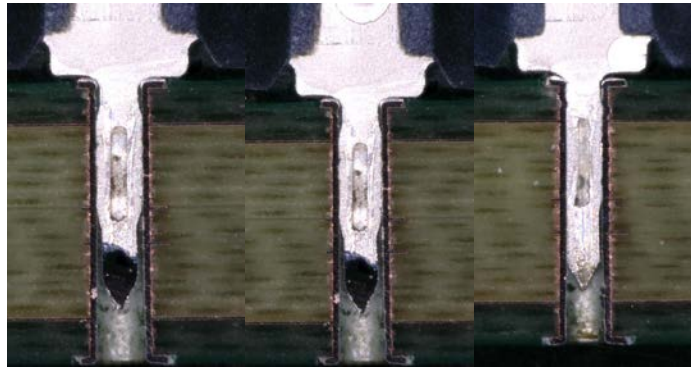

Figure 59 – Vertical cross sectioning of connector E, ImSn plating – maximum specified hole diameter (left), nominal diameter (middle) and minimum diameter (right).

A closer look at the contact surfaces show that there are few and small amounts of damages, but also that the actual contact surface area often is rather small. Examples of this is shown in Figure 60.

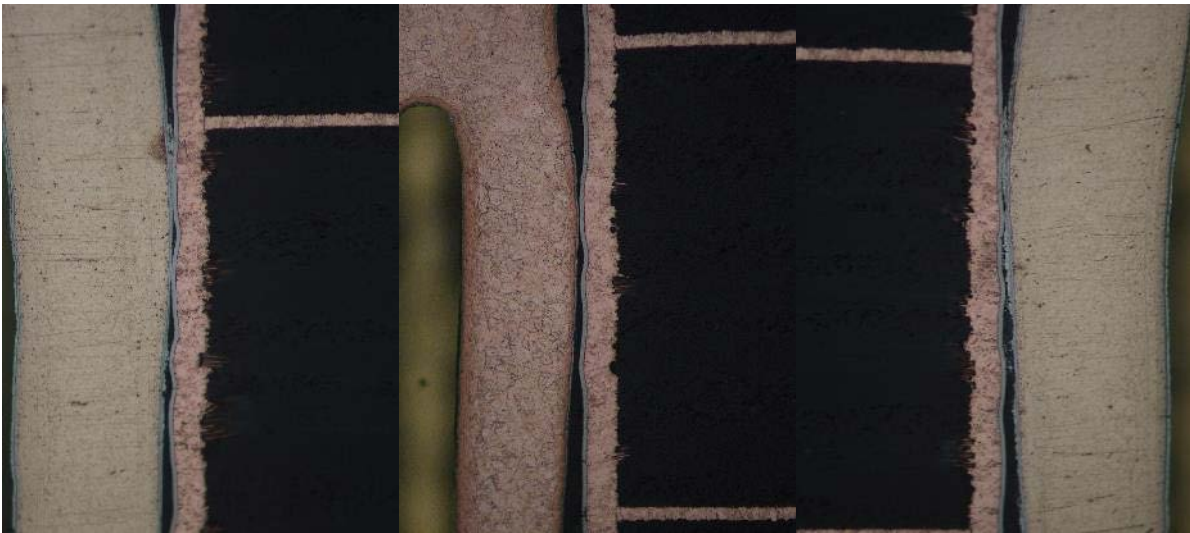

Figure 60 – Close view of contact surfaces – connector A (left), B (middle) and C (right) all in ENIG holes.

The connection for the reference component D is very different compared to the small new high speed connector connections. However, the load is evenly distributed over the hole wall and it also has nearly no hole damage for this big and strong compliant pin.

Two photos from a cross section of reference pin D in an ENIG hole that previously had been subjected to three reworks are shown in Figure 61.



Figure 61 – Vertical cross sectioning of reference connector D, ENIG plating.

The vertical cross sectioning did show very limited hole damage for all cross sectioned components. No lifted pads, cracked hole walls or cracked inner layers were found. However, in the smallest holes, the high speed press fit connector pins were found to have permanent deformations which are the reason that they lost some of their connection strength.

C.2–Horizontal Cross Sectioning

The horizontal cross sectioning was performed in such a way that it was possible to receive good views of the whole board area with the inserted pins for each component. An example of this is shown in Figure 62.

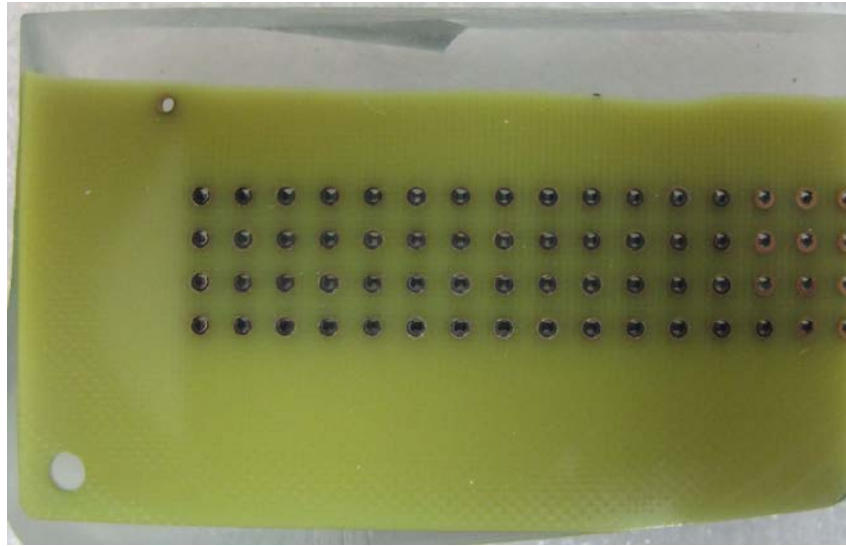
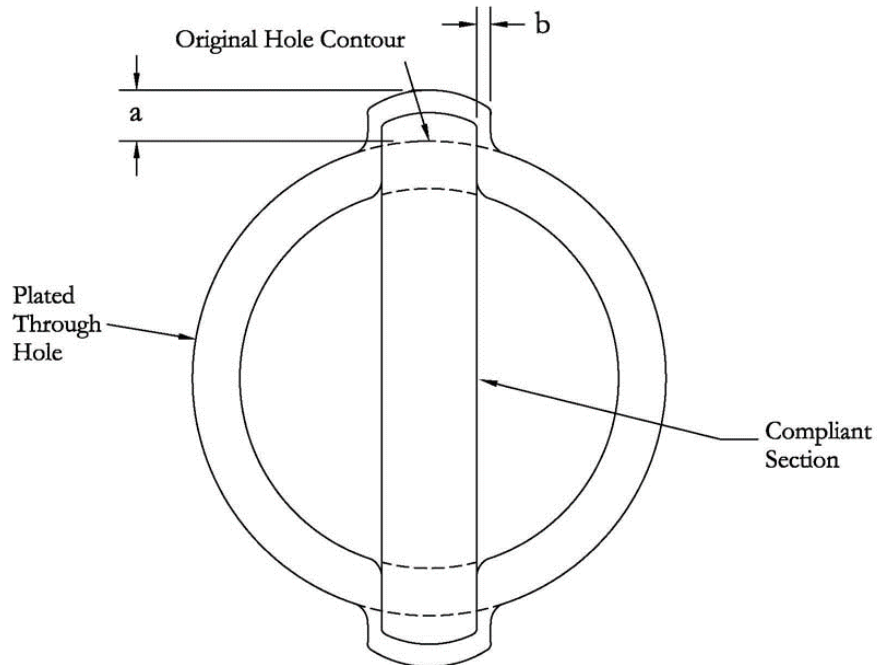

Figure 62 – Horizontal cross sectioning of reference connector D, ImSn plating.

In the horizontal cross sectioning, the polishing stopped 0.2 mm to 0.3 mm below the top surface of the board. This is a distance that is within the specification of Telcordia GR-1217-CORE [1], which is $0.3 +0.2/-0.1$ mm. At this distance from the board top surface, for the new high speed press fit connectors, the horizontal cross sectioning will most often not show the compliant pins in contact with the hole wall. The limits for hole wall deformation are given in Figure 63 and in the comments below.



a = Radial deformation distance
b = Minimum copper thickness in deformation area

MEASUREMENTS TAKEN $0.0120 + 0.0080 / -0.0040$ INCH ($300 + 200 / -100$ μ m)
BELOW INSERTION SIDE OF BOARD.

Figure 63 – Description of hole deformation after horizontal cross sectioning, Telcordia GR-1217-CORE [1].

Dimension “a” in Figure 63 is not allowed to be bigger than 50 μm and dimension “b” has to be measured and recorded according to Telcordia GR-1217-CORE [1], but no limit is specified.

Two examples from the horizontal cross sectioning is given in Figure 64, which is from connector B on ImSn and connector E on ENIG plated hole. Both photos show pins inserted in minimum hole sizes after three times rework.

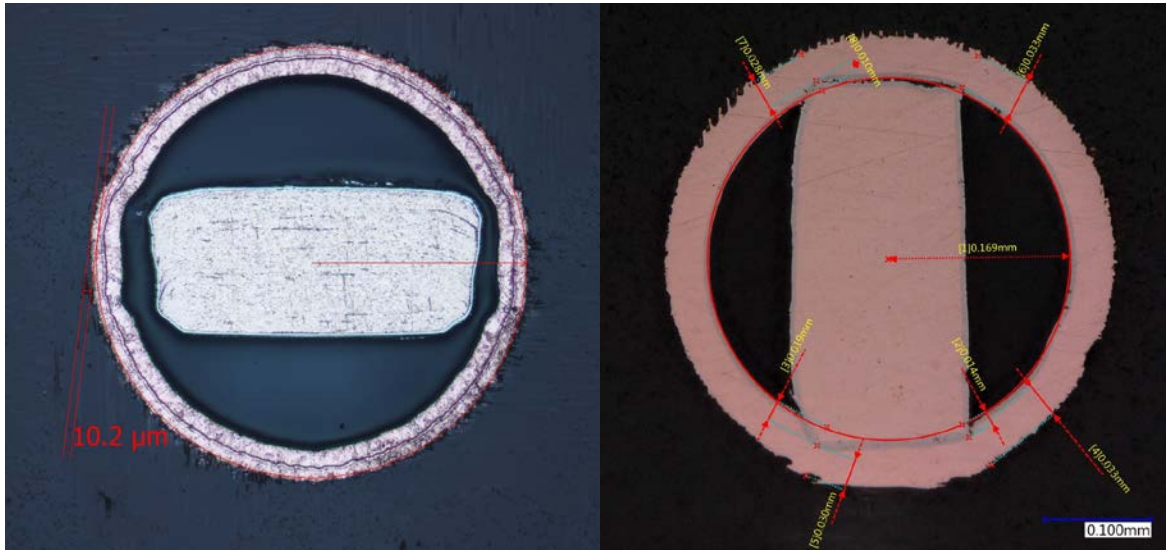

Figure 64 – Horizontal cross sectioning, connector B, ImSn plated hole, 3 times rework (left) - connector E, ENIG plated minimum hole, 3 times rework (right).

A photo from horizontal cross sectioning of a pin connection from the reference connector D is given in Figure 65.

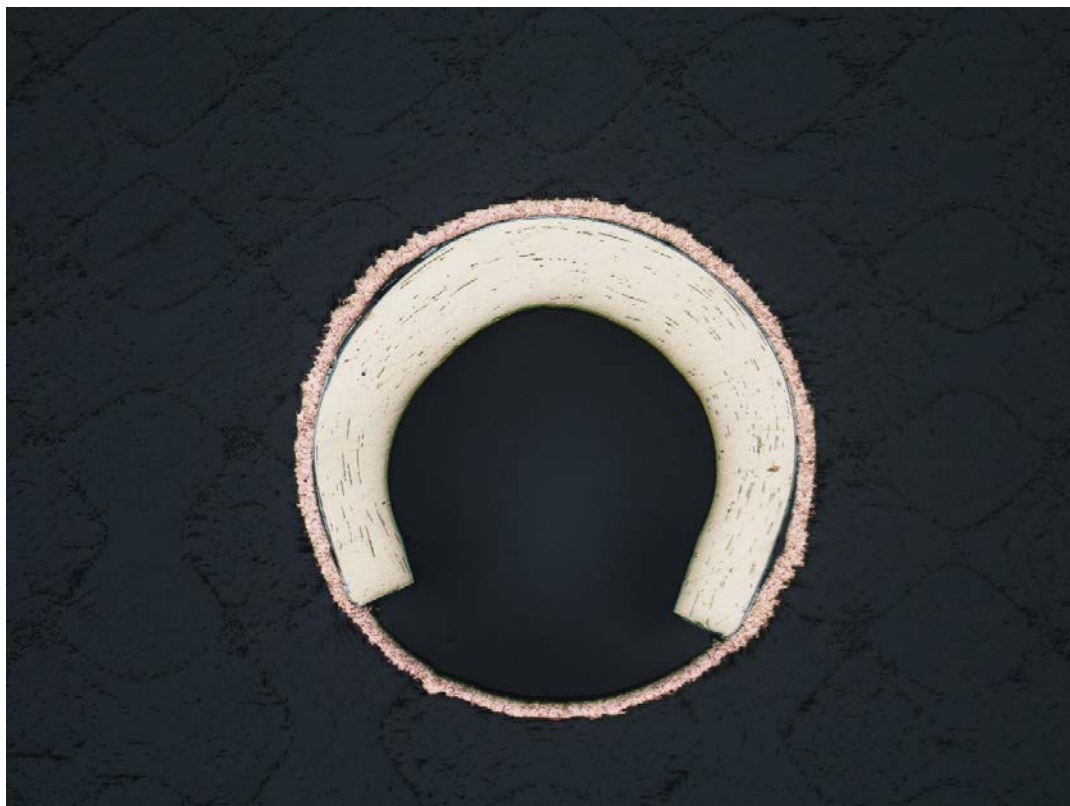

Figure 65 – Horizontal cross sectioning of reference connector D, ImSn plated hole, 3 times rework.

The horizontal cross sectioning did not show any hole damage that surpassed the specified limits in Telcordia GR-1217-CORE [1].

Connector C pins in ENIG holes that had previously been reworked three times were specially studied because of a possible statistical increase in electrical resistance in the gas tightness test, but no hole damages were found on these assemblies. The

statistical study of the data from the gas tightness test for these assemblies gave a false alarm because of the relatively low number of measured pin-to-hole resistances for each combination of pin type, number of reworks, hole plating and hole sizes.

VI. Conclusions and Recommendations

Multiple reworks of a new family of high speed press fit connectors was found to have little or no effect on hole damage and connection strength. All tested press fit connectors could be reworked up to three times if the recommended rework processes and tooling are used for each of the tested connectors.

What really does affect the connection strength are the size, material and geometries of the press fit pins, the hole sizes and the plating of the holes. Of the tested connectors, the reference connector D has the highest connection strength followed by the high speed connectors A, C, B and E.

The insertion and retention forces were shown to be higher on ImSn plated holes than on ENIG plated holes. Smaller hole sizes for the ImSn plated holes compared to the ENIG plated holes in this test could be the reason for this difference.

The connection strength for pins in maximum specified final hole diameters are bigger than for minimum hole sizes for the connectors A, C and E because these connector pins are so much deformed during insertion that permanent plastic deformation takes place. When the pins lose their elasticity, the pressure towards the inner hole walls decreases and the connection strength becomes lower. The high speed press fit connector B does not show any difference at all in connection strength dependent on hole size. This means that some plastic pin deformation takes place in the smallest holes. The connection strength should otherwise be higher for the smallest holes compared to the nominal and maximum hole sizes. The plastic pin deformation for connector B is, however, slightly lower than for the connectors A, C and E.

Even though the press fit pin connections in the minimum diameter holes are gas tight and that there are no big differences in connection strengths compared to the bigger holes, it is recommended that the manufacturers of these new high speed press fit connectors review their pin designs and the specified minimum final hole sizes and the suggestion from this study is to increase these limits.

VI. Abbreviations

The following abbreviations are used in this paper:

ANOVA = Analysis of Variance, which is a collection of statistical models to analyze the differences among group means.

DoE = Design of Experiment, applied statistics that deals with planning, conducting, analyzing and interpreting controlled tests to evaluate the factors that control the value of a parameter or group of parameters.

ENIG = Electroless Nickel Immersion Gold, surface plating with ~0.05 to 0.15 μm gold over ~3 to 6 μm nickel on copper.

HDP = High Density Packaging User Group, a consortium where companies cooperate in projects with main focus on characterization and reliability of electronic assemblies and sub-assemblies.

ImSn = Immersion tin, surface plating with ~0.5 to 1.25 μm of tin on copper.

R-sq = R squared, which is a statistical measure of how close test data are to the fitted line for a regression model.

VII. References

- [1] Telcordia GR-1217-CORE
- [2] Dennis Willie et al., HDPUG Press Fit Technical Report FA # 61744, 2016
- [3] EIA 364, Test Procedure 23
- [4] Thomas Peel, Gas Tight Testing on Compliant Pins, HDP User Group, June 29, 2016
- [5] IPC J-STD-001F, Requirements for Soldered Electrical and Electronic Assemblies
- [6] IEC 60352-5M Ed. 3/CD, Solderless Connections – Part 5
- [7] IPC-6012B, Qualification and Performance Specification for Rigid Printed Boards

VIII. Acknowledgements

The author is grateful to the following colleagues, HDP User Group members and supporters that have contributed to the development of methods, performed measurements and reviewed the paper:

Ceperi: Tao Lu

Contech Research: Tom Peel

Ciena: David Wice

Dell: Wallace Ables, Jacky Zhang

Ericsson AB: Anne-Kathrine Knoph, Marie Press, Benny Gustafson, Esmail Dastbaravardeh, Ove Isaksson, Torgny Dahl, Jesper Wittborn, Kjell Asp, Roland Westergren, Rolf Alexandersson, Binas Nisic

Erni: Bernd Eifer

FCI: Jeffrey Toran, John Thompson, Jim Kopec

Flex: Francoise Sarrazin, Dennis Willie, Kelvin Wong, Christopher Vu, Jie Lian, Christian Biederman, Wesley Tran

Fujitsu: Jordan Chaney

HDPUser Group: John (Jack) Fisher

Molex: Zach Bradford

Nokia: Joe Smetana

Oracle: Karl Sauter

Sanmina: Doug Thomas

Tyco Electronics: Rickard Barrefelt, Per Nordström, Magnus Andersson, Doug Lawrence, Victor Torres

Rework of New High Speed Press Fit Connectors

Lars Bruno, Ericsson AB, Sweden

A Project Performed in the HDP User Group

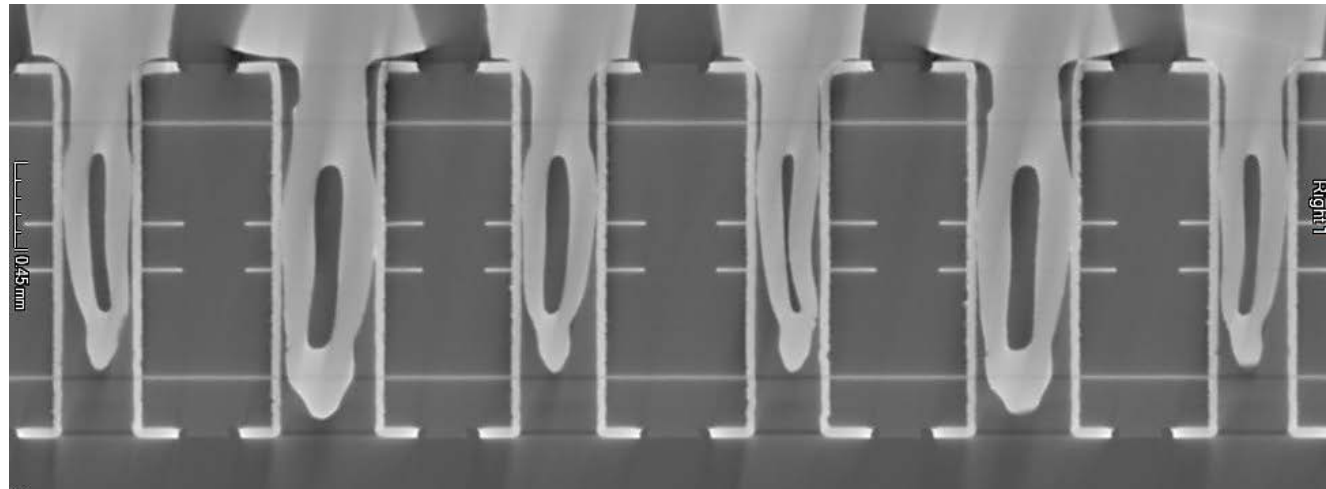

Background

- Increased need for high speed electronics.
 - *Increased demand on mobile access to video, music, chatting, photos, gaming, social networking etc.*
 - *More and more machine to machine communication.*
 - *Data to and from huge data storage centers (cloud).*
- Important link in high speed electronics.
 - *high speed press fit connectors.*
- These new high speed connectors have assembly concerns:
 - *Thin (weak) leads, small pitches, small tolerances.*
 - Risk of bending leads during insertion.
- That leads to the question...How does rework of these high speed connectors affect the plated holes and the strength of the connections?

Purpose

- The goal with this project was to understand and to document how rework affects press fit connection strength, hole wall deformation and gas tightness for new high speed press fit connectors.

Methodology

- 0x, 1x, 2x and 3x rework have been performed on assemblies with:
 - *Different new high-speed connectors with small pin sizes and pitches.*
 - *Three different hole sizes for each component (minimum, nominal and maximum specified final hole diameters).*
 - *ENIG and ImSn hole plating.*
 - *Moreover, standard board materials and designs have been used.*

- Tests and analyses that have been performed:
 - *Gas tightness*
 - *Insertion & retention*
 - *Cross sectioning*

Tested Connectors

- The backplane connectors in the following series have been used.

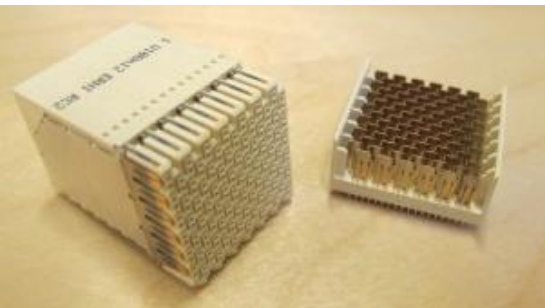

A



B

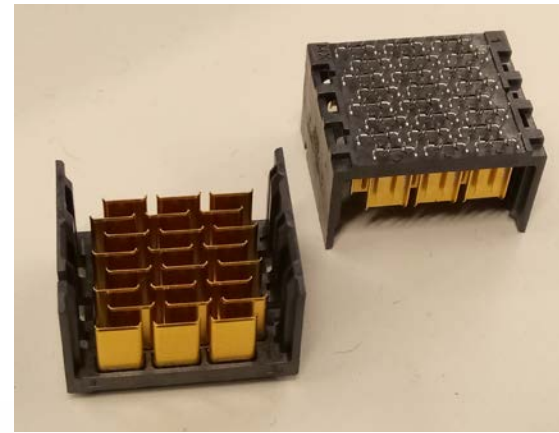

C

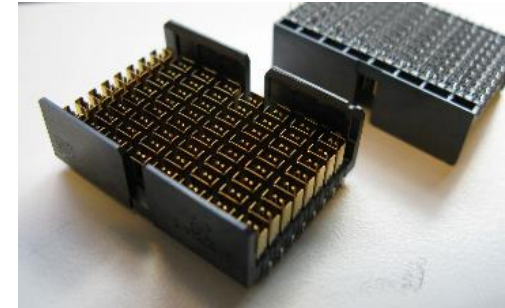

E

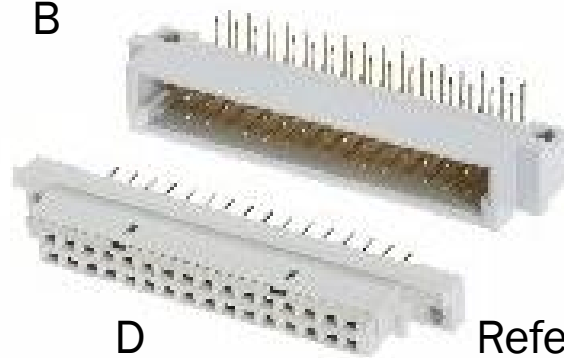

D

Reference connector

Connector Pins

- Connector pins have been documented.

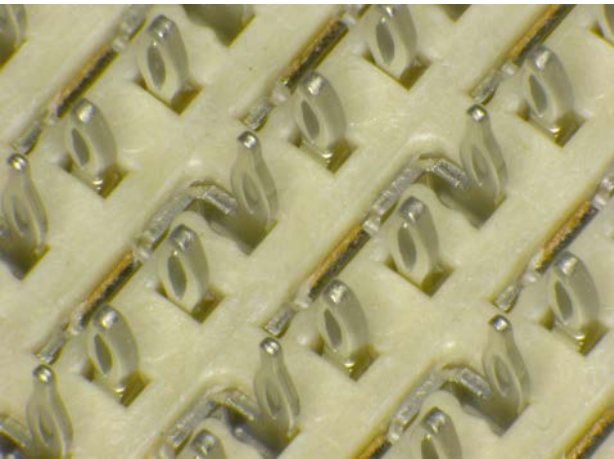

A



B

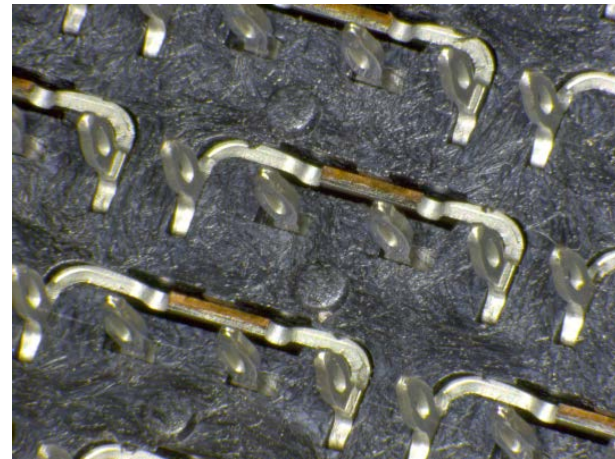

C



E

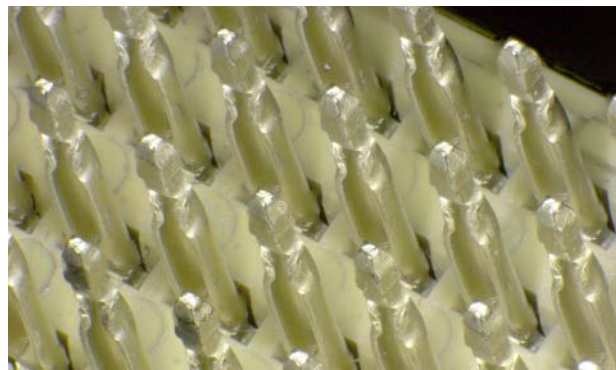

D

Reference connector

Connector Pins

- The connector pins have been measured.

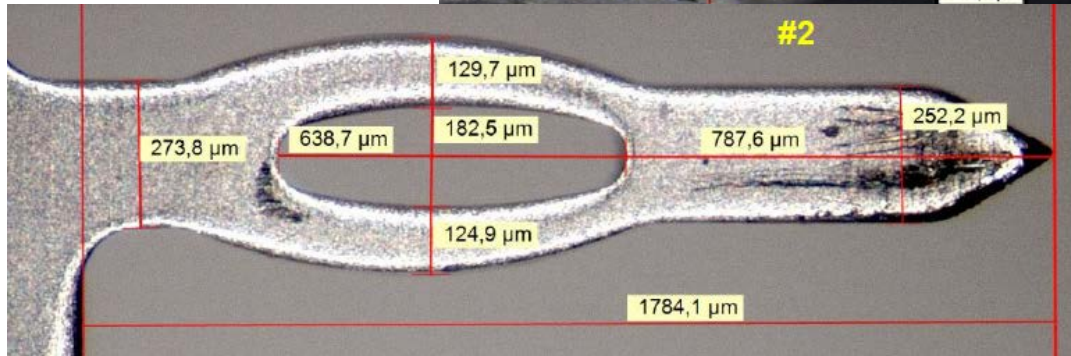
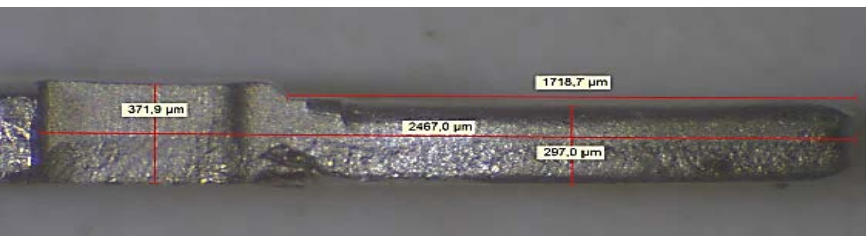
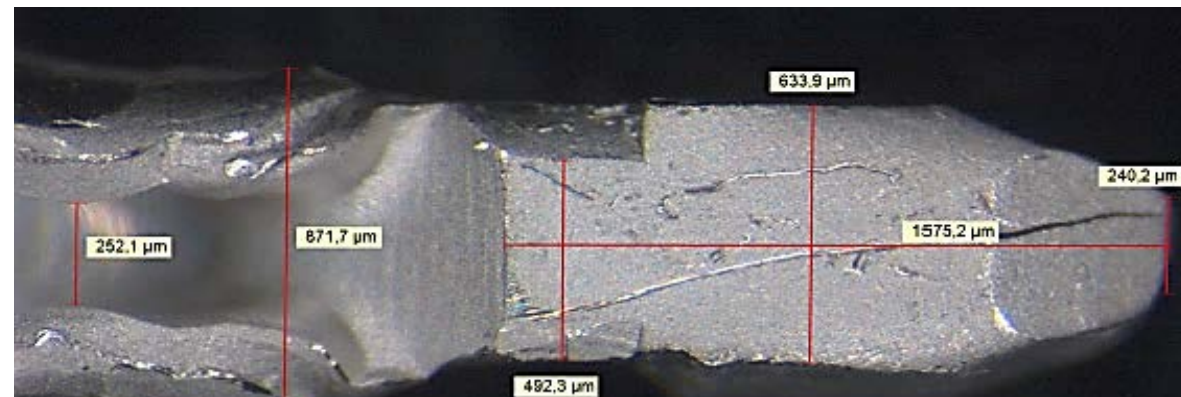
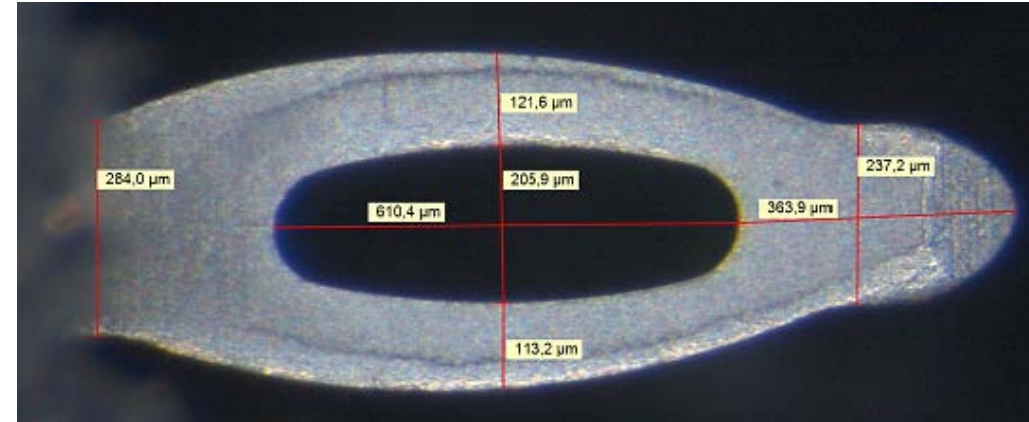
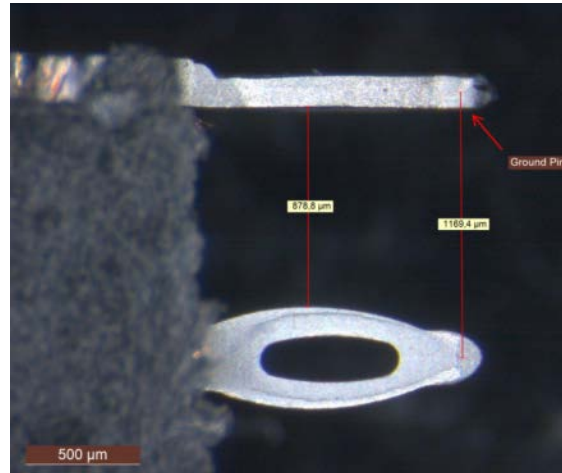
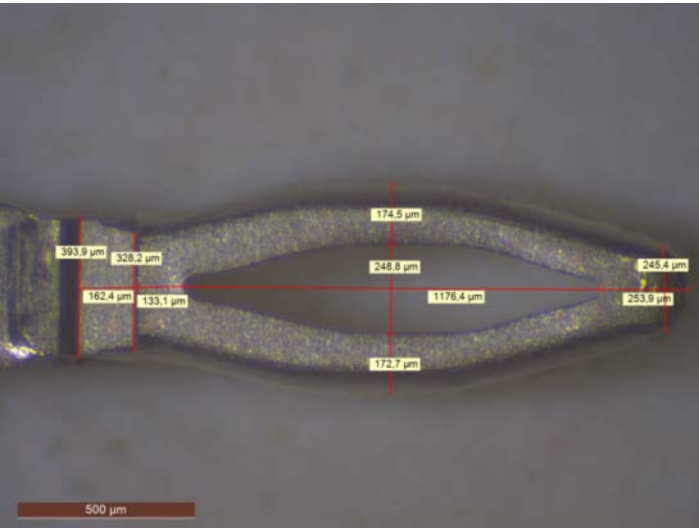

Test Board

- Standard board parameters for a base station or core network board.
 - *Except for number of layers (only 6) and size (only 100 mm x 100 mm).*

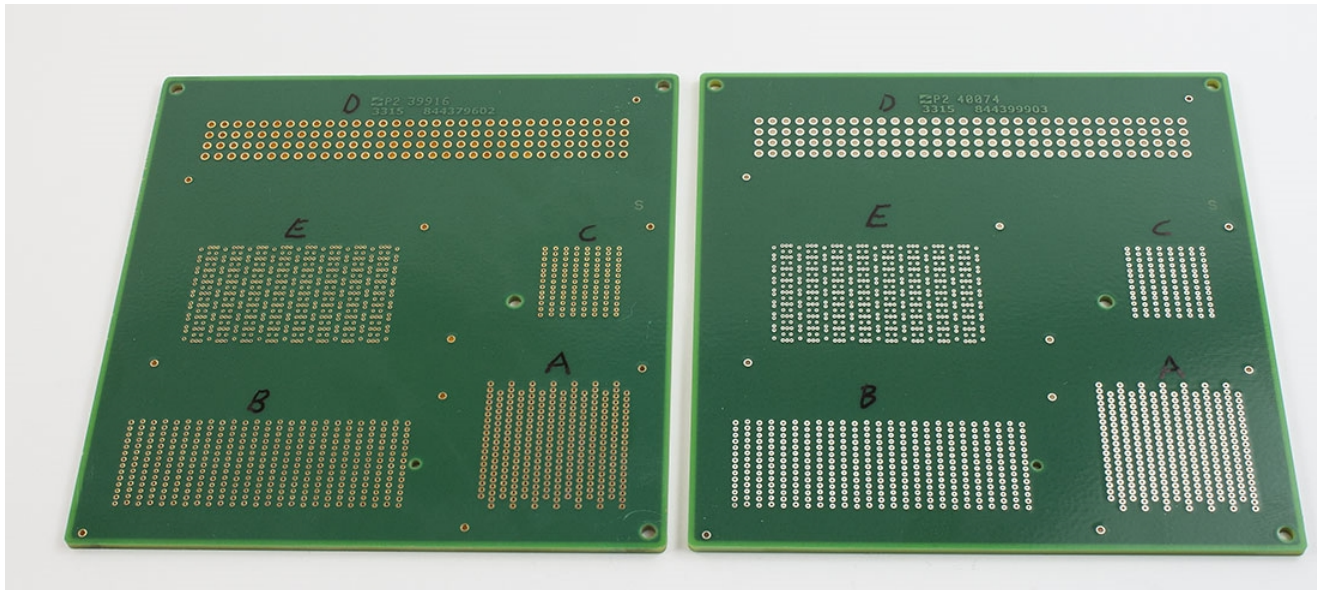

ENIG

ImSn

Hole sizes

- Hole sizes include each connector's specified min, nom and max final hole diameters.
 - *All different hole sizes on each component site.*

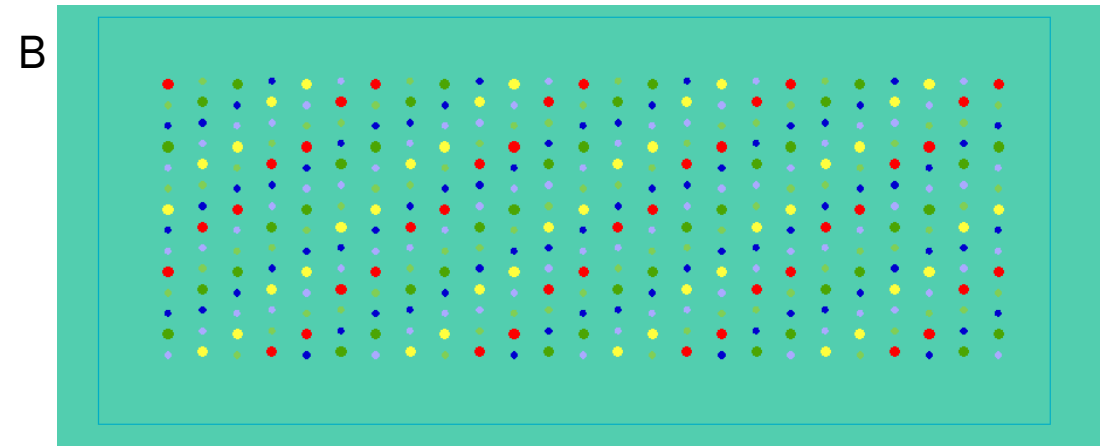
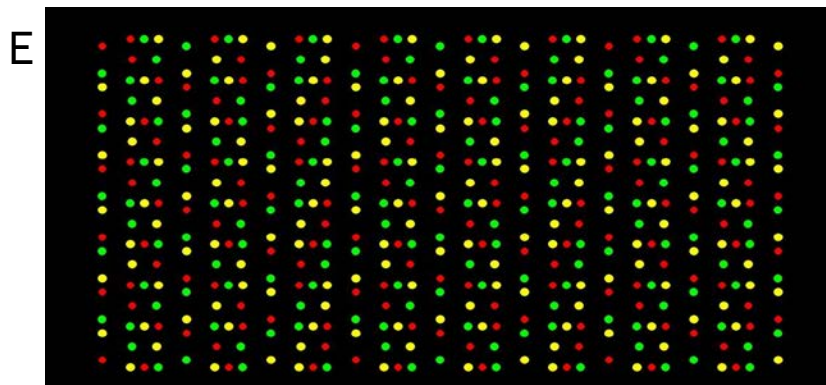
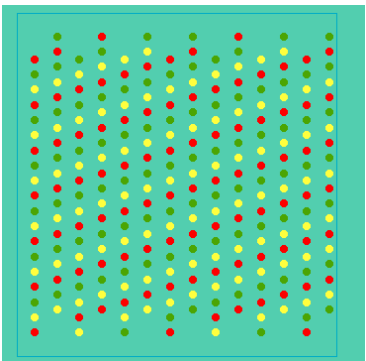

A

E

B

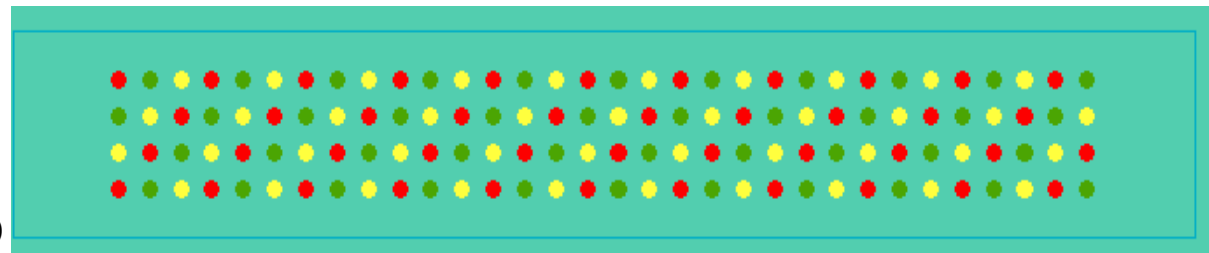
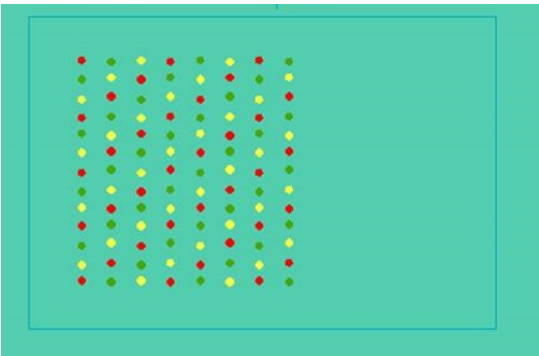

C

D

Hole Measurements

- Cross sectioning
- Optical measurements
- Pin gauges

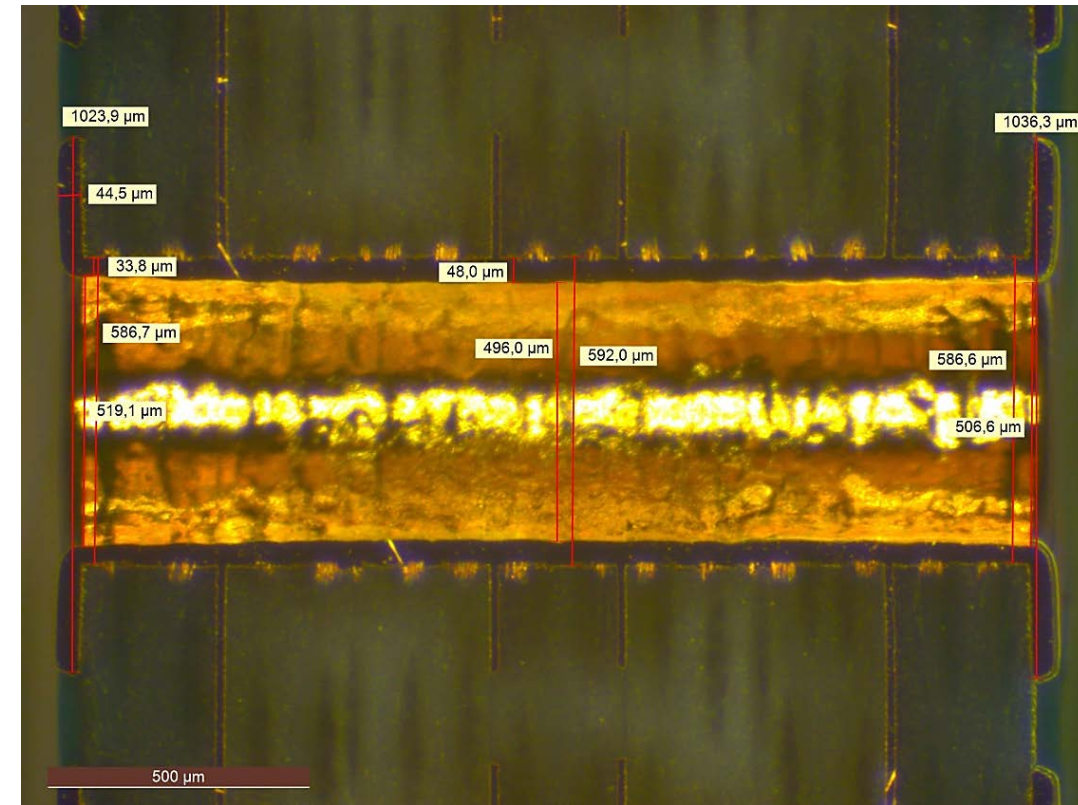
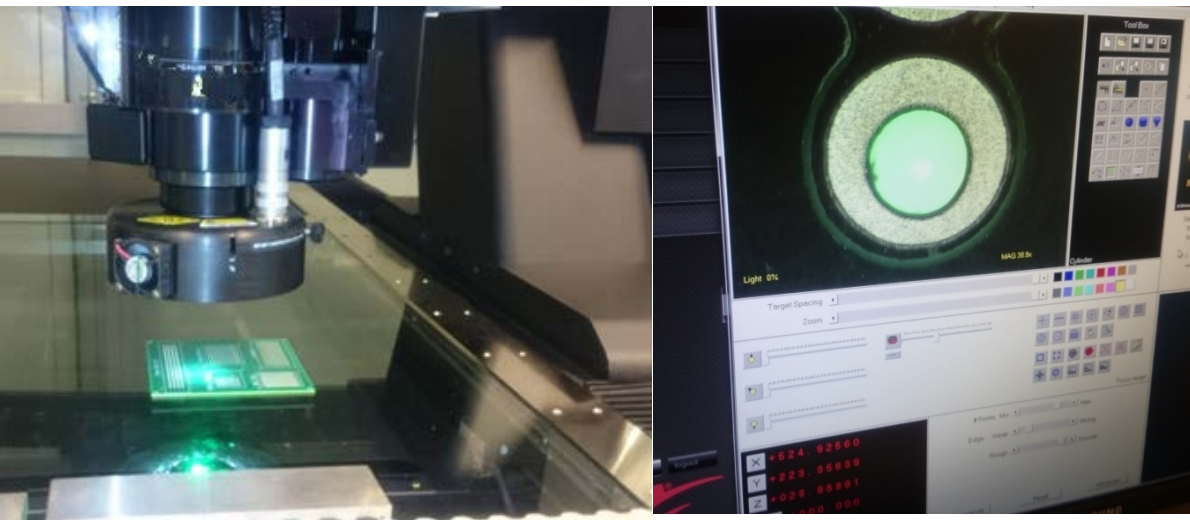

Correct hole sizes were obtained

- ENIG holes slightly bigger than ImSn holes (same drills used)

Insertion

- Original tooling received from connector vendors.
- Recommended process parameters were followed.



A

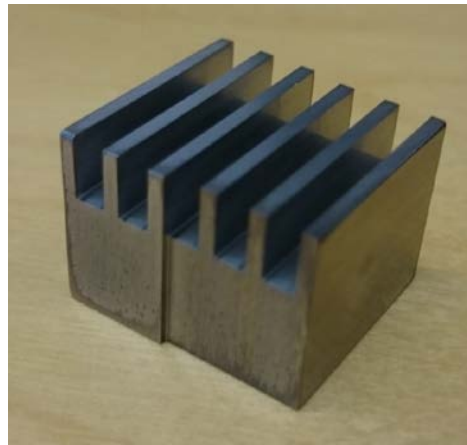

B

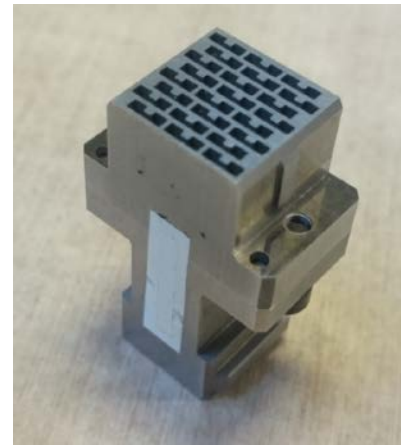

C

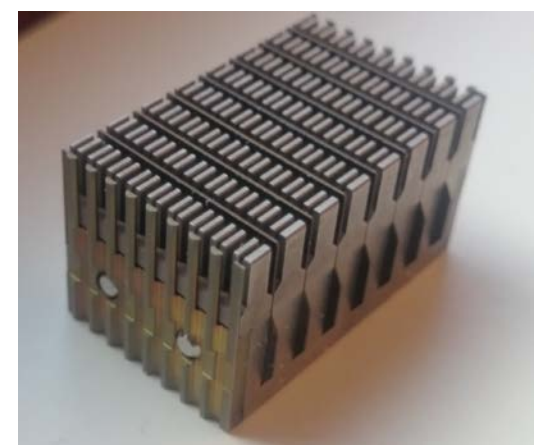

E

Insertion

- Two semi-automatic press in machines and one manual equipment used.
 - *Force, press in distance and time measured.*



Semi-automatic insertion, D

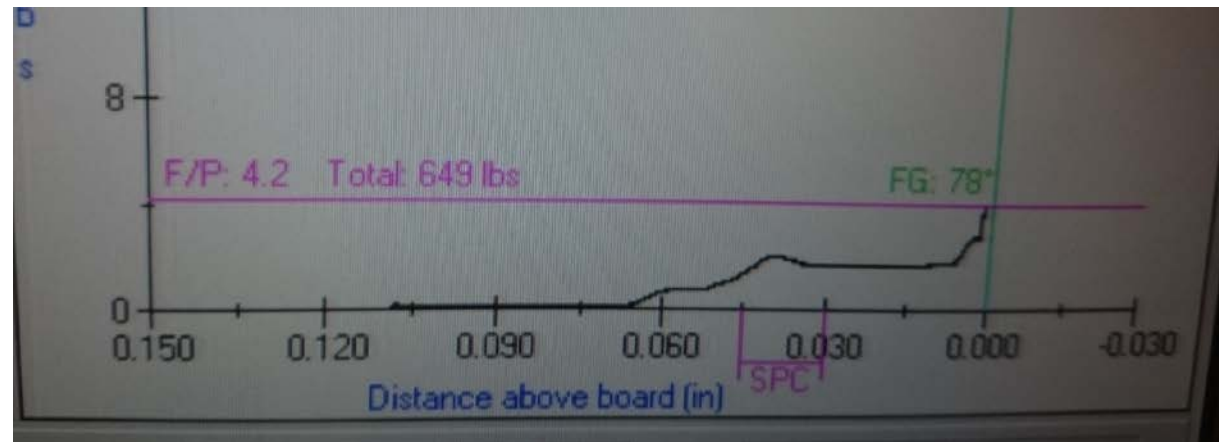

Force-time curve for connector C



Manual insertion, E

Removal

- Different techniques for removal.
 - *Recommended techniques.*
 - Except for connector A.

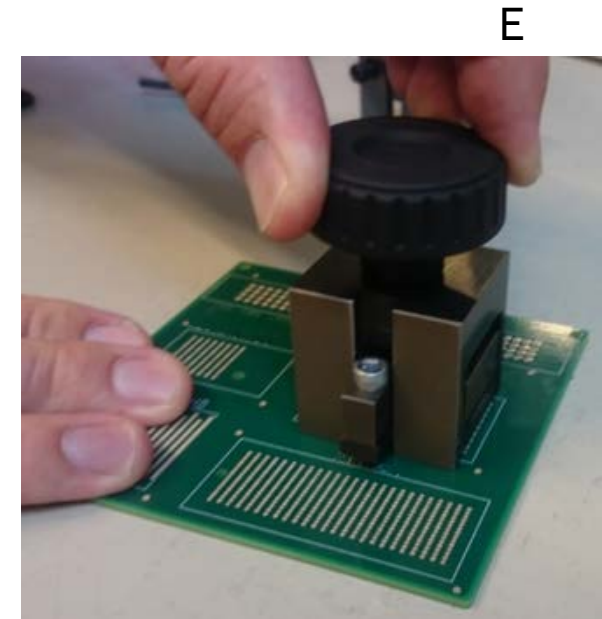
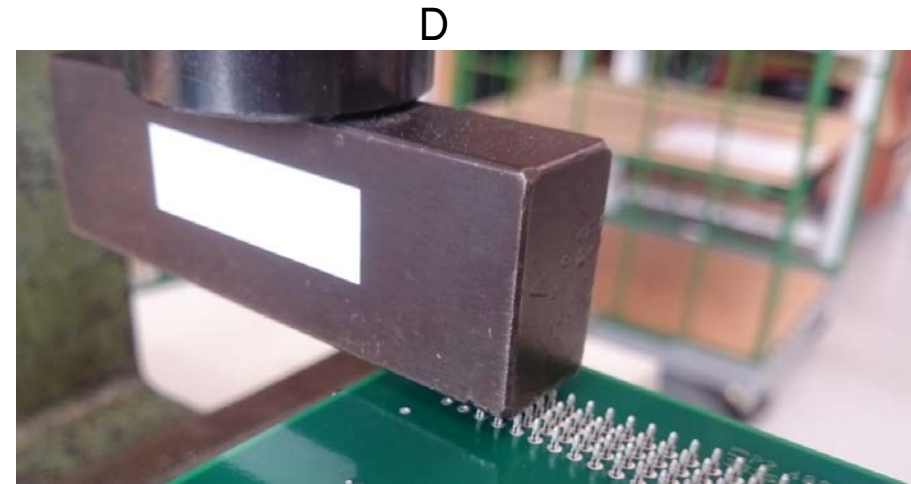
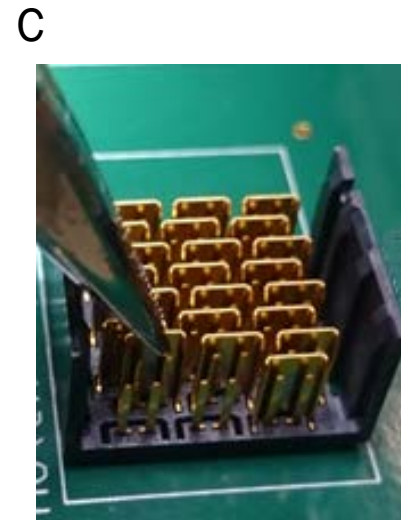
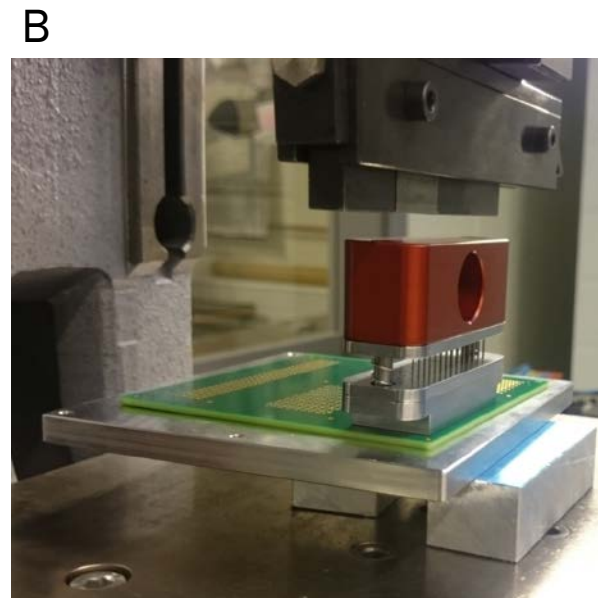
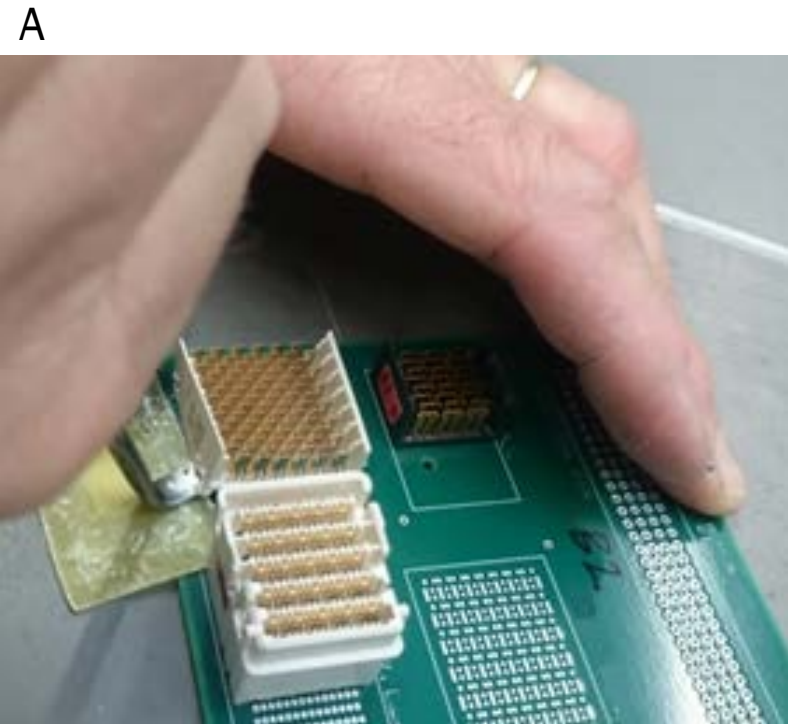

Single Pin Insertion and Retention Force Measurements

- 240 single pins of each type were used.
 - *40 insertion and retentions for each combination of hole plating (ImSn, ENIG) and hole size (min, nom, max).*

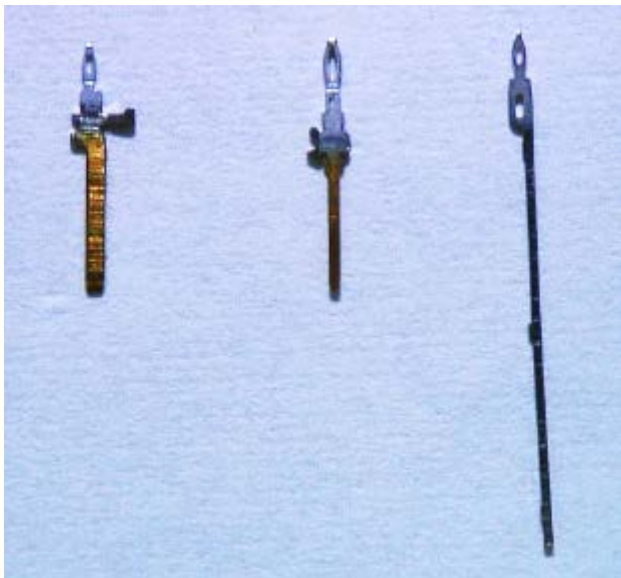

C

A

B



D



E

Single pin insertion and retention test

- Standard Telcordia GR-1217-CORE was followed:
 - *Insertion and retention speed 100 mm/s*
 - *Insertion depth 1.4 mm*
 - *Hold time 3 s*

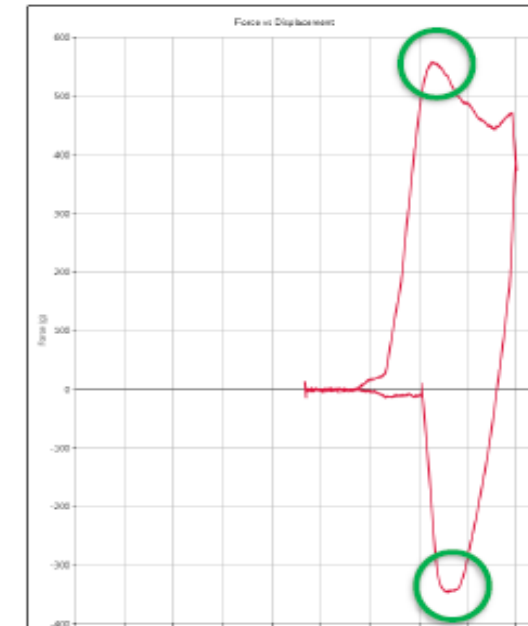
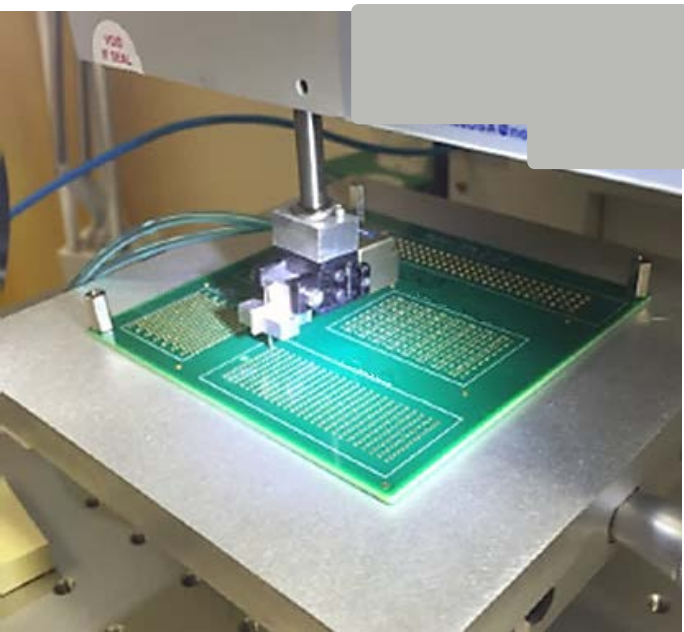

Design of Experiment (DoE)

- 5 different factors with 2 up to 5 levels.

Board Finish	Amount of Rework	Pin Type	Hole Size	Force Type
ImSn	0	A	Maximum	Insertion
ENIG	1	B	Nominal	Retention
-	2	C	Minimum	-
-	3	D	-	-
-	-	E	-	-

Insertion Test

- Interaction plot
 - *Fitted means*

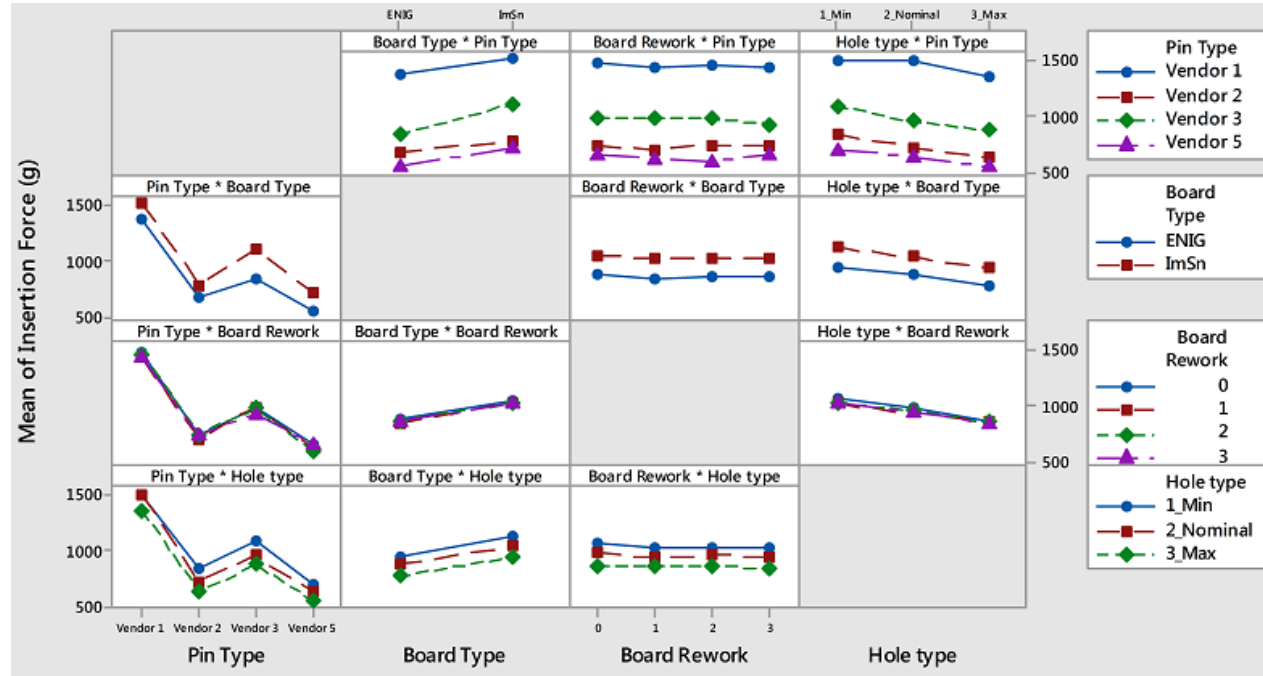

- Main effect plot

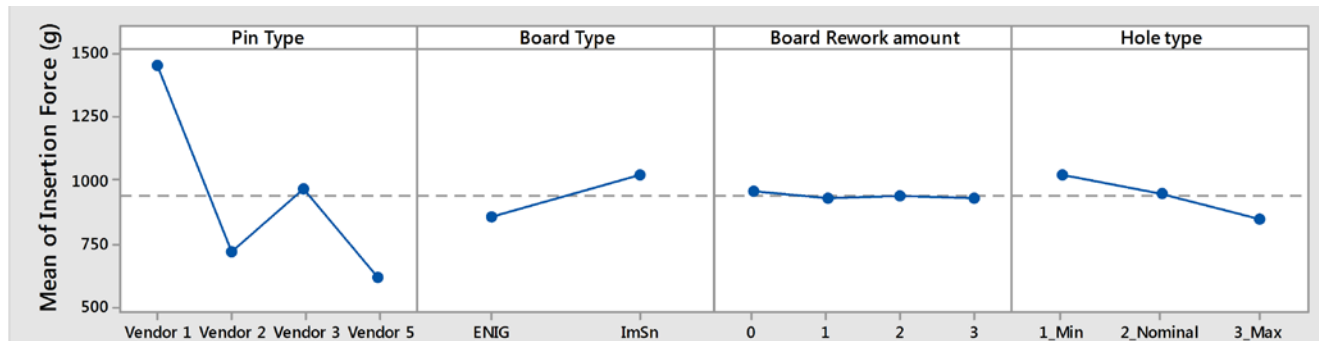

Retention Test

- Interaction plot
 - *Fitted means*

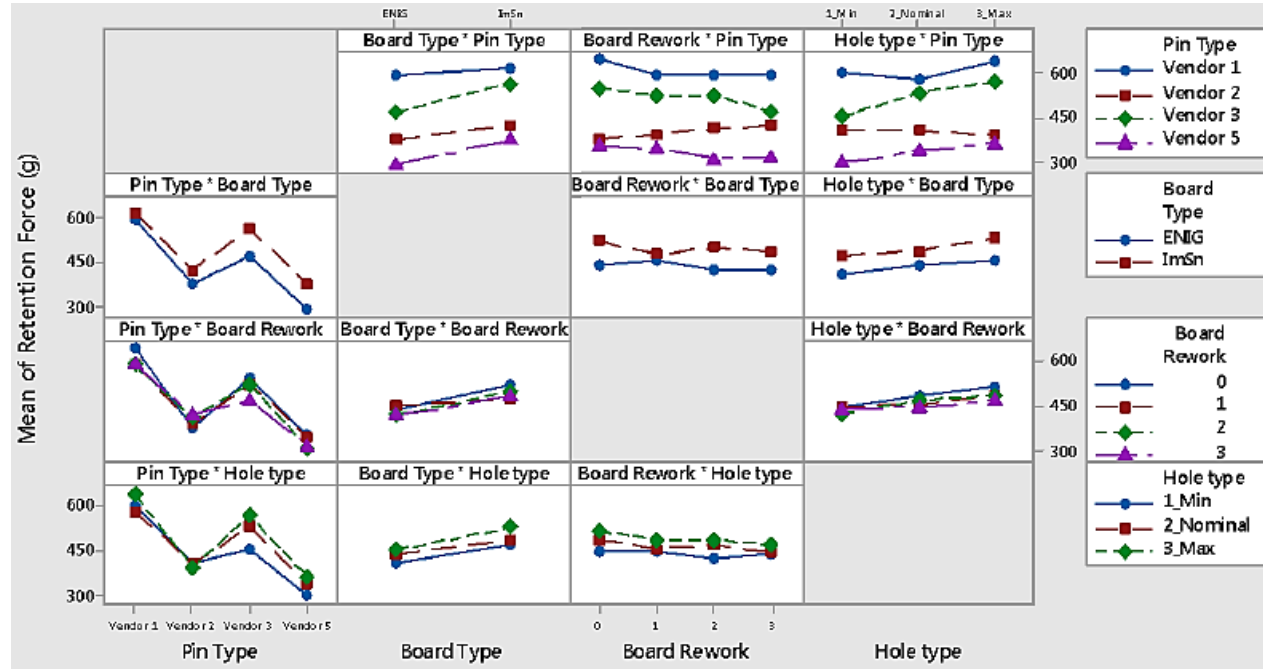

- Main effect plot

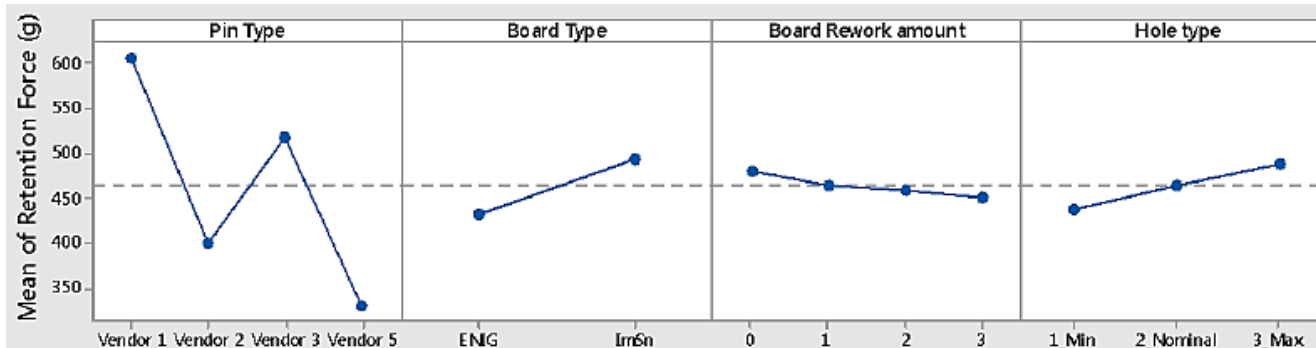

Insertion and Retention Test - Comments

- No significant difference in connection strength after multiple reworks.
- Pin size, material and pin geometries important as well as hole plating.
- Pin insertion:
 - *Highest force to insert pins into smallest holes, lower force for nominal holes and lowest force for maximum diameter holes.*
- Pin retention:
 - *Highest force for maximum holes size, followed by nominal and minimum hole size has lowest retention force (opposite result to pin insertion).*
- Pins damaged during insertion in smallest holes?

Gas Tightness Test

- Performed in order to investigate plating cracks or other damages in hole plating.
- Resistance measurements before and after storage in aggressive gases.
- 13 -14 pins measured for each combination of component, hole plating and hole size.
- Test according to EIA 364, test procedure 23.

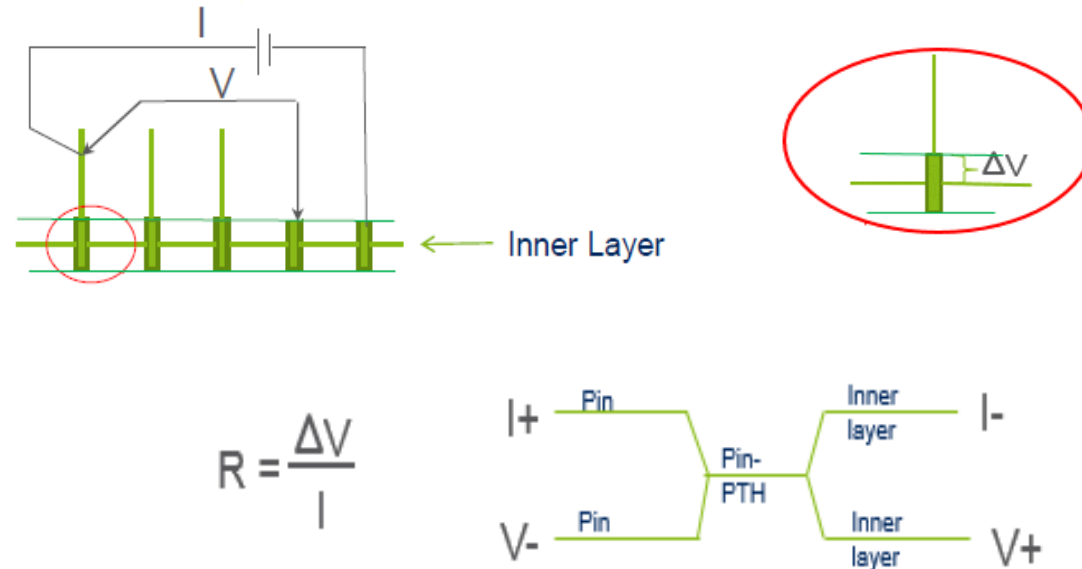
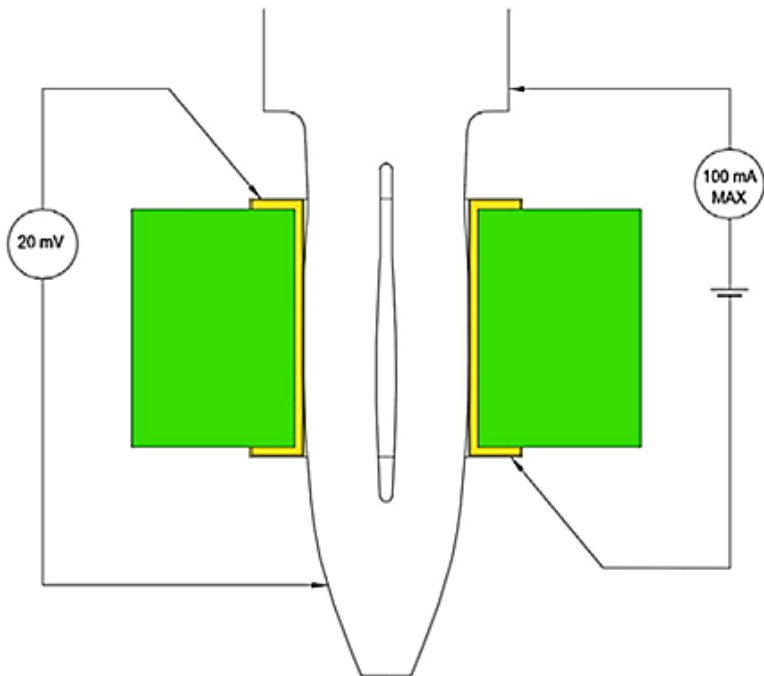

Gas Tightness Test

- Measurements:
 1. *Contact resistance measurement.*
 2. *One hour storage in saturated nitric acid.*
 3. *Re-measurement of contact resistance.*

- No significant change in resistance.
 - *Multiple rework had led to no, or to very little, hole damage.*



Samples inside test chamber saturated with nitric acid.

Cross Sectioning

- Cross sectioning performed so that whole row of pins could be inspected.
 - *Both for horizontal and vertical cross sectioning.*

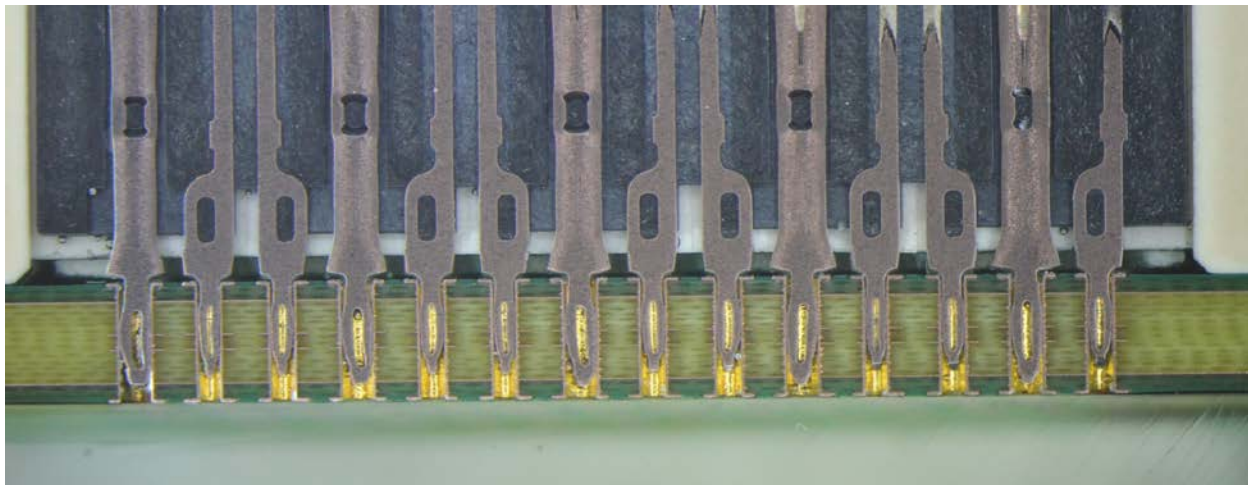

Connector B, vertical cross sectioning

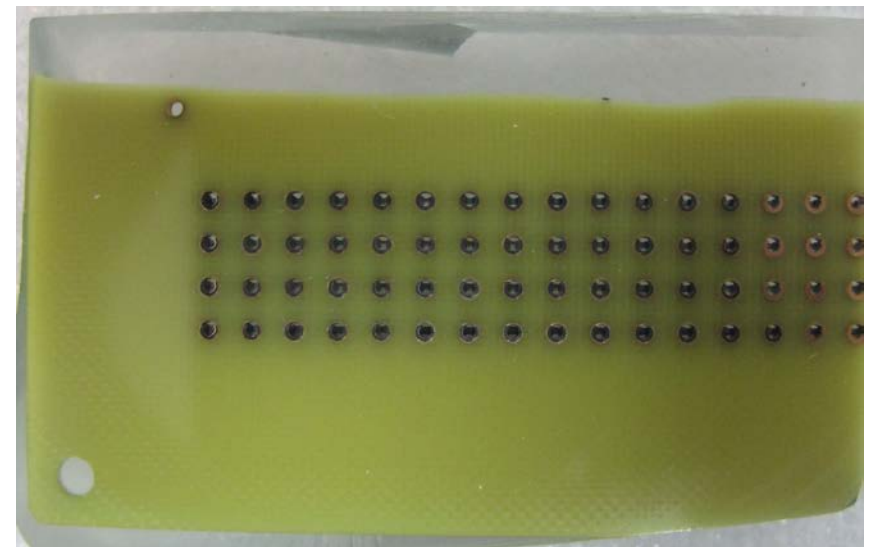

Connector D, horizontal cross sectioning

Cross Sectioning

- Proves that smallest hole diameters have permanently deformed needle eye pins.

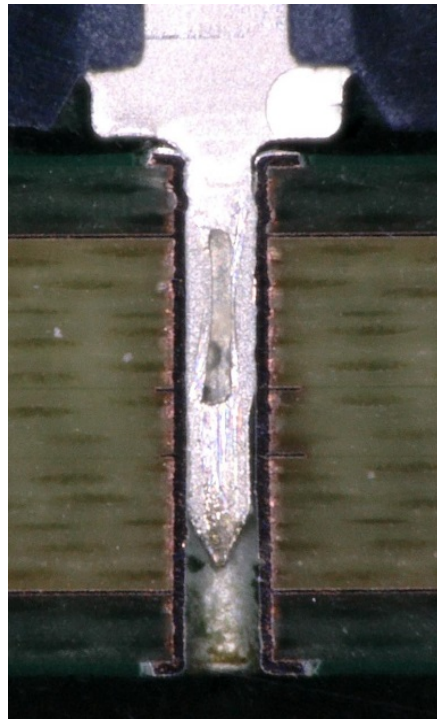
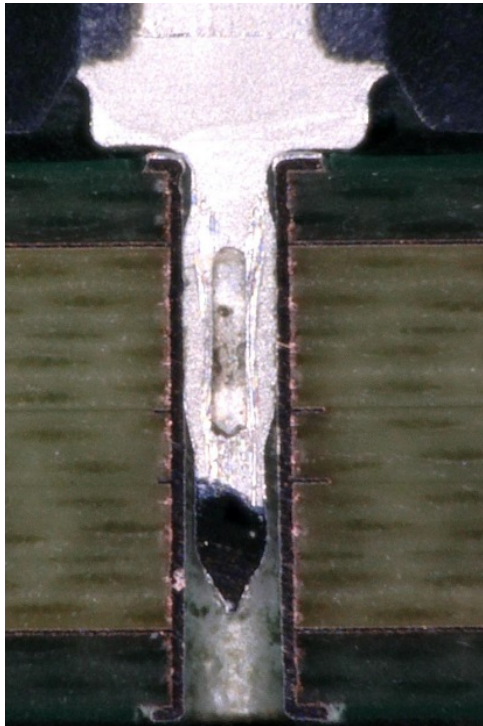

E, Max hole size (left), min (right)

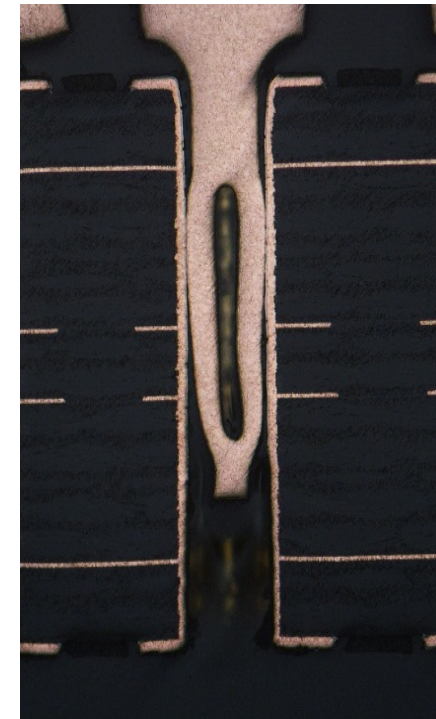
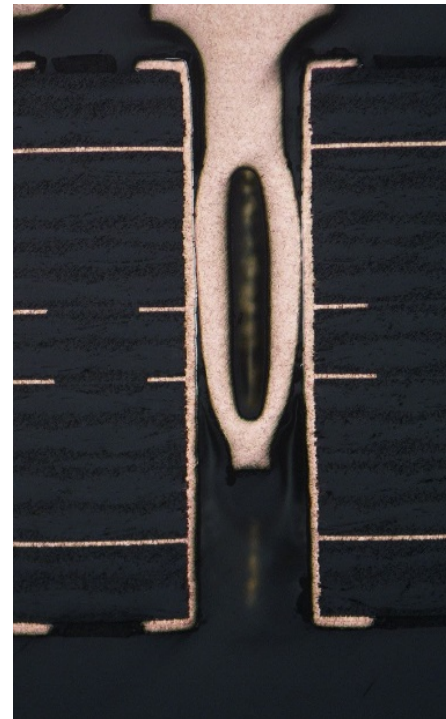

B, Max hole size (left), min (right)

Cross sectioning

- Many examples of permanently deformed pins in smallest holes!



E

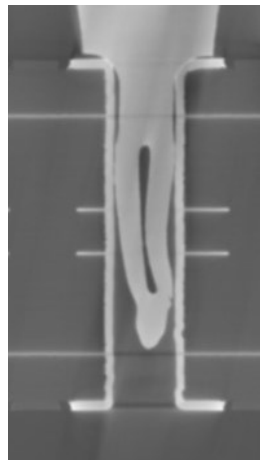

B

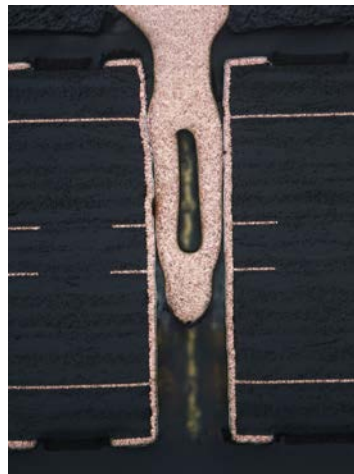

A

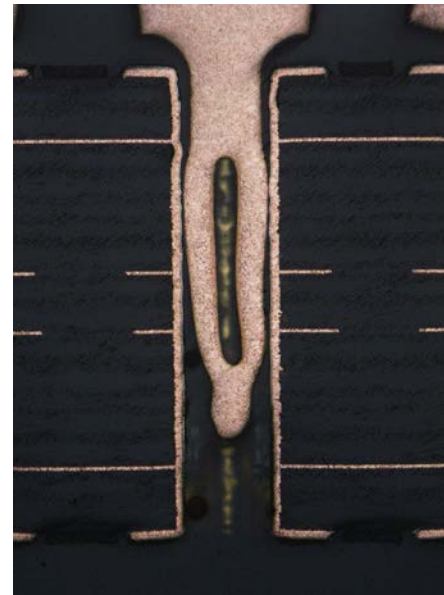

B

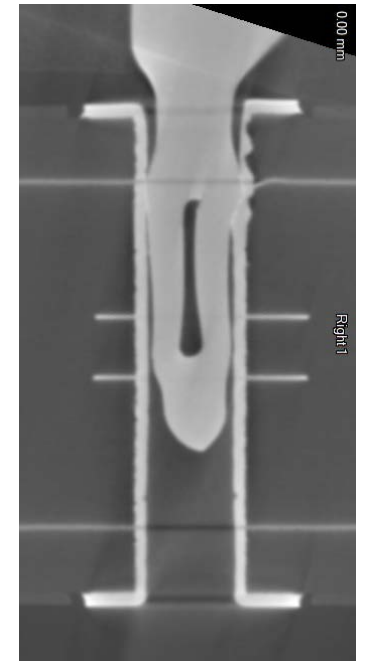

C

Cross sectioning

- Few and small hole damages – even after 3x rework.
- Actual contact surface area often rather small.

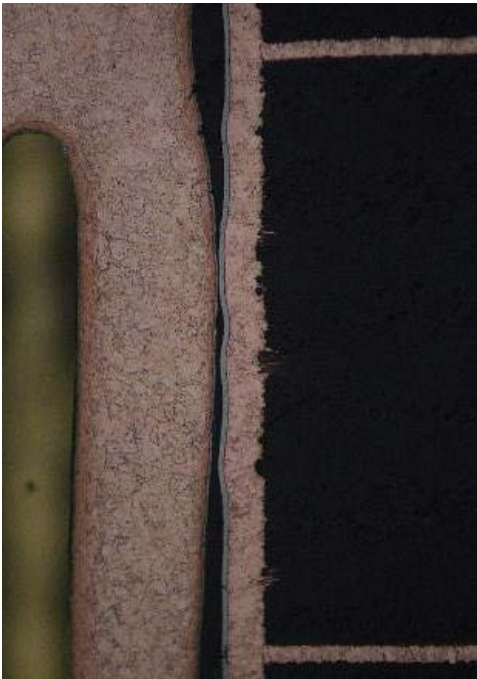

B

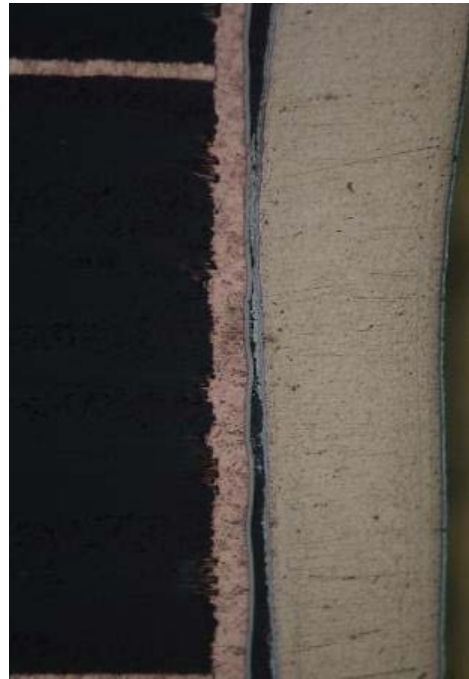

C



D



D

Cross Sectioning

- Horizontal cross sectioning – small deformations, nearly no damages.

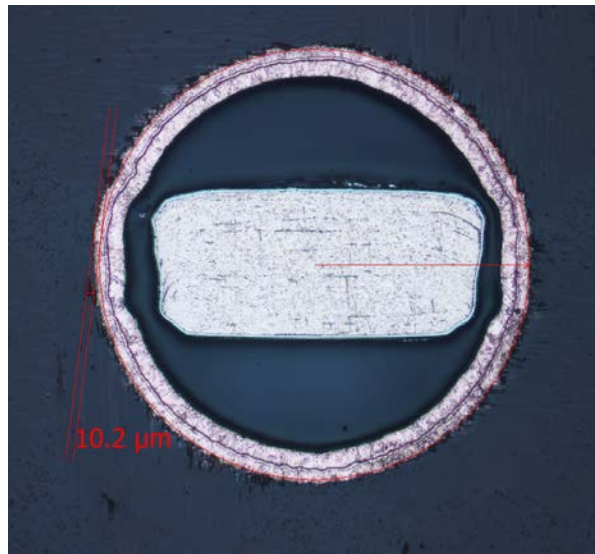

B, ImSn, 3x rework, min hole

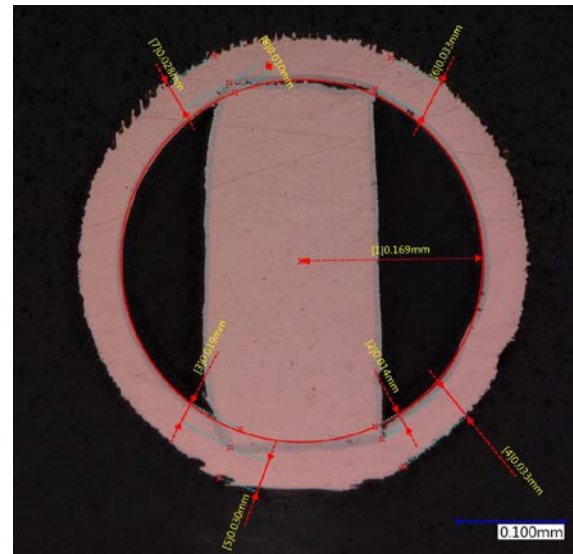

E, ENIG, 3x rework, min hole

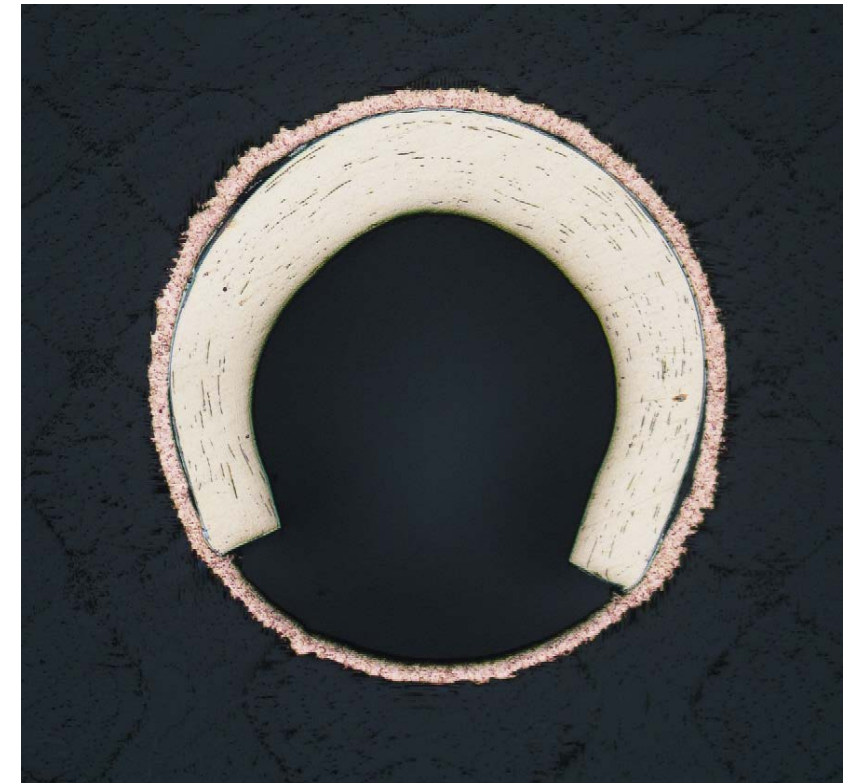

D, ImSn, 3x rework, min hole

Conclusions and Recommendations

- Multiple rework of new family of high speed press fit connectors have little or no effect on hole damage or connection strength.
- Connection strength dependent on pin size, materials, and geometries, hole size and hole plating. Reference connector D strongest connection followed by A, C, B and E.
- Insertion and retention forces higher for ImSn holes than for ENIG holes.
 - *Smaller holes sizes for ImSn holes compared to ENIG holes could be the reason.*
- High speed connector pins permanently plastic deformed when introduced in smallest holes.
 - *Lost elasticity gives lower pressure on hole wall, which gives less connection strength.*
 - *Recommended to increase lower hole size limits.*

Thank You for Listening!

Acknowledgements

The author is grateful to the following colleagues, HDP User Group members and supporters that have contributed to the development of methods, performed measurements and reviewed the paper:

Ceperi: Tao Lu, **Contech Research:** Tom Peel, **Ciena:** David Wice

Dell: Wallace Ables, Jacky Zhang, **Ericsson AB:** Anne-Kathrine Knoph, Marie Press, Benny Gustafson, Esmail Dastbaravardeh, Ove Isaksson, Torgny Dahl, Jesper Wittborn, Kjell Asp, Roland Westergren, Rolf Alexandersson, Binas Nisic

Erni: Bernd Eifer, **FCI:** Jeffrey Toran, John Thompson, Jim Kopec

Flex: Francoise Sarrazin, Dennis Willie, Kelvin Wong, Christopher Vu, Jie Lian, Christian Biederman, Wesley Tran, **Fujitsu:** Jordan Chaney, **HDP User Group:** John (Jack) Fisher

Molex: Zach Bradford, **Nokia:** Joe Smetana, **Oracle:** Karl Sauter, **Sanmina:** Doug Thomas

Tyco Electronics: Rickard Barrefelt, Per Nordström, Magnus Andersson, Doug Lawrence, Victor Torres