

Novel Probing Concepts for Mass-Production Tests: Design and Challenges

Matthias Zapatka, Dipl.-Ing.(FH) ; Otmar Fischer, Dipl.-Ing. (FH) ; Sven Nocher
INGUN Pruefmittelbau GmbH / RNS International, Inc.
Cupertino CA / Konstanz, Germany / Charlotte NC

Abstract

The world of spring-loaded test probes and special probes for in-circuit and functional tests have grown tremendously over the past few years. Ever increasing demands for electro mobility applications, the telecommunications market and the automotive sector force the manufacturers to think beyond the concepts of a traditional standard probe in order to meet the demands of today's highly complex test applications. In this paper, we like to demonstrate probing concepts for three different scenarios: (1) High speed probing for fast data rate applications, (2) high current probing for multi-probe-environments and finally (3) pneumatic probing for sequential probing applications and fixtureless installations. The challenge for all application areas but especially for high current and high frequency probes is to not only look at the mechanical properties of a test probe to successfully mate with the counterpart but to follow a holistic approach to combine high frequency behaviour etc. with mechanical aspects.

1 High current probing: Challenges for multi-probe installations

1.1 Correlation of current and test probe arrangement

High current can either be transferred with one large diameter test probe or with several smaller test probes which are installed in an array. The main disadvantage of a single test probe for high current transmission is that the front face of the probe's tip quite often does not have a full planar contact area with the device under test (e.g. due to placement inaccuracies or plunger position. If one chooses a solution with several probes it can usually be achieved that each single probe makes proper contact.

Figure 1 - Various kinds of transfer blocks, widely and commonly known as “pylon blocks” [ING10]

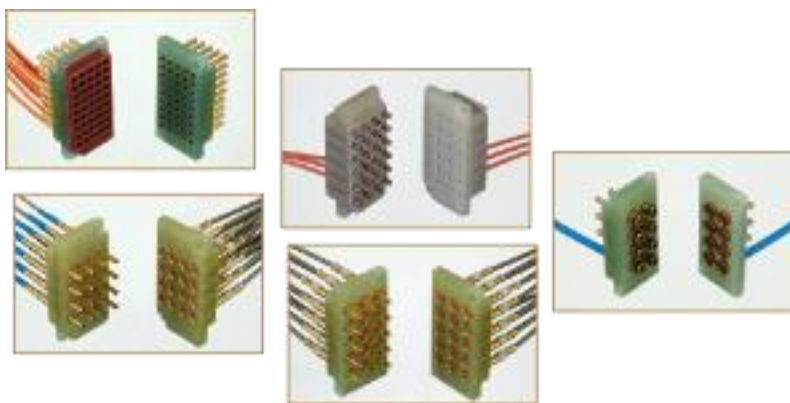

This report shows a thermal evaluation of the probe properties, based on theory of thermal distribution among closely spaced test probes.

A pylon interface block (which is commonly used by many manufacturers as a signal transmission block for test fixtures, see *Figure 1*) is used to demonstrate the thermal distribution. Such a block has a similar behaviour than a multi-probe high current probe.

If installed in a test fixture, it can generally be assumed that there is no wind, i.e. no convection (heat transfer due to air flow / cooling) takes place. However, as we see later a forced convection with cooling fans however might be necessary to cool down a transfer block unit – even when being driven with relatively low currents.

1.2 Single probe installation / high current probing basics

Test probe basics: As every electrical conductor, a test probe has a certain resistance. If current is applied, power dissipates and the probe heats up.

$$P = R \cdot I^2$$

Equation 1 - Power dissipation

Due to the surface area, the probe can dissipate a certain amount of heat. This depends on the temperature difference in relation to the ambient temperature. After a sufficient amount of time, equilibrium between dissipated power (temperature difference between probe temperature) and generated power (due to current flow) takes place.

A test probe can consist of several different base materials such as copper beryllium (BeCu) or steel and different plating materials. Consequently, the maximum permissible probe temperature varies from probe type to probe type. We have seen that the temperature is dependent on the current flow and thus a maximum current rating can be derived from several different parameters (probe diameter, probe base material, surrounding dielectric material, ambient conditions).

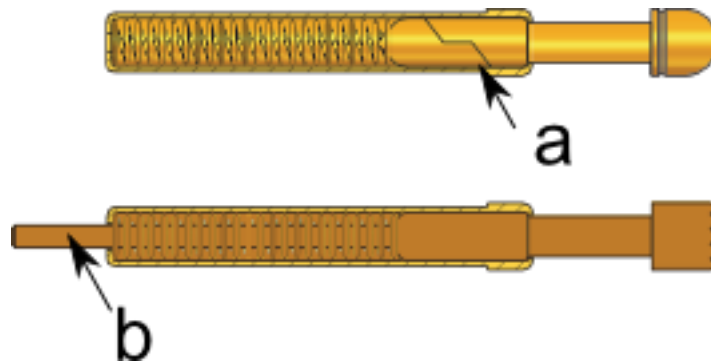

Figure 2 - Basic principles to lower the resistance of a high current probe [ING10]

There are several different test probe types on the market, some of which are specially made for high current applications. Those high current probes usually have a lower resistance than standard probe types, even if the outer dimensions sometimes look the same. Thus, a high current probe naturally has a higher current rating as a standard probe to heat up to the same degree as a standard probe with the same form factor.

Figure 2 shows some basic design principles to increase the current rating of a spring loaded test probe. To decrease the resistance, a continuous plunger can be used (a). To increase the surface area, a two-piece blade structure can be used for the plunger. With movement towards the working position, the two part plunger “unfolds” and is pressed against the barrel. This concept provides a large contact area which increases the current capacity in comparison to a standard probe without this feature.

1.3 Multi probe installation

The situation becomes much more complex if not only one probe is driven with a certain current but if several probes are installed next to each other. If the spacing is small enough, the probes thermally interact with each other. One probe heats up

the adjacent probe (heat accumulation). Thus, the other probe “sees” a higher temperature. When current is applied, this probe heats up even more, because energy dissipation only occurs in dependence with the temperature difference. The “total surface area” is smaller and hence less heat can be dissipated. The end temperature of the probe thus would be higher. As a consequence, the probes must be used with less current.

The farther the distance between the probes is, the better the heat dissipation - and the current rating per probe can be higher. The critical distance between the probes can be evaluated with formulae from the field of thermodynamics (heat radiation, convection and heat conduction) and electrical part (power, resistance). In addition, measurements can be used to verify the theoretical approach.

Table 1 shows the relative heat distribution as described in the text. Please note that all further comparisons in this paper are mostly given with relative values.

Table 1 - Heat accumulation for various probe installations

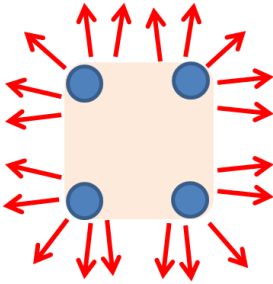
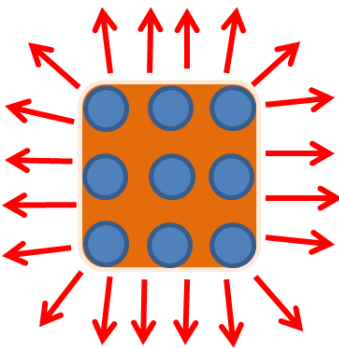
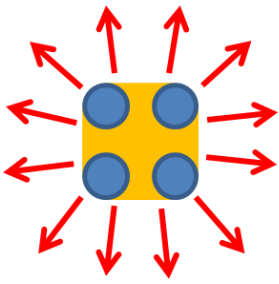
		
<p>Case (a): The distance between the probes is large enough. Heat can easily dissipate</p>	<p>Case (b): The distance between the probes is too small. Heat accumulates.</p>	<p>Case (c): Moderate heat accumulation, same pitch as in (b) but fewer probes. Better dissipation.</p>

1.4 Comparison / measurements

Several measurements have been taken to demonstrate the correlation between probe installation and generated heat. The temperature test point for the measurements is the probe that is located in the middle of the array to demonstrate the “worst case scenario”.

1.4.1 Simulations and measurements for a constant area or a constant pitch

For both case 1 (constant area) and case 2 (constant pitch), a 170 pin transfer block (outer dimensions approx. 5 cm x 3 cm) is used as the “nominal block” and all other values are derived from that. For case 1, the outer dimensions of the block stay the same but the number of probes is reduced. For case 2, the “nominal pitch” of the 170 pin block (which for this evaluation is 2.54 mm / 100 mil) stays the same but the outer dimension of the block is reduced accordingly.

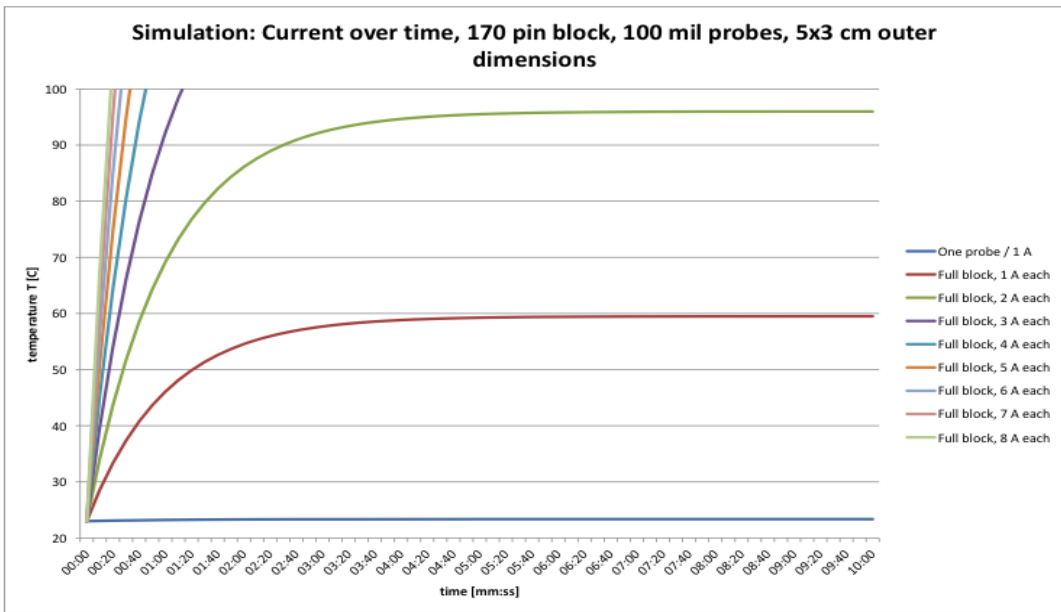

Figure 3 - Simulated heat over time for a 170 pin config. transfer block

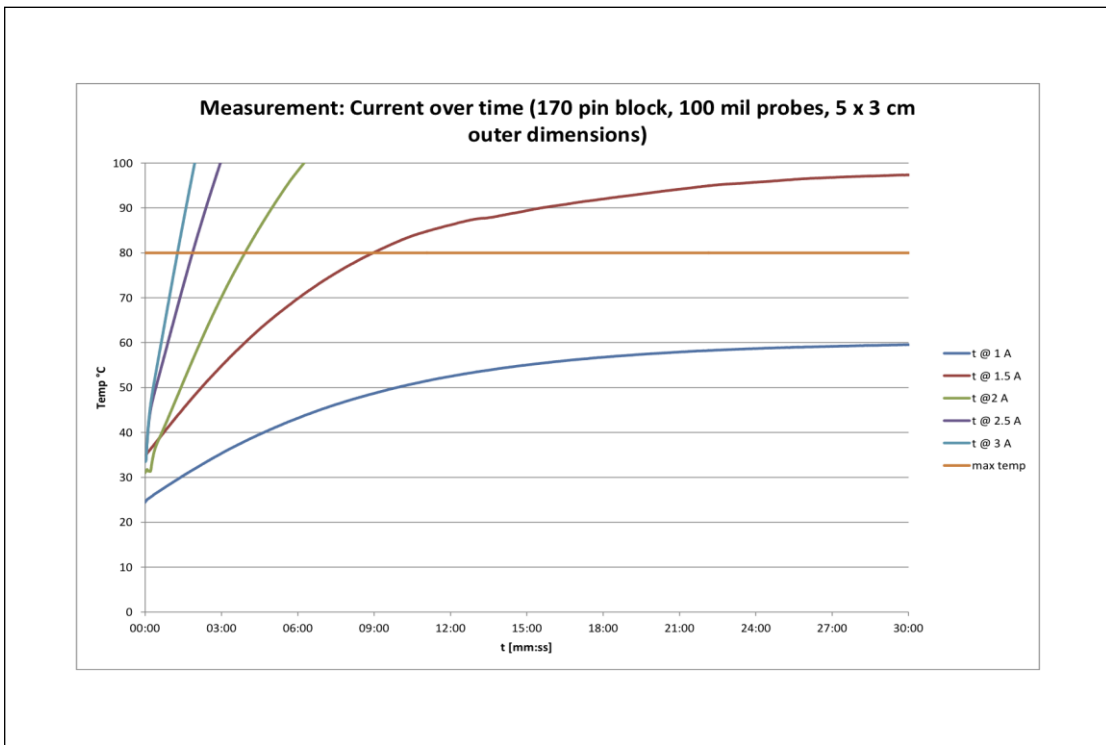

Figure 4 - Measured heat over time for a 170 pin config. transfer block

Figure 3 and 4 are a good demonstration that even for small currents below 5 A the transfer block can overheat easily if all 170 probes are driven with the current. For all further evaluations and measurements, the most critical point at the probe has been used to detect the temperature. In our case this would be the point where the probe's plunger comes in contact with the barrel (at working stroke). The 170 pin block does not come in a "real" high current probe version (a real high current probe design is shown in Figure 2).

When being brought to the working position, the plunger deflects slightly and touches the barrel at the front part and somewhere in the middle (at the point where the tail part comes in contact with the spring, see *Figure 5*). At this point, the thermocouple element is attached. An automated PXI system is used to acquire the temperature measurements and to drive the current. A photo of the test setup inside a test fixture is shown in *Figure 6*.

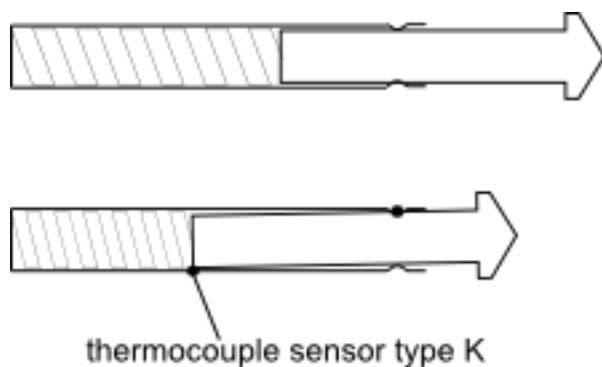

Figure 5 - Measurement point for the thermocoupler

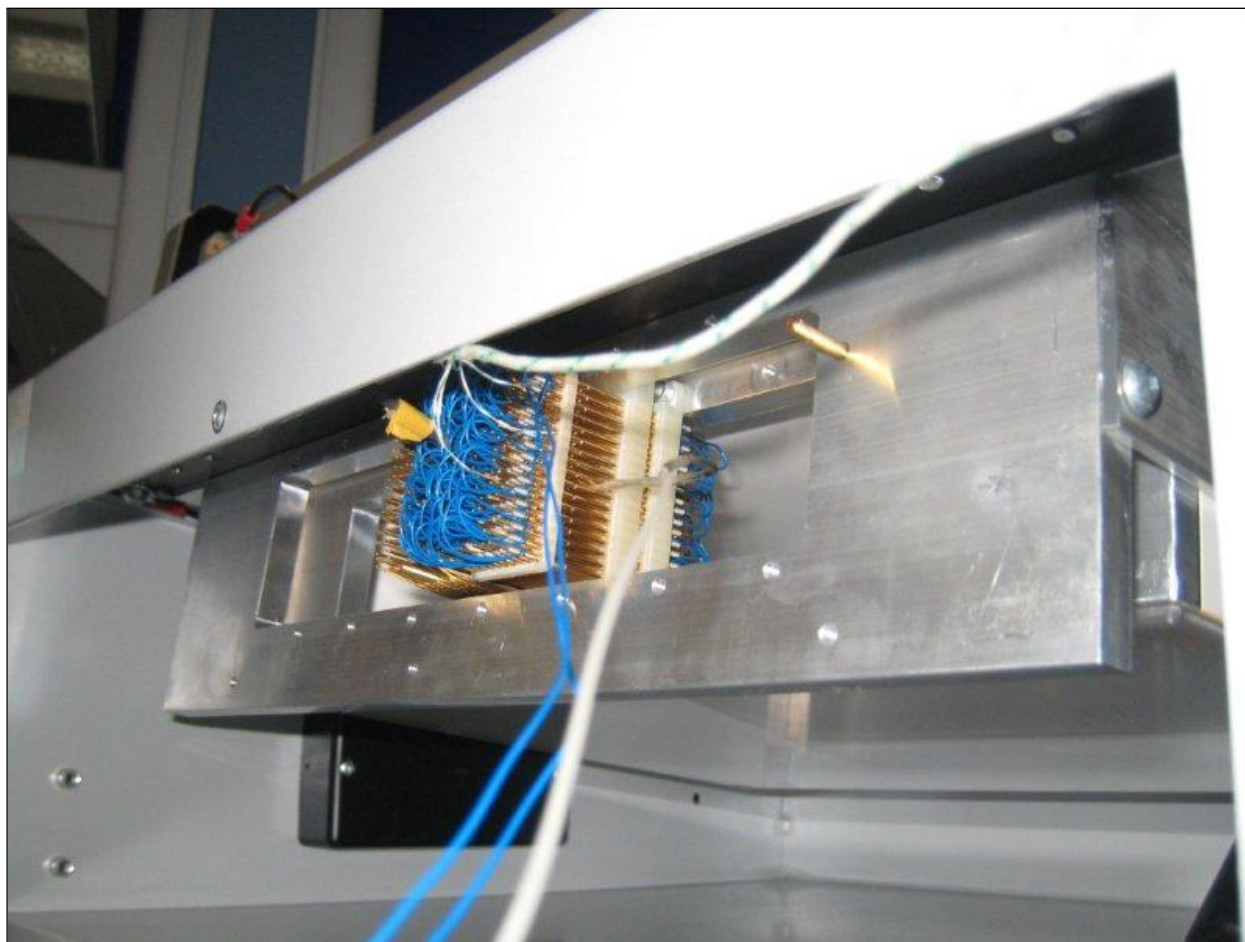
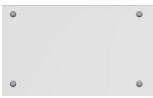

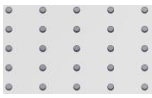
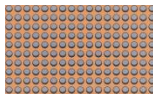

Figure 6 - Interface blocks installed in a regular mechanical test fixture with attached thermocouple sensor

Case 1: Constant area

Table 2 – Multi-probe installation with constant area

			
2 x 2	3 x 3	5 x 5	10 x 17 (3 x 5 cm = outer dimension)

The more probes are installed in a constant area (see *Table 2*), the lower the pitch between two probes is. The measurement shows that the generated heat for 1, 4 and 9 probes that the distance between the probes is still large enough because the thermal interaction between the probes is neglect able ($\Delta T = \text{small}$). A 25 pin configuration shows a temperature increase of 10 K @ 1 A. A 170 pin configuration (fully assembled “pylon” transfer block for test fixtures) shows an increase of 50 K (!) (see *Figure 7*). The current would need to be decreased dramatically to lower the temperature.

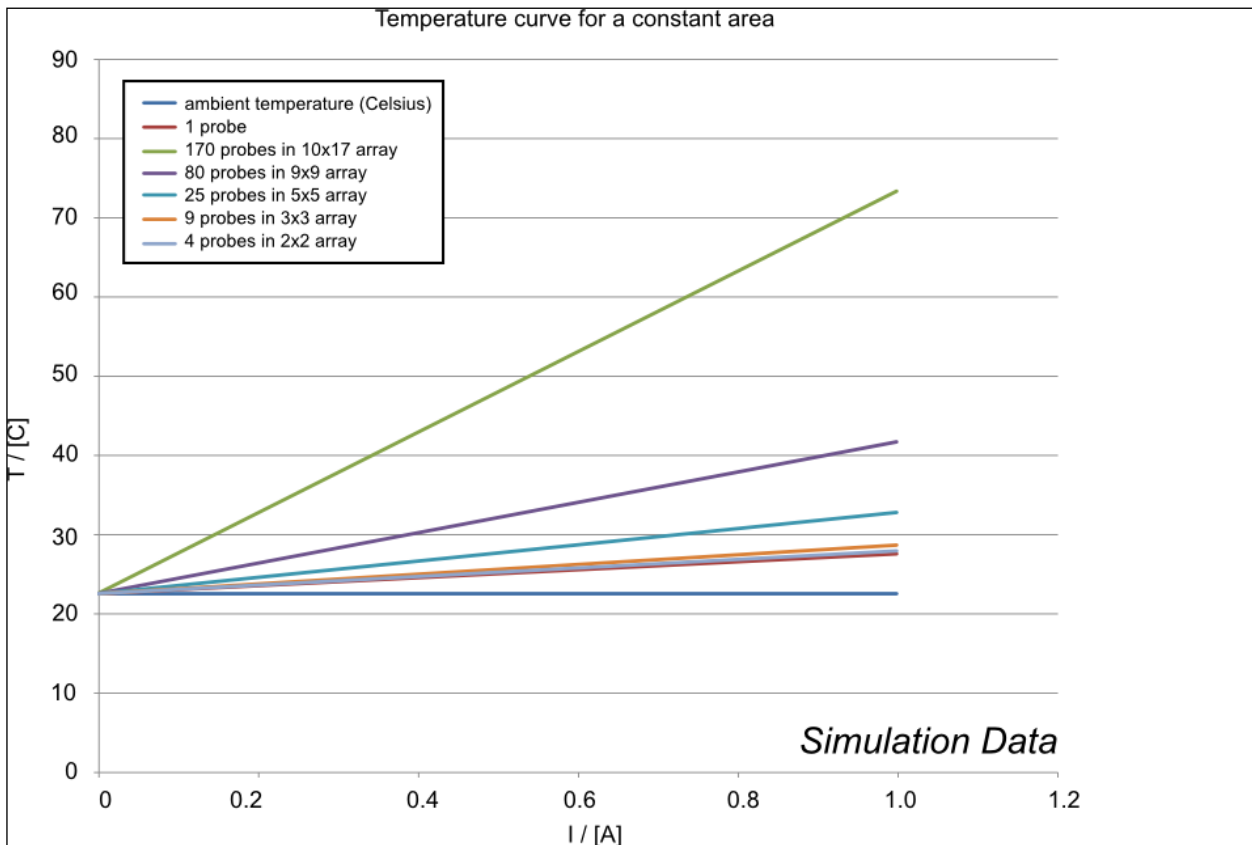



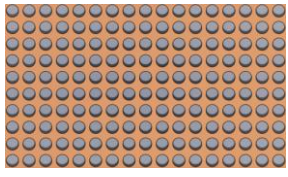

Figure 7 - Temperature (1 probe) for a constant area

Case 2: Constant pitch between probes

Table 3 - Multiprobe installation with constant pitch

			
2 x 2	3 x 3	5 x 5	10 x 17 (3 x 5 cm = outer dimension)

The pitch between the probes is constant (*Table 3*) but the area is increased the more probes are installed. Even a 2 x 2 configuration shows a delta T of 25 K @ 1 A current (*Figure 8*).

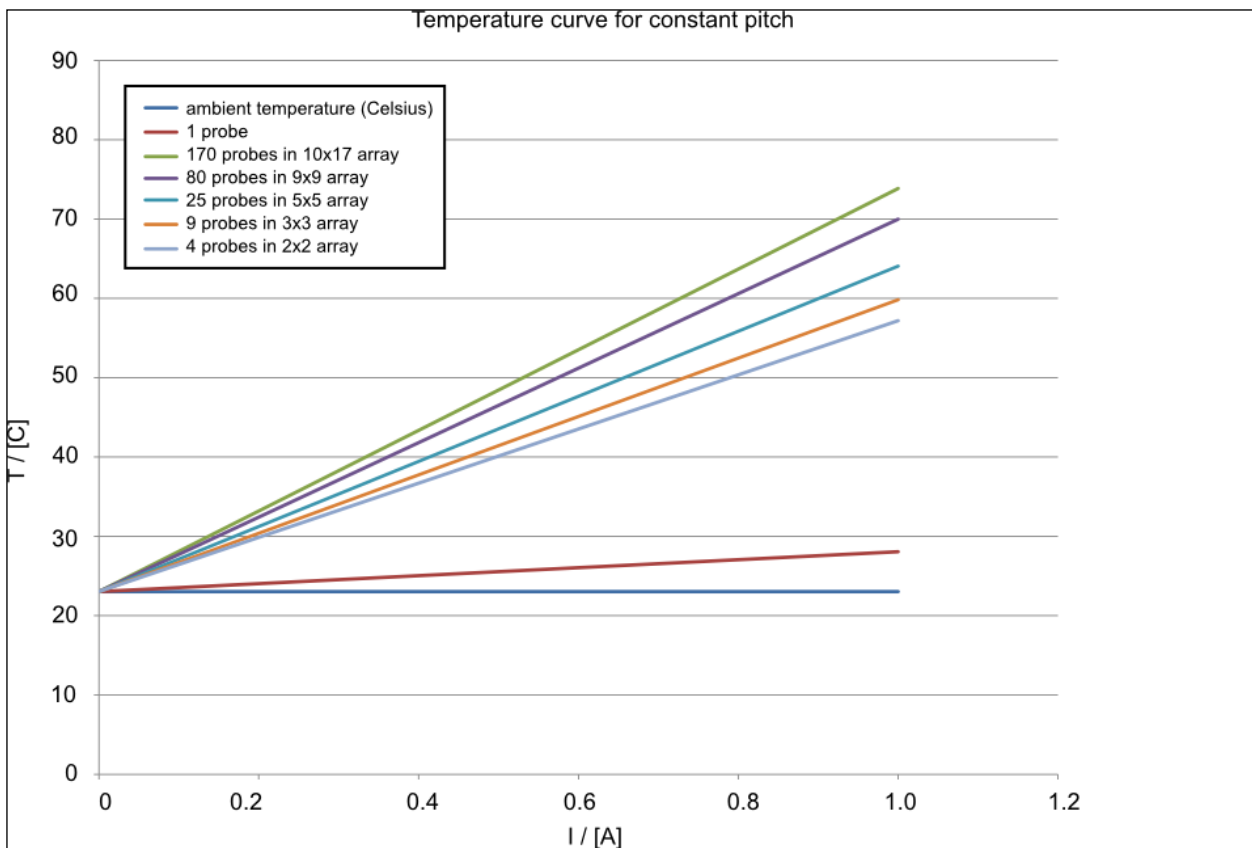

Figure 8 - Temperature (1 probe) for a constant pitch

1.5 Methods to reduce the heat

Figures 7 and 8 provide a good illustration to see what happens if the spacing between two probes is too small or the applied current is too high. *Figure 4* shows the temperature rise for a test probe with 1.37 mm outer diameter for various currents over time. It can be clearly seen that the maximum temperature of 80 degrees Celsius (specified by the manufacturer) is reached pretty rapidly when applying to many Amps. Taking the delta values from *Figure 7 and 8* one can make further calculations to see whether a 2x2, 3x3 or 9x9 configuration would work if all probes are used with this current. Most likely one would need to decrease the current to 5 A or less to have enough buffer in order not to exceed the maximum allowed temperature.

Such time - temperature diagrams for various current ratings are available from most probe manufacturers worldwide (usually for a single probe installation). We encourage the readers to study them before implementing their test strategy. Ask the vendors to perform a measurement for a multi-probe installation with a higher current or use the ideas from this paper to make an estimate whether a multi-probe installation might work without overheating.

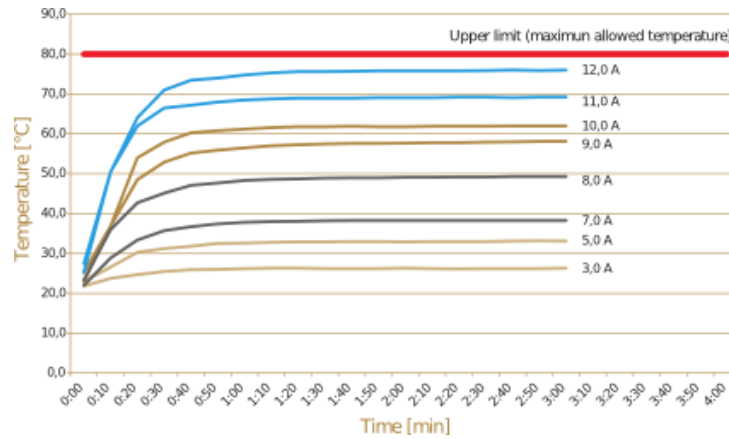

Figure 9 - Time / heat diagram (sample diagram) for various currents [ING10]

Three methods can be used to reduce the current:

1. reducing the current
2. increasing the pitch between probes
3. cooling the contact block

Methods 1. and 2. are quite often not very practical because the pitch between two probes is often given per the test point definition of the DUT and the applied current is given by the test procedures. Thus a cooling system (such as air vents, cooling fans) is the most effective way to bring down the temperature and to increase the current rating (forced convection).

It has to be noted that overheating not only leads to a deterioration of the probe's lifetime but more dangerously overheating bears the risk of fires etc. Although 80C is a conservative approach to specify the heat limitation it's better to be cautious than to create a safety hazard. On the flipside, the data can of course also be used to equally distribute the current over more probes (the original idea - as mentioned in the introductory paragraph of Section 1.1).

2 Novel probe designs and methods for high speed digital applications

2.1 Background

With the exponential increase of entertainment systems and other electronic devices that require high data transmission rates, the number of implemented data connectors grows exponentially - and thus the test and qualification process to ensure the proper functionality of such a component becomes more and more complex.

Not only do the manufactures of test systems and software face more and more stringent regulations on how the units are to be tested but also the manufacturers of passive transmission lines and probing solutions are required to put more emphasis on their mechanical design process in order to properly qualify the test product.

Going back 10 years, the manufacturers of test fixtures and test probes only had to deal with relatively low data rates in the lower MBit/s range and terms like signal integrity and stabilized differential impedance did not seem to have a big impact on the production line test process. Virtually any kind of spring probe could be used to qualify a product, because the mechanical properties and the shape did not have a big influence on the signal transmission. This has totally changed with the implementation of the first 1 / 10 and more GBit/s devices a few years ago.

Suddenly, the mechanical length and other dimensions *did* matter and e.g. the knowledge of the dielectric properties of the carrier plate became vital in order to estimate electrical properties such as the overall impedance behavior.

2.2 DUT overview and probing solutions

The DUTs for the presented probing solutions are mainly high-speed components from the telecommunication or automotive industry with industry-standard data connectors such as HSD or MX49, all the variants of the common USB2.0 connectors and several other data connectors. The scope is to perform a functional test with these components in the shortest possible time, because, after all, we are talking about a mass-production high volume test environment (production-line).

The idea is not to use the “real” counterpart as the contacting solution, because such a mating connector is not made for high throughput test applications and would wear off quite rapidly.

To state a figure, most coaxial RF connectors have mating cycles in the 100-500 cycle range (depending on the connection mechanism, e.g. snap-in, threaded connection etc. - as a reference, see the connector data sheets from various manufacturers, e.g. [HUB07]). Thus, spring-loaded contacting solutions are the best choice because the probing solution is expected to have a longevity in the upper five-digit and up to the six-digit contacting cycle range before the probe needs to be replaced.

Without putting emphasis on the mechanical properties and installation of the probes, however, the signal transmission would greatly deteriorate and in the worst case the probe itself could influence the test result in such a negative way that even a faultless fully-functional board could not pass the test.

To summarize the problem: If the nominal differential impedance between two signal conductors is 100 Ω , the probing solution should stay in the same range (plus / minus a certain allowed deviation, which will be discussed later) in order to meet the specifications of the compliance test.

A fully assembled test station consists of various transmission line devices for the signal acquisition. Apart from the probe, one needs several cables, interface blocks etc. We first describe the theory for designing a two-conductor transmission line with defined impedance - this concept is then applied to an interface block and is later used for the design of the test probe which directly mates with the desired connector. If the DUT is not a connector but a land-pattern on a PCB that has to be contacted, the same principles apply, however one has to pay careful attention to the transition zone from the probe to the planar transmission line - the theory behind this optimization procedure however shall not be subject of this introductory paper.

2.3 Requirements in regards to the mechanical length of two signal conductors

Given shall be two spring-loaded probes with an attached twisted-pair cable. It now shall be illustrated what the influence of a non-ideal mounting and soldering procedure is. Let us assume that one string is 5 mm shorter than the other (e.g. due to the soldering process or improper cutting of the cable). To simplify the calculation, the impedance behavior along the line shall be homogeneous and have a value of 100 Ω . The dielectric material shall be Teflon. A total length deviation of 5/10 of a centimeter does not sound much, but the phase-error can be significant and contribute to degradation of the signal quality. The calculation is made for the fundamental (sine) frequency of a 480 MBit/s USB2.0 data signal ($f_0 = 240$ MHz).

$$vf = \frac{1}{\sqrt{\epsilon_r}}$$

Equation 2 - Velocity Factor

$$vf = \frac{1}{\epsilon_r}; \lambda = \frac{c_0 \cdot vf}{f}$$
$$\lambda = \frac{c_0 \cdot .69}{240 \text{ MHz}} \approx .8626 \text{ m}$$

Equation 3 - Wavelength

$$\Delta l = 5 \text{ mm}$$

$$\alpha = \frac{(\lambda - \Delta l) \cdot 360}{\lambda}$$

$$\Delta\alpha = \frac{(.8626 \text{ m} - 5 \cdot 10^{-3} \text{ m}) \cdot 360^\circ}{.8626 \text{ m}}$$

$$\Delta\alpha = 360^\circ - \alpha$$

$$\Delta\alpha \approx 2.09^\circ$$

Equation 4 - Phase difference for a line-length deviation of 5 mm

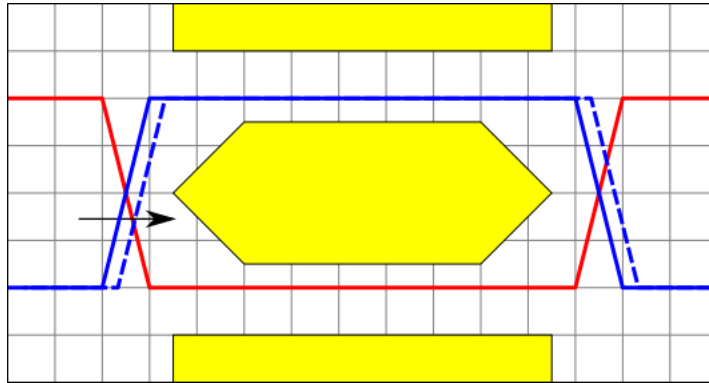

Figure 10 - Eye pattern degradation due to phase error / skew in the inverted signal

According to *Equations 2 - 4*, a deviation of just 5 mm in the length of a cable and the probe contributes to over 2 degrees of phase-error. Again, this does not sound much but it has to be kept in mind that this (avoidable) difference is just one factor that contributes to the overall jitter and skew behavior. Jitter and skew are main factors which degrade the eye opening of the mask.

2.4 Recommendations to maintain high signal integrity when customizing a fixture

- Don't use consumer-grade cables, instead use premium grade cables with high phase stability.
- Use proper crimping tools if necessary.
- When cutting the cable, pay attention to maintain the same length for both D+ and D- lines.
- The same applies to the soldering process.
- Avoid high side-loads in the test fixture which could create unequal probe lengths for D+ and D-.
- Optimize the dielectric carrier plate material to maintain the nominal impedance.

2.5 Using standard spring probes for high-speed data transmission

Basic equations to estimate the impedance behavior:

$$Z_{\text{diff}} = \frac{120}{\sqrt{\epsilon_r}} \cdot \text{arcosh} \left(\frac{D}{d} \right)$$

$$Z_{\text{diff}} = \frac{120}{\sqrt{\epsilon_r}} \cdot \ln \left(\frac{D}{d} + \sqrt{\left(\frac{D}{d} \right)^2 - 1} \right)$$

Equation 5 - Differential impedance between two conductors

The impedance between two conductors is given as an inverse-hyperbolic area-function. Thus to be easily accessible with a standard calculator it has to be converted to a standard logarithmic function. *Equation 5* shows the formulae for a two-

conductor configuration with surrounding dielectric material. For D/d ratios greater than 2.5 the latter part of the \ln -argument (the square root) can be usually skipped with only minor inaccuracies. An equation without the latter part of the argument is usually given by the manufacturers as “the” standard equation to derive the impedance behavior of a twisted pair transmission line (refer to [MAN12] or [HUB06] for details). By using *Equation 5*, one can easily approximate how two spring-loaded test probes need to be placed next to each other to acquire the desired impedance (and which dielectric carrier plate material needs to be used).

In a non-coupled transmission line pair, the differential impedance is usually twice the single-ended impedance. However it has to be said, that even under the best circumstances the coupling between two lines can never be reduced to zero. In addition, if one is working in a non-shielded environment (an open two test-probe configuration presents such a non-shielded state), a certain amount of field-coupled stray emissions (electrical noise, spikes) can enter the system and interfere with the transmission line.

Now, let’s prove that the analytical approach to use the formulae from *Equation 5* is a good start to design the probing structure for the transmission line. To do so, we take a standardized so-called Pylon block. Those Pylon blocks are available from many manufacturers worldwide and are available in different configurations. The one we are using for our evaluation has 170 spring probes and a current rating of 4 A. The further important mechanical specifications are as follows: The carrier plate material is FR4 with a dielectric of 4.1 (dispersion leads to a slightly lower ϵ_r value for frequencies in the upper MHz - GHz range). The receptacle’s outer diameter is $d = 1.67$ mm and the center-center spacing is $D = 100$ mil / 2.54 mm. The measurement setup is shown in *Figure 11*.

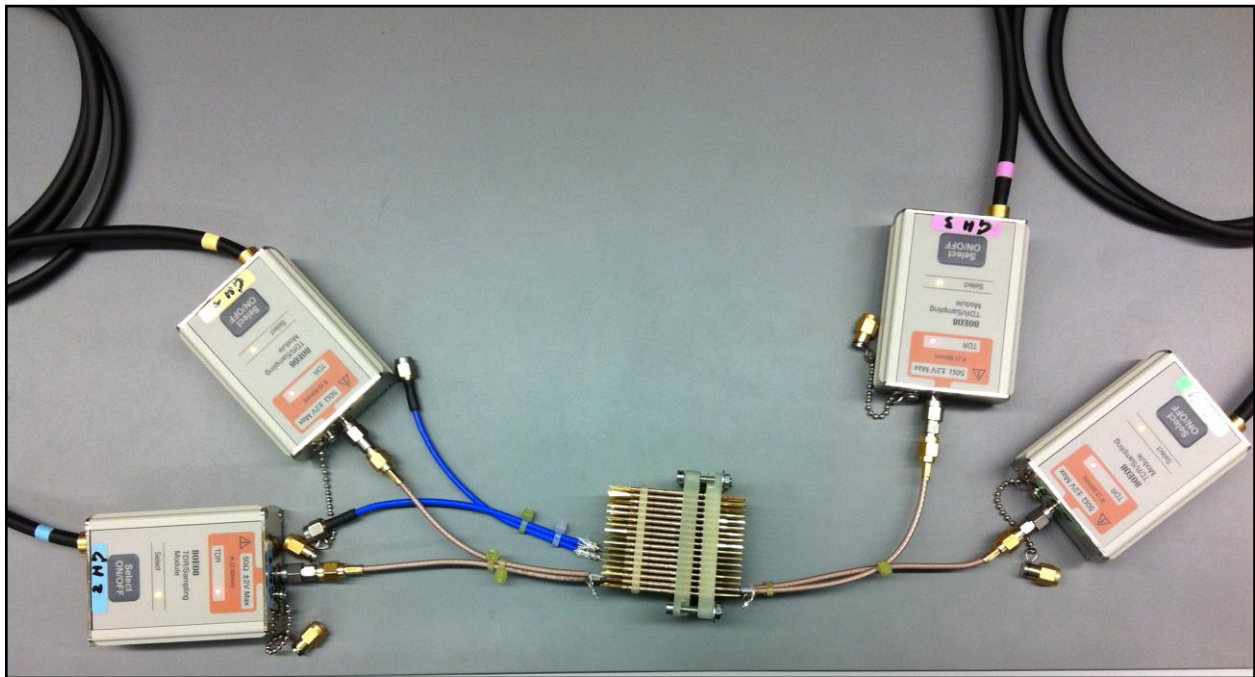

Figure 11 - Measurement setup with 4 x 30 GHz detector heads

A side-plane view is presented in *Figure 13*. The calculated impedance for most of the -air dielectric parts along the transmission line is 117.7Ω and is lower for the FR4-dielectric parts (because ϵ_r is in the denominator). Here we achieve approx. 58Ω . Now the question is: Can this solution be used for high-speed data transmission? After all, some parts greatly deviate from the required nominal impedance of 100Ω and if so, up to what data rate. The short answer to the first part of the question is “yes” because the inhomogeneous part is rather short and the overall impedance behavior (mean value) still is close to 100Ω (the 58Ω parts are quite short).

The maximum permissible data rate has to be evaluated with eye-diagram measurements. *Figure 12* gives a direct comparison between the computed impedance behavior (formulae) and the actual measurement. The impedance steps can be clearly seen. A sampling scope with 4 TDR detectors (30 GHz bandwidth) has been used to acquire the results. The resolution of the scope in this configuration has been set to 10 ps.

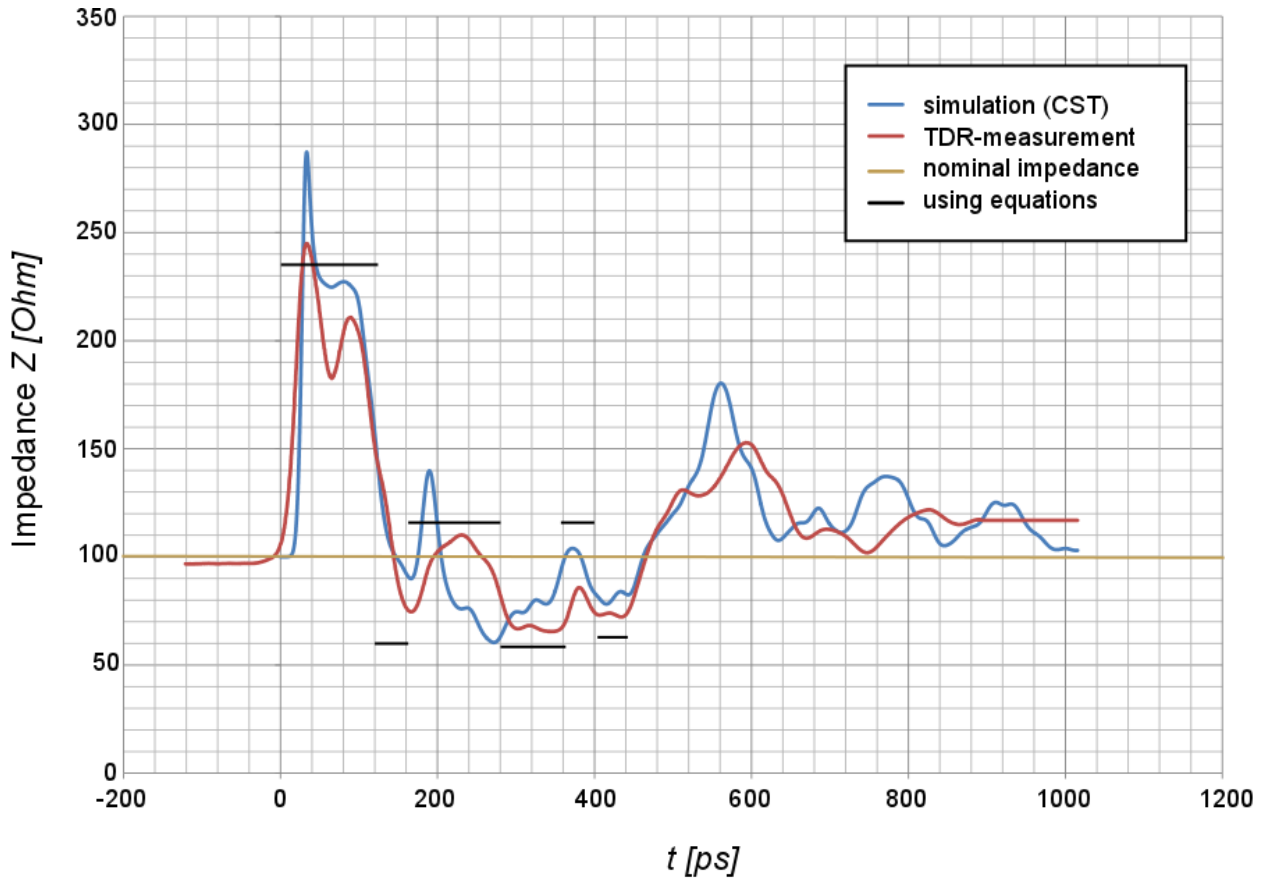

Figure 12 - Simulation vs. measurement comparison

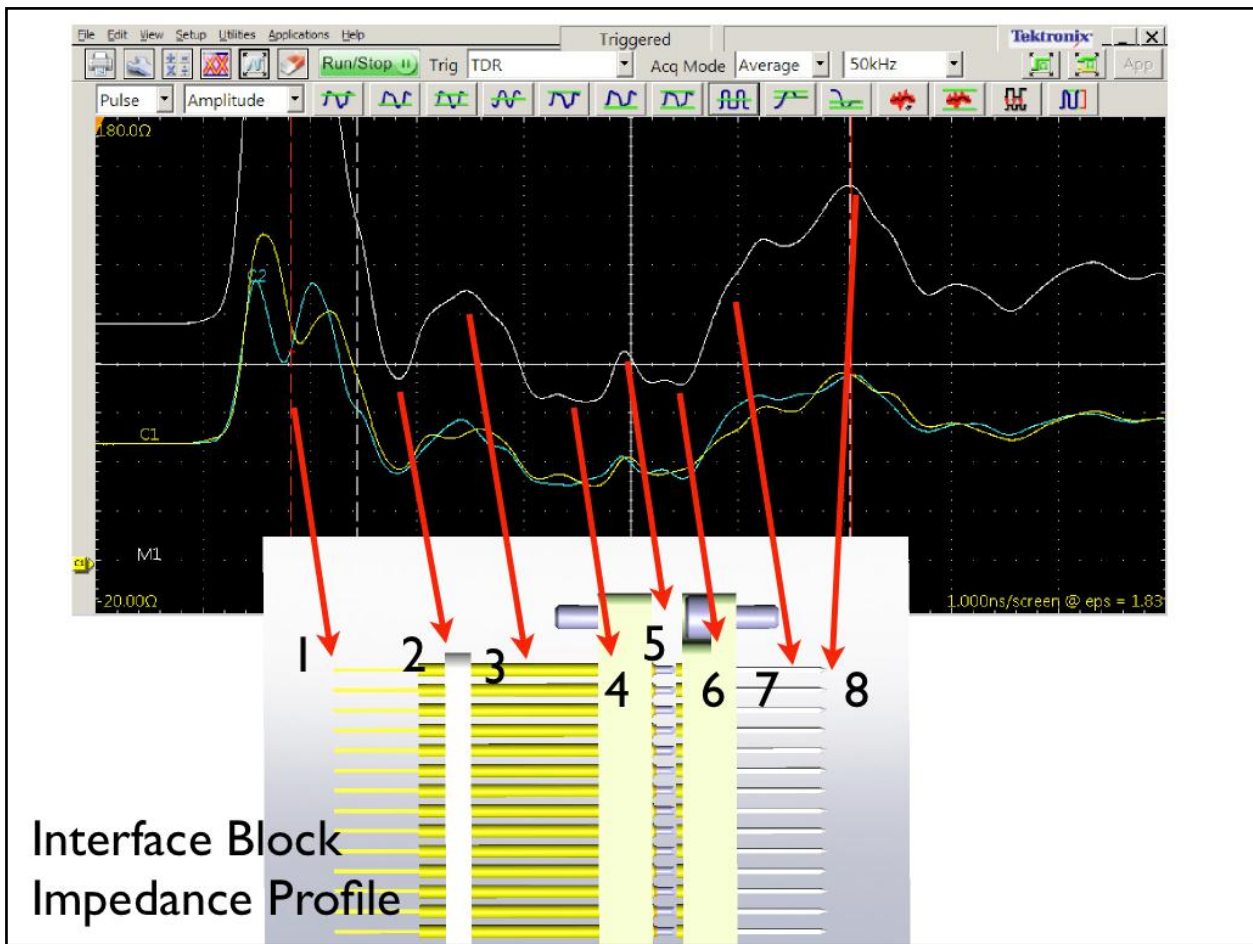

Figure 13 - Impedance profile for a 170 pin interface block

2.7 Presentation of a production-line, high-speed digital probe with integrated floating mechanism

In the previous chapters we discussed the importance of same lengths and proper soldering procedures etc. in order to maintain high signal integrity for production-line testing of high-speed data components. If the DUT is a data connector, a simple solution is not to probe on a PCB pattern next to the connector but right onto the connector.

A further inaccuracy factor (especially with mechanically large components or units e.g. in inline-test systems) is the position tolerance of the connectors. Not only does the connector itself have some mechanical tolerances, but also the position on the board can deviate significantly. Also the fixation mechanism in the test factor plays a vital role in regards to the overall positioning accuracy of the DUT. It is not uncommon to have components with inaccuracies of 0.2 or even more tenths of a millimeter vs. the nominal position.

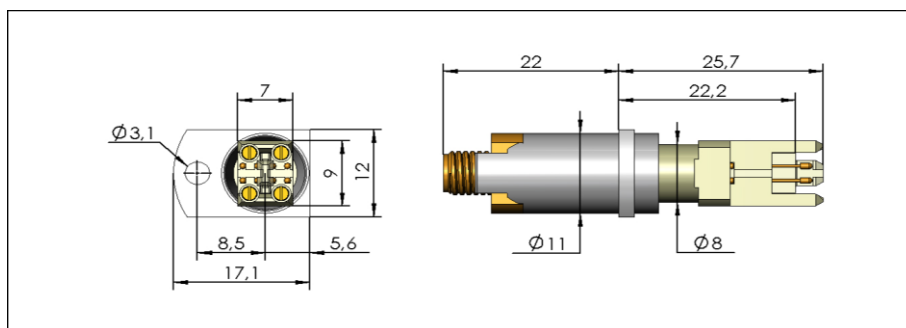

Figure 14 - High Speed Digital probe for a data connector

With PCB land-pattern probing this can lead to huge problems if no guiding mechanisms are installed. Probing on connectors is somewhat easier because several floating solutions with a self-guiding feature exist on the market. The idea is to integrate a spring around the outer shell of a test probe which in conjunction with a conically formed flange plate allows free centering in all directions (*Figure 14, 15 and 16*). This allows a secure mating with the counterpart even under extreme conditions. A chamfered edge at the front part of the probe allows a further alignment. Further introductory notes on this topic can be found in [MZ10] and [ZZ09].

probe in fully mated condition;
spring loaded center conductors slide over
the planar conductors of the DUT ("gentle" contacting, yet at the
same time secure fixation with excellent repeatability
and probe longevity)

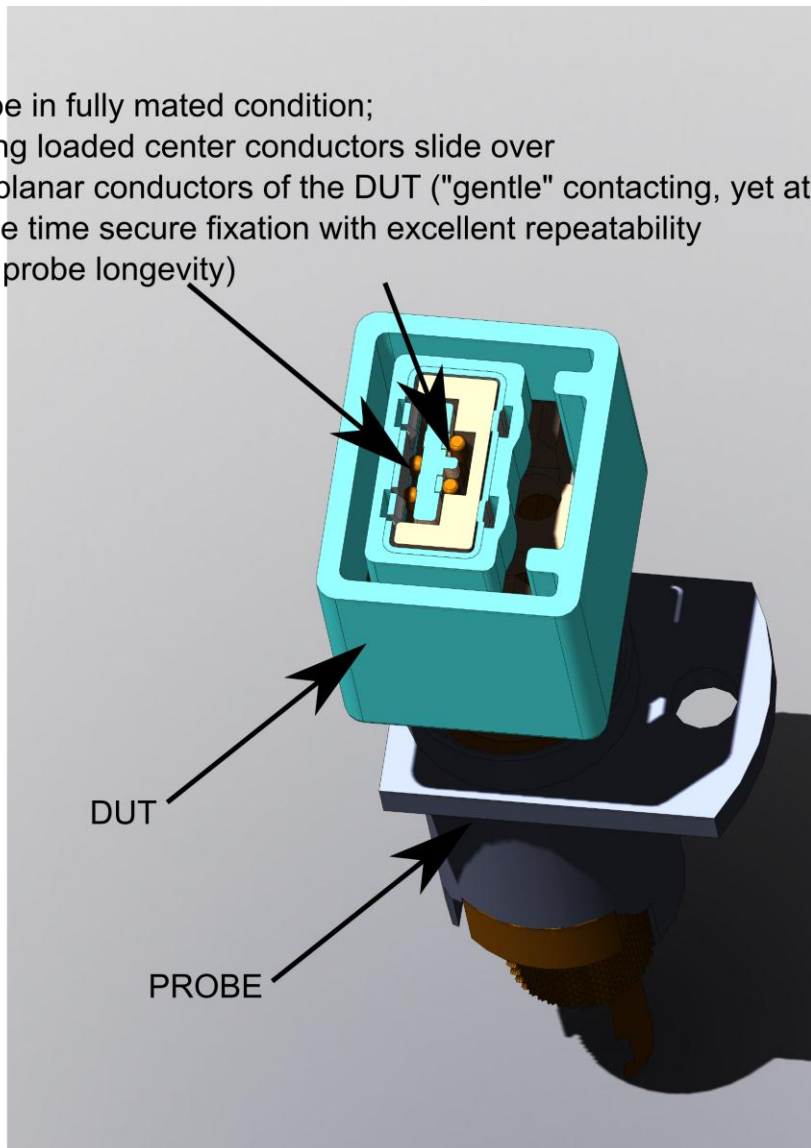

Figure 15 - Probe in fully-mated condition

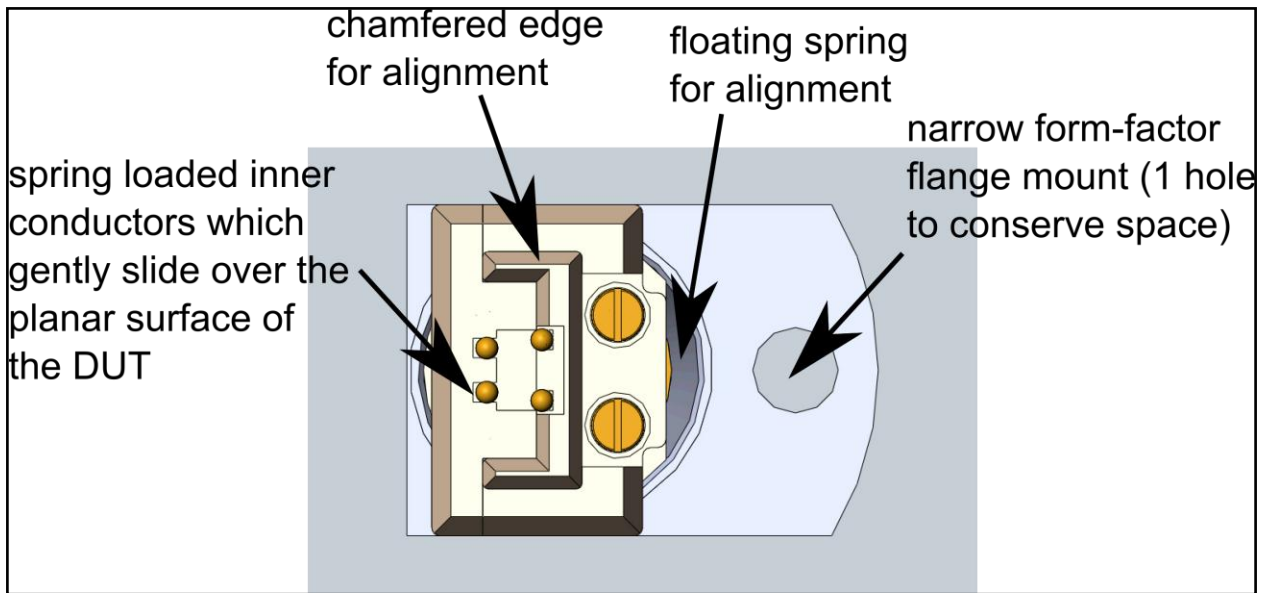

Figure 16 - Probe alignment features

3 Sequential probing using pneumatic probes

Pneumatic test probes are activated with compressed-air instead of a linear carrier-plate movement. The concept of air-actuated test probes is rather new and only a handful of manufacturers worldwide have adopted this concept until now - however the idea has become increasingly popular and thus deserves a dedicated chapter in this paper. Pneumatic probes have several advantages in comparison to conventional probing techniques in test fixtures:

- test points can be addressed individually (with standard spring probes, all installed probes contact the test board at the same time)
- also, contacting in groups is possible which simplifies sequential testing of various stages of an application
- test points that are hard to access are much easier to deal with when using pneumatic probes
- if components in explosive areas have to be rotated or moved, a pneumatic probe is the preferred and safe choice, because no electro-motor units are needed
- later enhancement of test points and layout changes are possible

Should the number of contacting points be low then a pneumatic probe even eliminates the need for a sophisticated test fixture.

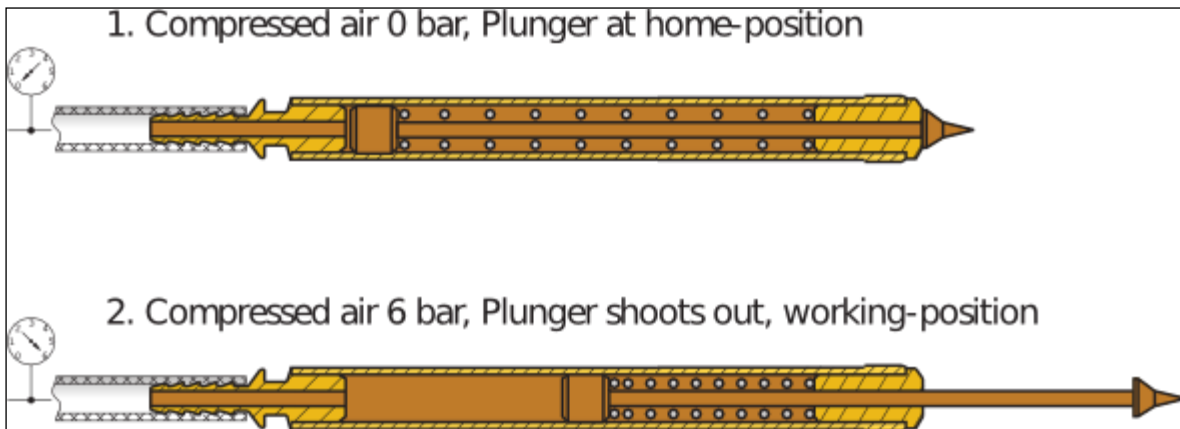

Figure 17 - Working principle of a pneumatic test probe [ING10]

Now let's have a closer look at the basic theory behind a pneumatic probe. The plunger movement inside the barrel works the opposite way to a regular spring-loaded test probe (see *Figure 17*). A regular probe needs to be compressed in order to make contact with the DUT. A pneumatic probe has a moving plunger that moves out of the barrel to make contact with the DUT. In order to do so, compressed air at the tail end of the probe is applied to the barrel. Contrary to conventional probes, the signal conductor wire is not soldered or wire-wrapped at the end of the probe. A small solder terminal (clip connection) is used to attach the wire. The force of a conventional spring probe gets higher as the stroke increases. For a pneumatic probe however, the force decreases with the movement of the plunger. At zero stroke (home position) the spring for example could have a preload of 1 N and at the recommended operating stroke 0.6 N. An additional advantage when contacting with pneumatic probes is the fact that the acceleration of the activated plunger helps to ensure a good contact when hitting the DUT (*Figure 18*).

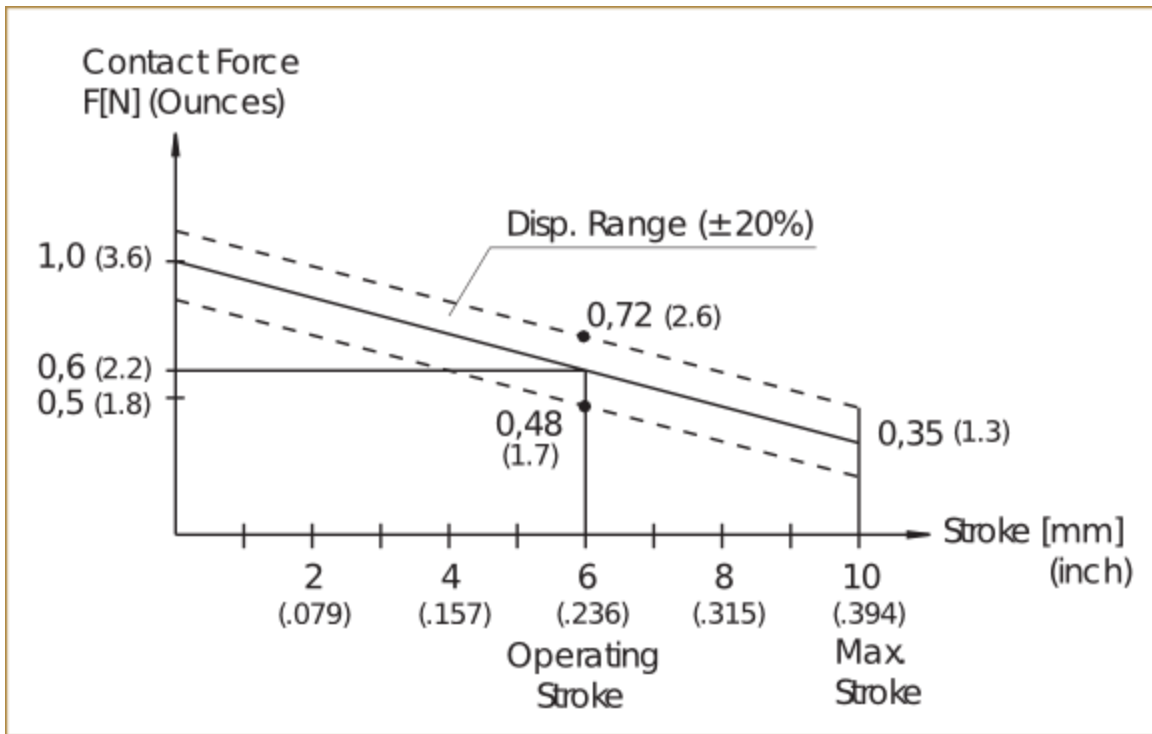

Figure 18 - Spring-force diagram (sample) for a pneumatic probe [ING10]

Sample schematic for group contacting of test points with pneumatic probes

The schematic in *Figure 19* shows 19 pneumatic test probes, paired in 4 groups with corresponding distributor units. A micro-valve unit is used to actuate each individual group. The valve unit can be driven with 12 VDC.

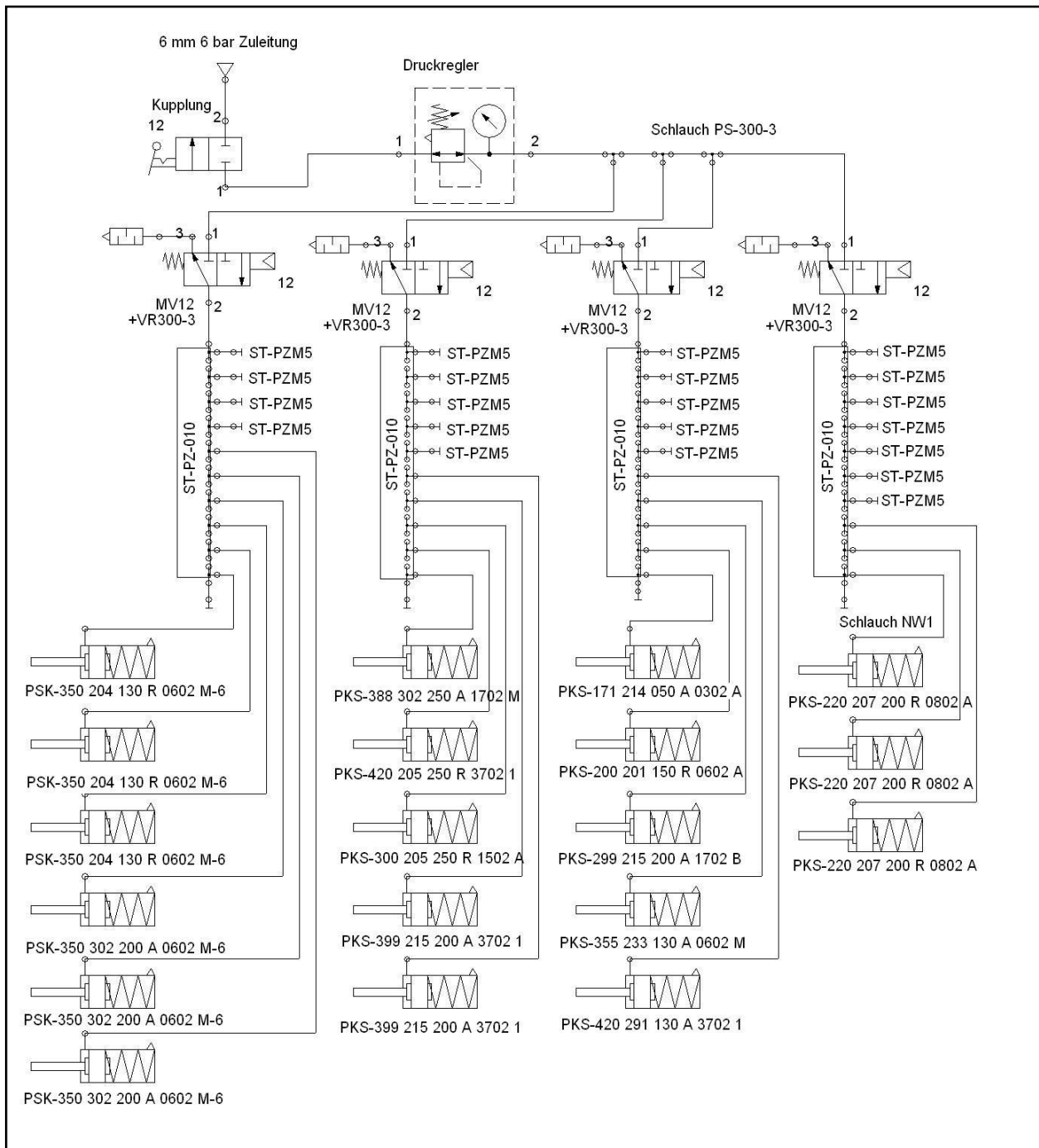

Figure 19 - Schematic for contacting 19 pneumatic probes in 4 groups

4 Conclusion

In *Chapter 1*, we have presented some ideas and theory to overcome overheating problems for high current applications. This is certainly not an easy task - at the same time working with high current can be quite dangerous. In the fast-paced product cycle environment of today the Test Engineers need some time to develop a high throughput, yet safe test procedure for the high current world. We hope to provide some room for thinking with our short introduction. In *Chapter 2* we took the same Pylon block for a totally different application, namely the transmission of high data rates. This is a special world of its own – but not as dangerous. However, the test strategy also needs some preparation time because with ever-increasing bandwidths and data rates, the components need to have stabilized impedance for proper signal integrity values. In the *last Chapter* we gave a short introduction into the field of air-actuated probing solutions and how these probes are different from conventional spring-loaded test probes and what benefits the Test Engineers have by using them.

Costs can be reduced because some functional fixtures can be extremely simplified by the implementation of pneumatic probes, sometimes a “full” fixture is not even needed at all. As a conclusion, the authors hope to have presented some valuable information and ideas for novel probing solutions and how to tackle design challenges for today’s demanding applications. All probe manufacturers worldwide have excellent Design Engineers; we encourage you to get in contact with them before laying out your test strategy in order to achieve maximum performance and to avoid frustration or even financial loss due to production-line downtime.

Appendix / Literature

- [HUB04] HUBER&SUHNER AG: *HF Verbinder Handbuch*. 2004
- [HUB07] HUBER&SUHNER AG: *HF Koaxialverbinder - Hauptkatalog*. Edition 2007 / 2008
- [ING10] INGUN: *Test Probes Catalog 2010/2011*. URL: <http://www.ingun.com>
- [ING11] INGUN: *RF Probes Catalog 2011/2012*. URL: <http://www.ingun.com>
- [MAN12] MANTARO: *Impedance Calculators*. URL: http://www.mantaro.com/resources/impedance_calculator.htm. Search term: Discrete Structures, effective 01-10-2011.
- [MZ10] ZAPATKA, Matthias, Dipl.-Ing.(FH). Passive HF Prüfkomponenten für den Produktionstestbereich. In: *RadioTecC - Transmit & Test Solutions 2010*. GEROTRON COMMUNICATION GmbH, 2010.
- [ZZ09] ZAPATKA, Matthias, Dipl.-Ing.(FH). ; ZISER, Ralf, DIPL.-ING.(FH).: An Introduction to Coaxial RF Probing Solutions for Mass-Production Tests. In: *ARFTG Conference Digest-Fall 74th*. Broomfield, CO (USA), December 2009, p. 87 – 92



Novel Probing Concepts for Mass-Production Tests: Design and Challenges

INGUN / RNS International, Inc.

www.ingun.com

Matthias Zapatka, Dipl.-Ing.(FH), c +1.408.310.3012

matthias.zapatka@ingun.com

Cupertino, CA

Otmar Fischer, Dipl.-Ing.(FH), p +49.7531.8105.596

otmar.fischer@ingun.com

Konstanz, Germany

Sven Nocher, p +704.329.0444

sven.nocher@rns-usa.com

Charlotte, NC



Scope of this presentation...

PART 1: High Speed Digital Probing Applications

PART 2: High Current Applications:
Challenges for Multi Probe Setups

PART 3: Sequential Probing with
Pneumatic Contacting Solutions



I. High Speed Digital Probing Challenges

Background

- Exponential increase of entertainments systems / other consumer electronic devices →
- Test and qualification process more and more complex.
- 10 ys ago: Data rates = low. Now: in the Gbit/s range – with high bandwidths

PROBLEM:

- ❖ Mechanical length and other dimensions interfere with electrical properties (high frequency behavior)

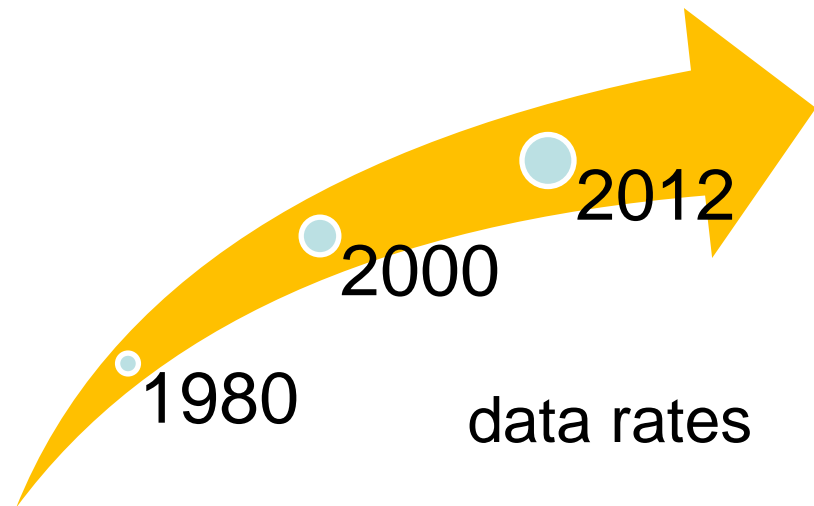



I. High Speed Digital Probing Challenges

Introduction: Phase Difference

$$vf = \frac{1}{\sqrt{\epsilon_r}}$$

$$vf = \frac{1}{\epsilon_r}; \lambda = \frac{c_0 \cdot vf}{f}$$

$$\lambda = \frac{c_0 \cdot .69}{240 \text{ MHz}} \approx .8626 \text{ m}$$

$$\Delta l = 5 \text{ mm}$$

$$\alpha = \frac{(\lambda - \Delta l) \cdot 360}{\lambda}$$

$$\Delta\alpha = \frac{(.8626 \text{ m} - 5 \cdot 10^{-3} \text{ m}) \cdot 360^\circ}{.8626 \text{ m}}$$

$$\Delta\alpha = 360^\circ - \alpha$$

$$\Delta\alpha \approx 2.09^\circ$$

- Given shall be the following config.:
 - 2 spring loaded probes
 - One string is 5 mm shorter
 - USB2.0 / 480 Mbit/s, $f_0 = 240$ MHz

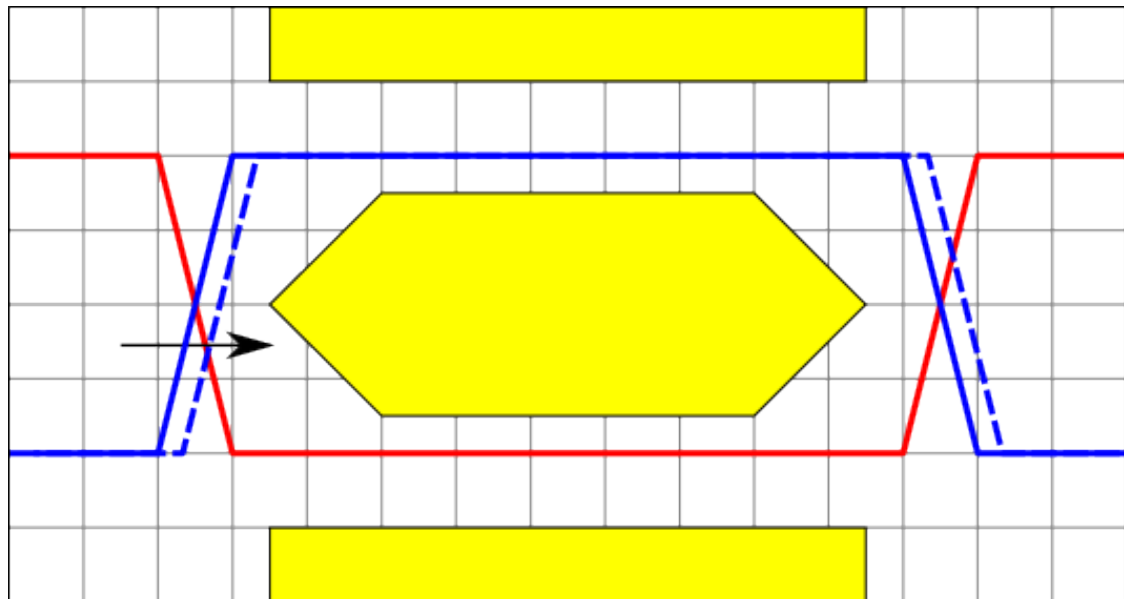



I. High Speed Digital Probing Challenges

Introduction: Differential Impedance

- Equation is used to derive the impedance between two conductors
- Ideally: 100 Ohm for most high speed digital application protocols
- Equation = inverse-hyperbolic-area function
- For $D/d > 2.5$ sqrt of the formula can usually be skipped with only minor inaccuracies
- Here: $D = 100$ mil, $d = 1.67$ mm, dielectric: FR4, $\epsilon_r = 4.1$, dispersion not regarded

$$Z_{\text{diff}} = \frac{120}{\sqrt{\epsilon_r}} \cdot \text{arcosh} \left(\frac{D}{d} \right)$$

$$Z_{\text{diff}} = \frac{120}{\sqrt{\epsilon_r}} \cdot \ln \left(\frac{D}{d} + \sqrt{\left(\frac{D}{d} \right)^2 - 1} \right)$$

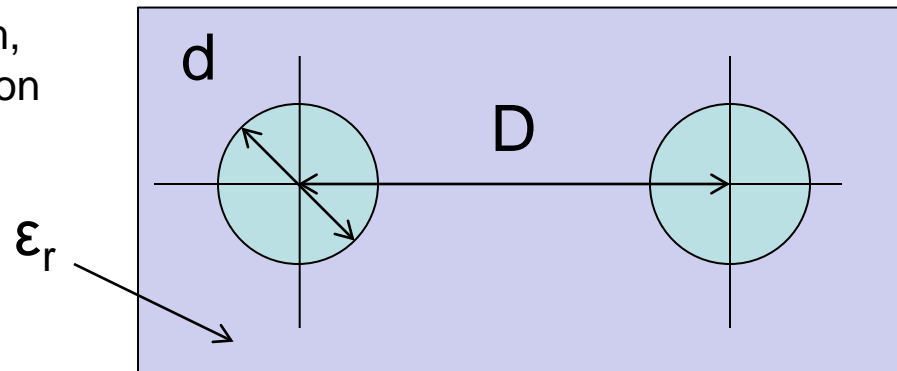



I. High Speed Digital Probing Challenges

Introduction: Differential Impedance

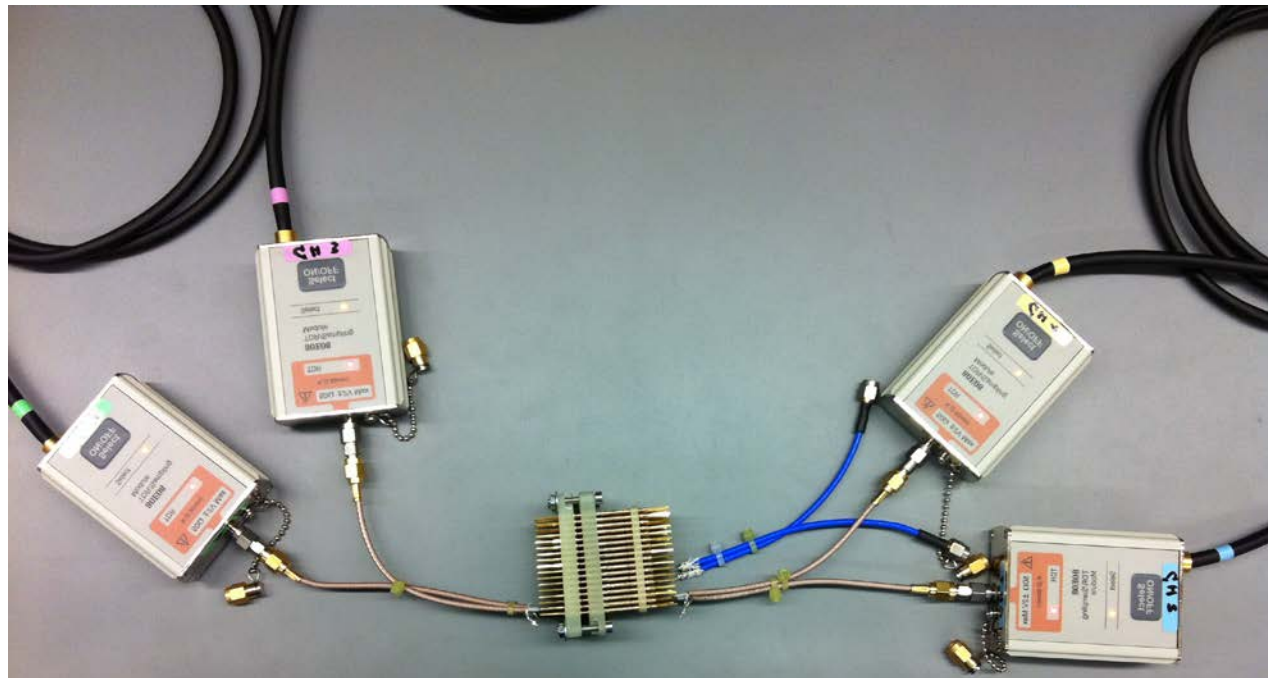
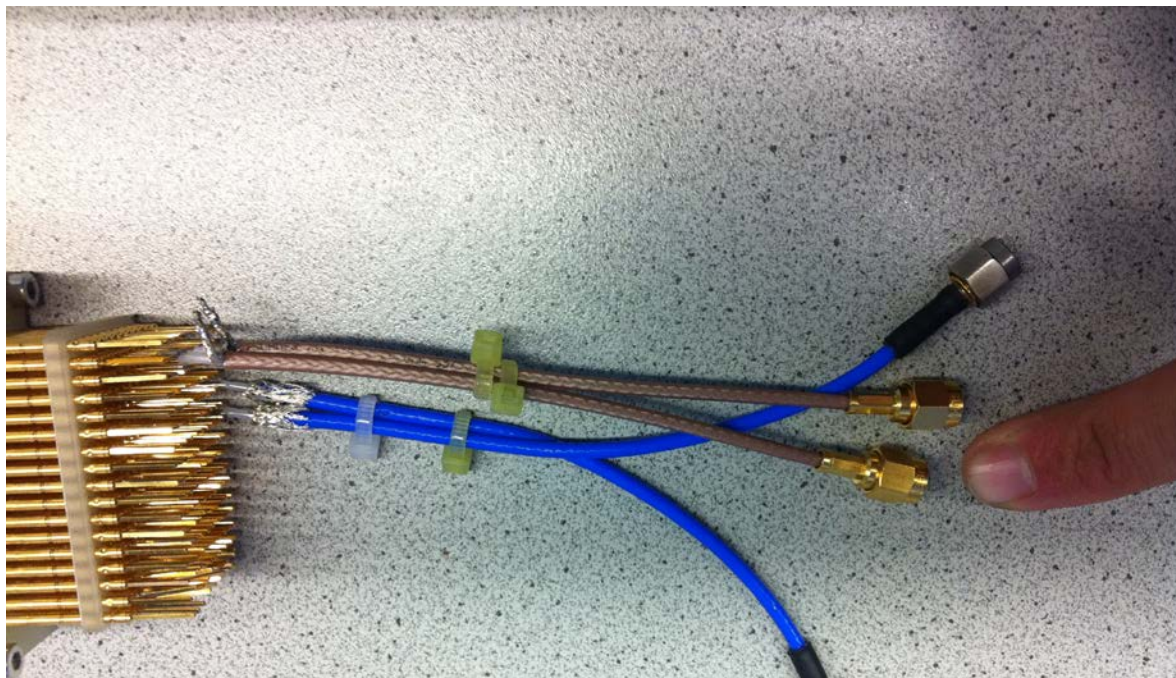

Figure shows the TDR detector heads (30 GHz) and the DUT (pylon block with 170 probes)



I. High Speed Digital Probing Challenges

Introduction: Differential Impedance



5mm length error (on purpose) to demonstrate the phase error in time domain



I. High Speed Digital Probing Challenges

Introduction: Differential Impedance

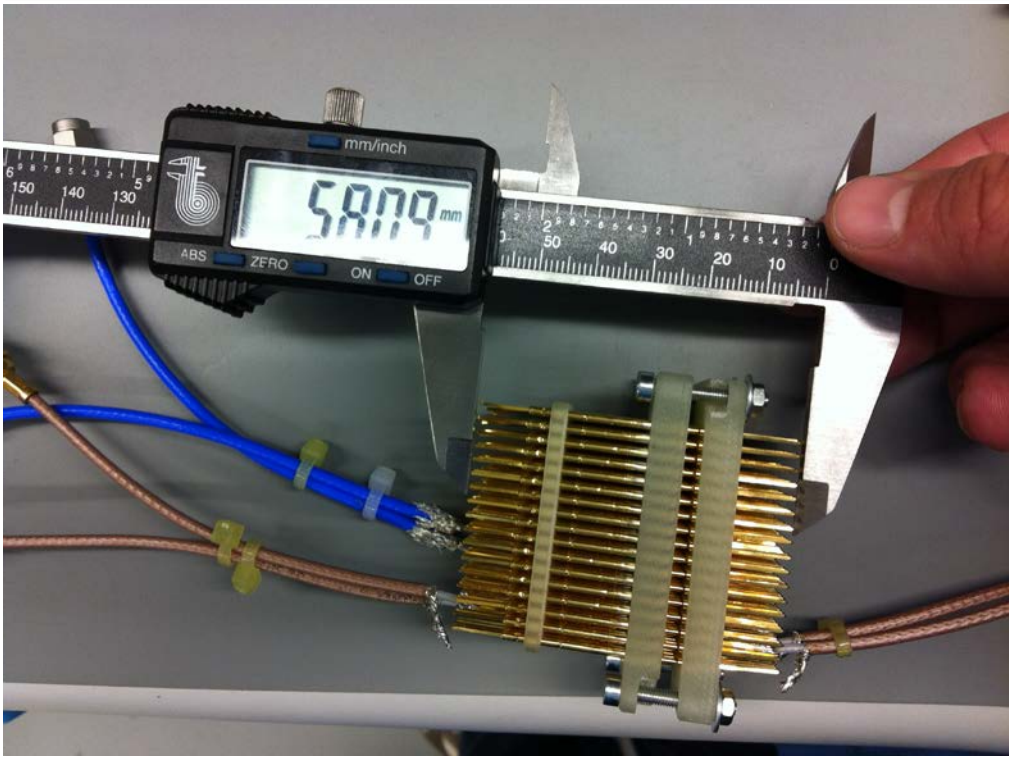

The dielectric value (ϵ_r) can be derived from a measurement of the mechanical length and comparison with the electrical length (using a TDR scope or VNA with IFFT mode)



I. High Speed Digital Probing Challenges

Introduction: Differential Impedance

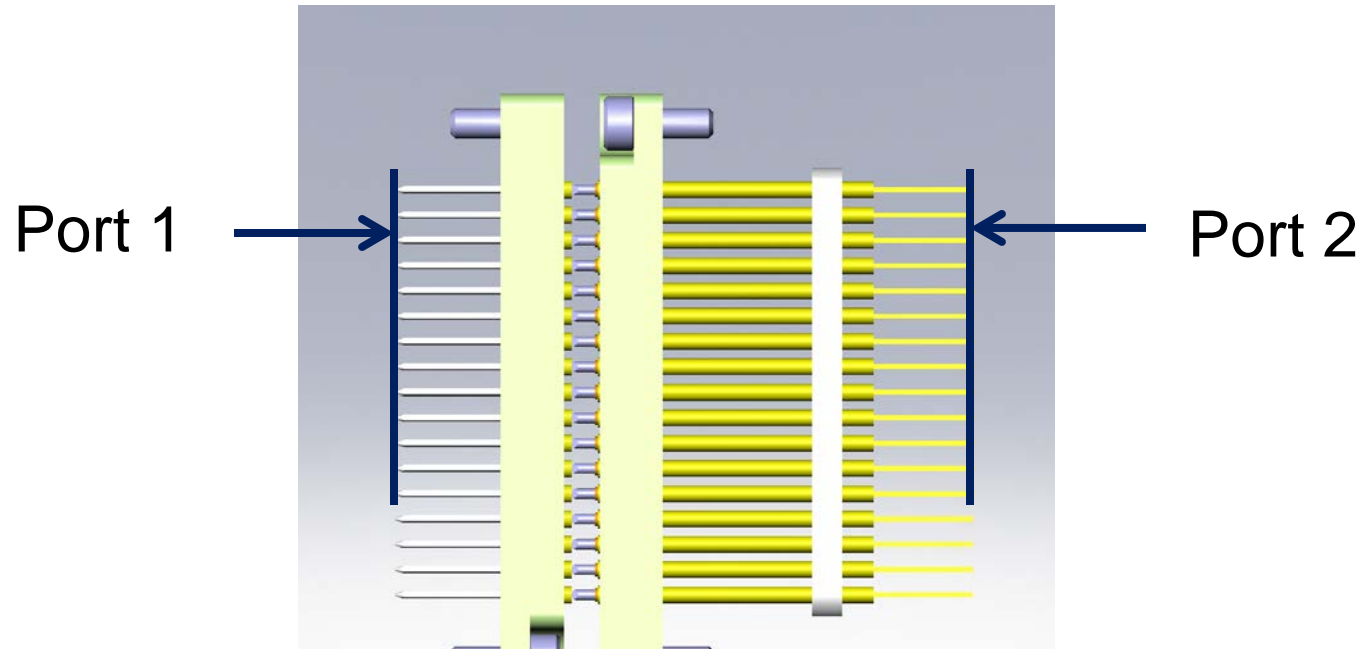

Cutplane view of the 170 pin block (in CST Microwave Studio)
To show the references planes which are used for the simulation and the measurement



I. High Speed Digital Probing Challenges

Measurement and Simulation Results

Impedance jumps due to change of the medium can clearly be located. The TDR scope shows the impedance along the line. Be careful to de-skew the two single-ended lines to align them to each other, otherwise the differential result will be of no use (next slide).

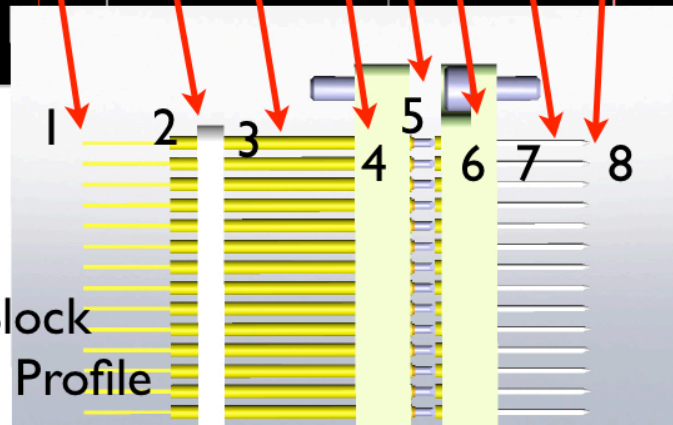

Interface Block
Impedance Profile



I. High Speed Digital Probing Challenges

Un-deskewed results: Length differences

Here: $\Delta d/2 =$ only 3.6 mm (!!!)

If you don't de-skew your results or better make sure that the lengths are the same for each string, **you end up in big trouble!**

The eye pattern will deteriorate due to a skew / phase difference!

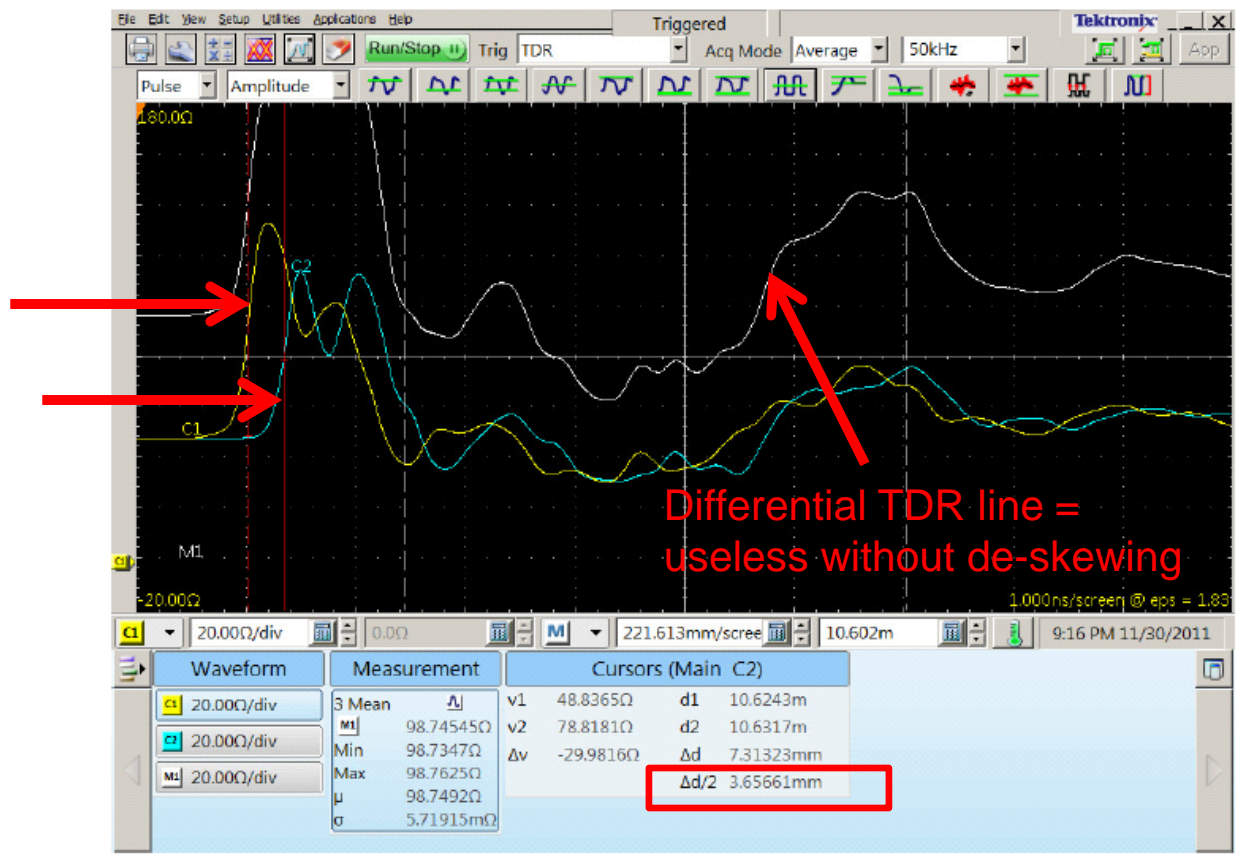



I. High Speed Digital Probing Challenges

What is the mixed ϵ_r of the block?

1. Set the boundaries (reference planes).
2. Make sure that the $\Delta d/2$ distance equals the mechanical length (use calipers or something precise to measure the mechanical length). Rulers and tape measures work for longer cable lengths for fault identification).
3. The mixed ϵ_r value will be displayed by the analyzer





I. High Speed Digital Probing Challenges

Measurement and Simulation Results

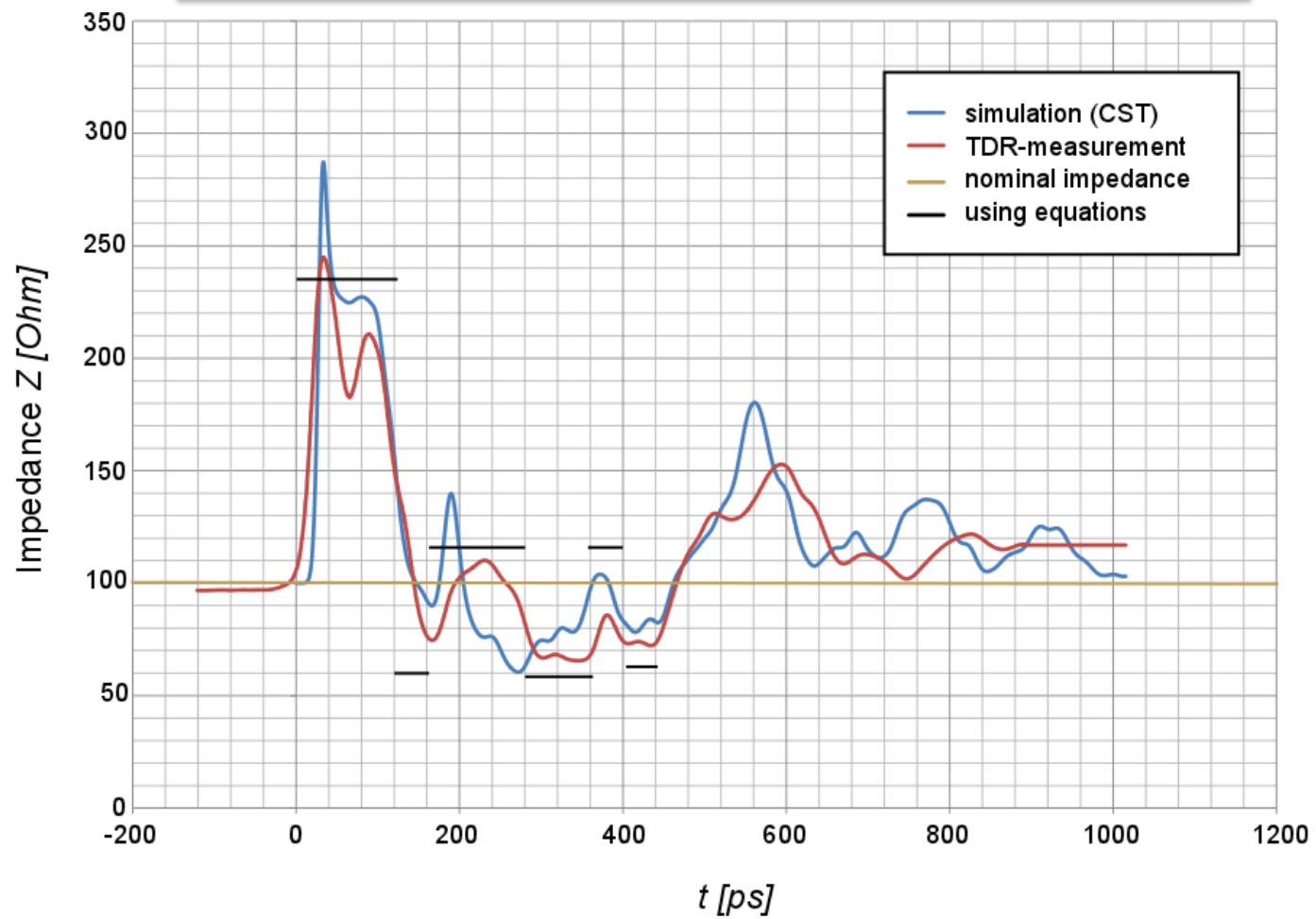



I. High Speed Digital Probing Challenges

Result interpretation...

Can this setup be used for the transmission of high speed digital signals with 100 Ohm impedance?

- *Yes, it can!* (Most certainly for USB2.0, for Gbit/s Ethernet etc. one would need to generate the eye pattern to see the behavior)
- Spikes can be reduced thru proper soldering and other connection techniques
- Cable lengths for the individual strings should be the same!!! If possible, try to measure the electrical length to be on the safe side and only allow some μs in Δt
- NOT all test-fixture houses / integrators are versed with proper RF / high speed digital installation procedures for passive devices thus...
- ...if you cannot perform these measurements on your own, ask an accredited test lab OR the probe manufacturer to provide you a quote for a TDR/ eye pattern measurement. All major manufacturers (should) have these capabilities, its worth spending a little bit more \$\$\$ than to have a test setup that fails the compliance test due to improper wiring and / or probe installation!



I. High Speed Digital Probing Challenges

High Speed Probes

spring loaded contacts,
high longevity

impedance-stabilized
transmission line
(inner parts not shown,
classified info)

proper launch terminal
for 100 Ohm twisted
pair cables

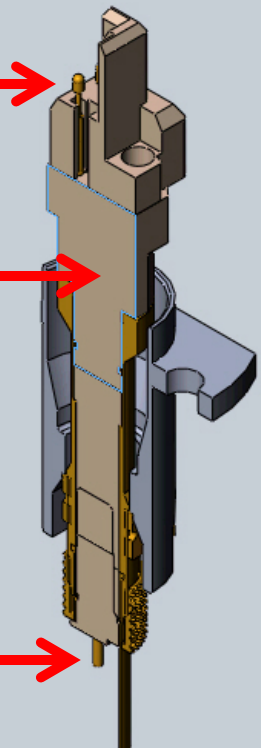

Finally, if you have proper cables, a well designed interface block, choose a proper probing solution as well! Regular, non-optimized spring probes could possibly degrade your test results. Thus make sure to use a dedicated high speed digital probe!

Such a solution is presented here and on the following slides.



I. High Speed Digital Probing Challenges

High Speed Probes

probe in fully mated condition;
spring loaded center conductors slide over
the planar conductors of the DUT ("gentle" contacting, yet at the
same time secure fixation with excellent repeatability
and probe longevity)

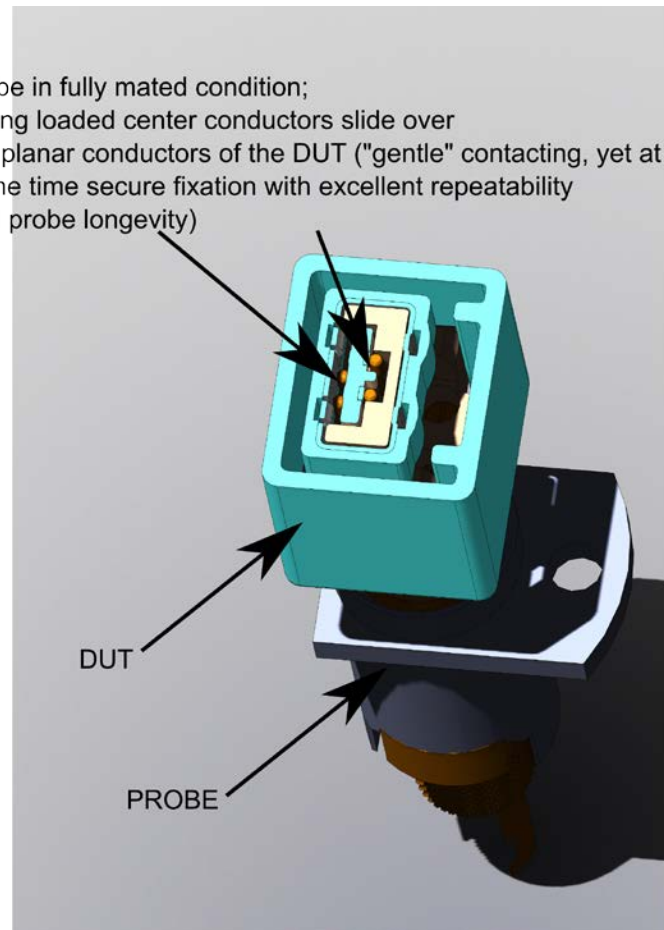

Motto: *Contacting instead of Connecting*

Conventional RF connectors:
Longevity not more than 500 –
100 mating cycles, see e.g.
[HUB07]

The 3D model shows the probe
and DUT in fully mated condition.
DUT = cutplane view to show the
spring loaded contact elements



I. High Speed Digital Probing Challenges

High Speed Probes

spring loaded inner conductors which gently slide over the planar surface of the DUT

chamfered edge for alignment

floating spring for alignment

narrow form-factor flange mount (1 hole to conserve space)

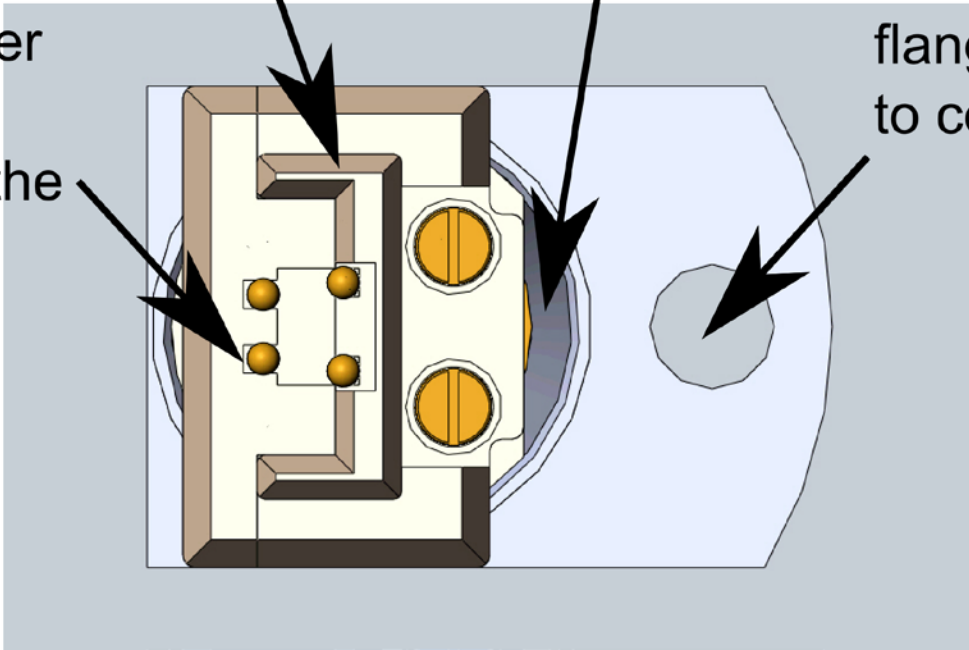



I. High Speed Digital Probing Challenges

High Speed Probes

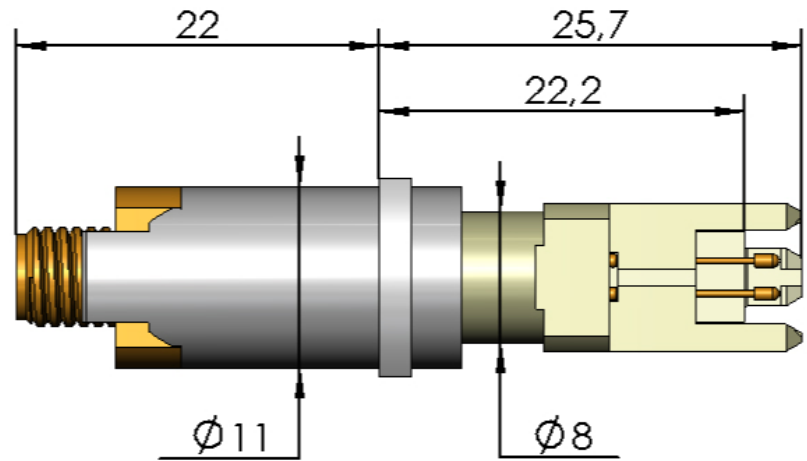
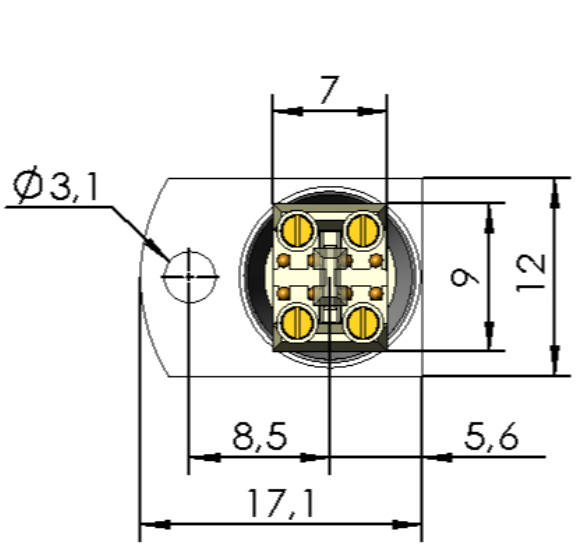



I. High Speed Digital Probing Challenges

Time for hands-on experience...



For this presentation, we have prepared a small test jig for the audience

1. A floating flange probe for a high speed digital connector (here: A common connector from the automotive market) plus DUT (jack) and OEM counterpart (plug)
2. The discussed 170 pin transfer block with attached cables
3. TDR measurement files

Compare the TDR slide with the mechanical dimensions of the transfer block. Mate both the high speed digital plug and the probe with the DUT (by hand) and check the differences.



II. High Current Probing

PART 1: High Speed Digital Probing Applications

PART 2: High Current Applications:
Challenges for Multi Probe Setups

PART 3: Sequential Probing with
Pneumatic Contacting Solutions



II. High Current Probing

Background / Heat Distribution

- Thermal evaluation of the probe properties → theory of thermal distribution among closely spaced test probes
- A 170 pin pylon transfer block is used to demonstrate the high current behavior
- Before we start with the measurements, some general ideas on how to increase the current rating of a test probe are presented on the right side and the next slide

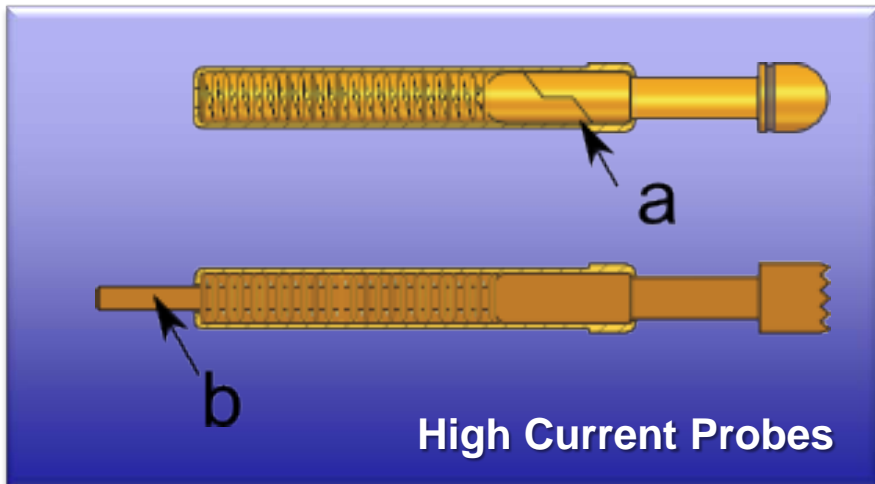
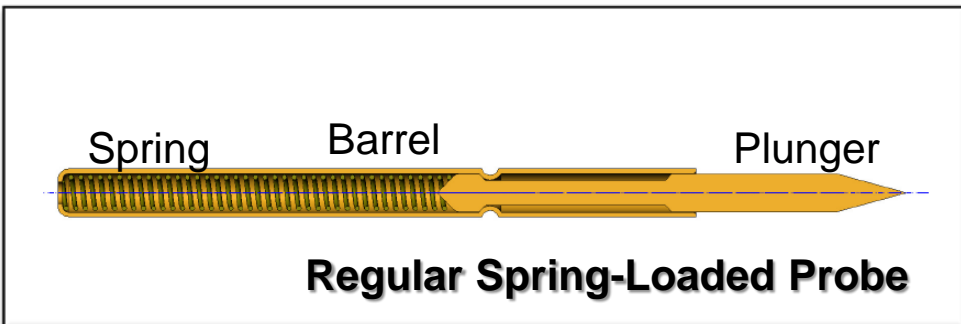



II. High Current Probing

Background / Heat Distribution

- Probe differences:
 - regular probe = barrel + plunger + spring
 - high current probe: consists of either continuous plunger or a blade to lower resistance and to increase the current rating. Also high current probes quite often have special platings

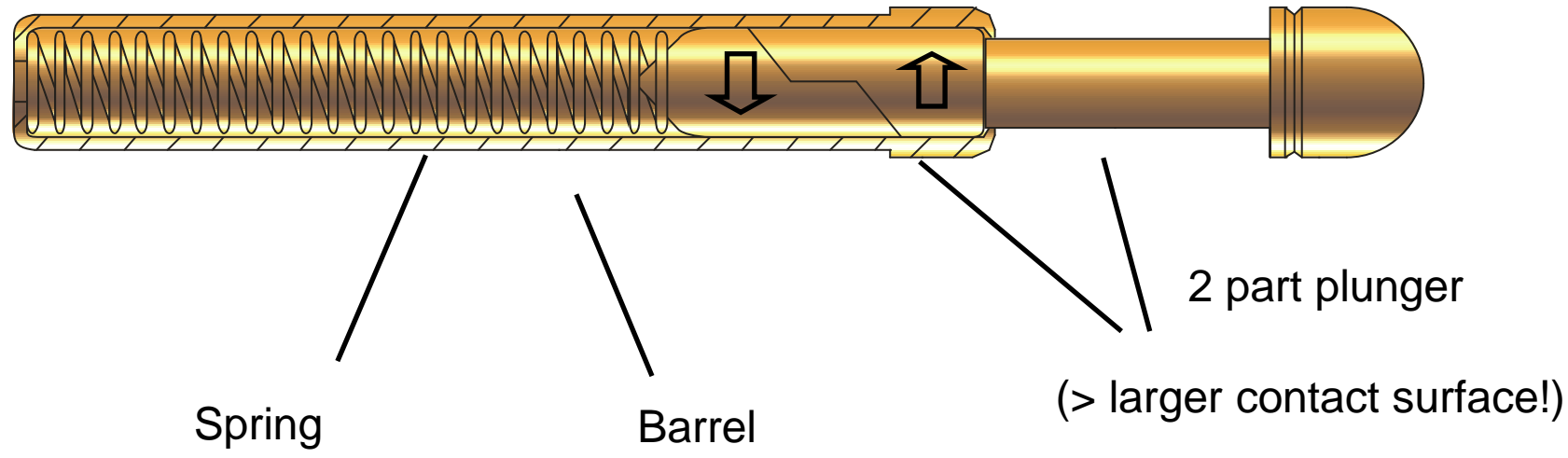



II. High Current Probing

Single-probe vs. multi-probe installations

- Situation becomes much more complex if several probes are installed next to each other AND are driven with more than a few *mA* at the same time.
- Rule of thumb: The farther the distance between the probe is, the better the current rating is (vs. the manufacturers nominal specified max. current)
- Thermal interaction if probes are spaced with a small pitch!

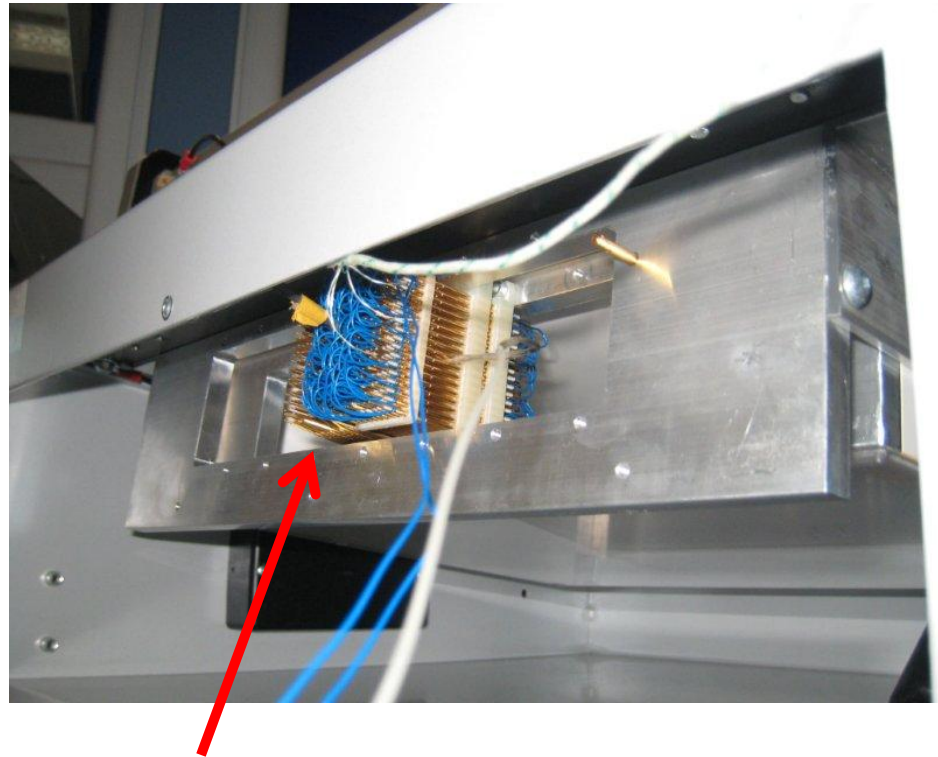

170 pin interface block with thermocouple element in a *real life* test Fixture (no test lab mockup)



II. High Current Probing

Single-probe vs. multi-probe installations

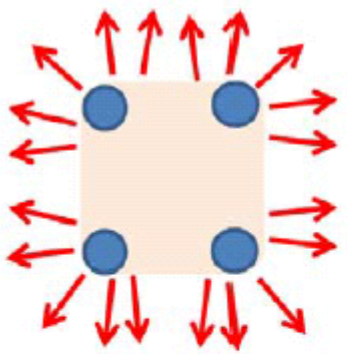
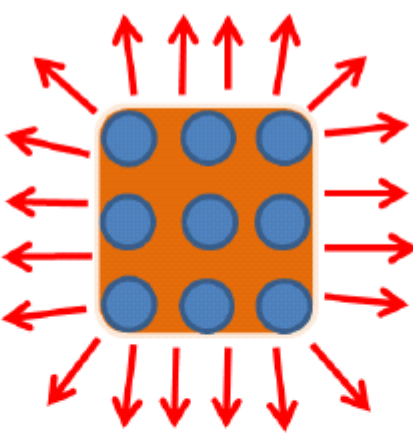
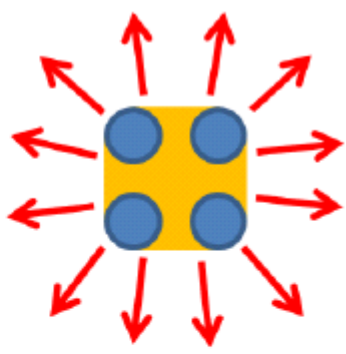
		
<p>Case (a): The distance between the probes is large enough. Heat can easily dissipate</p>	<p>Case (b): The distance between the probes is too small. Heat accumulates.</p>	<p>Case (c): Moderate heat accumulation, same pitch as in (b) but fewer probes. Better dissipation.</p>



II. High Current Probing

Simulation / Measurements

Test setup for the simulations and measurements:

- Interface block:
 - 170 pin interface block,
 - probe diameter 1.67 mm w/o receptacle
 - spacing 2.54 mm / 100 mil
 - outer dimensions of the block: Approx. 5 x 3 cm
 - dielectric material: FR4
 - Current rating 4A for 1 (!) probe
- Measurements: 170 x 1 A
- Simulation: 170 x 0-1 A, 5x5, 3x3 and 2x2 installations with larger pitch or same pitch and decreased size

Thermocouple element:

- placed at the most critical point (where the plunger tail touches the barrel)
- probes = standard 100 mil probes, (not a dedicated high current probe)

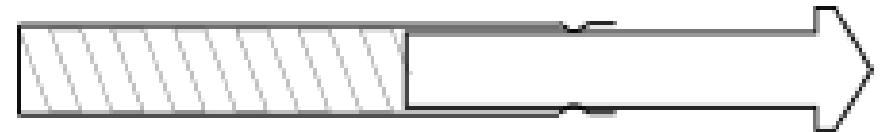

thermocouple sensor type K



II. High Current Probing

Simulation / Measurements

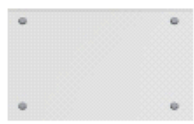
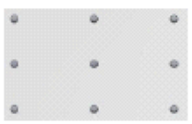
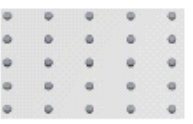
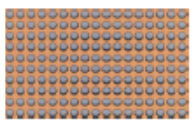

Case 1: Constant area

Table 2 – Multi-probe installation with constant area

			
2 x 2	3 x 3	5 x 5	10 x 17 (3 x 5 cm = outer dimension)

Case 2: Constant pitch between probes

Table 3 - Multiprobe installation with constant pitch

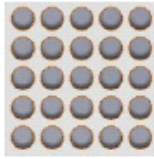
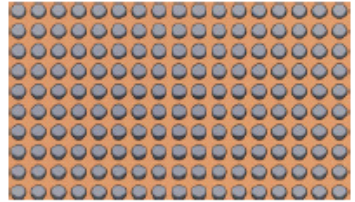
			
2 x 2	3 x 3	5 x 5	10 x 17 (3 x 5 cm = outer dimension)



II. High Current Probing

Simulation: Current over time

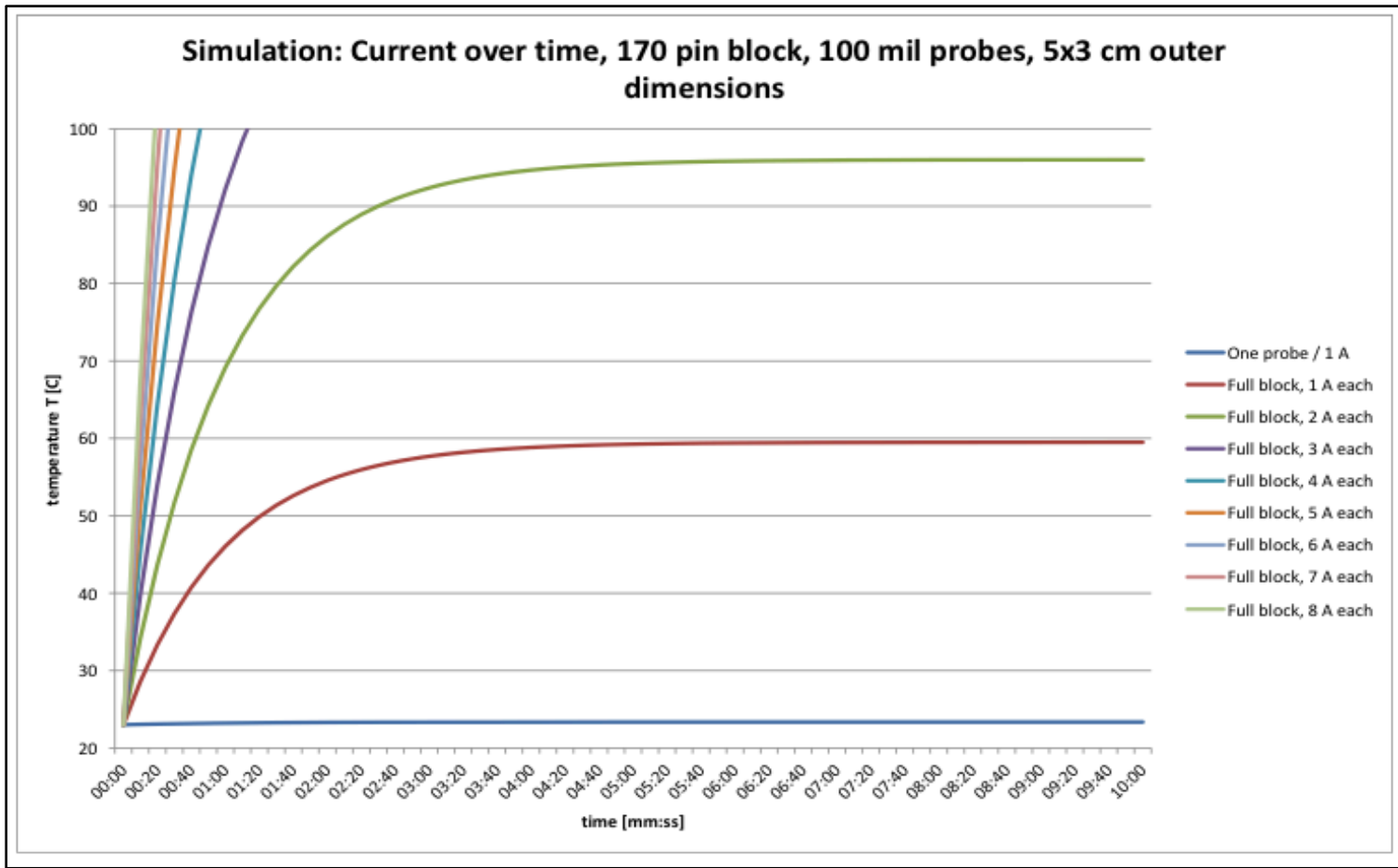



II. High Current Probing

Measurement: Current over time

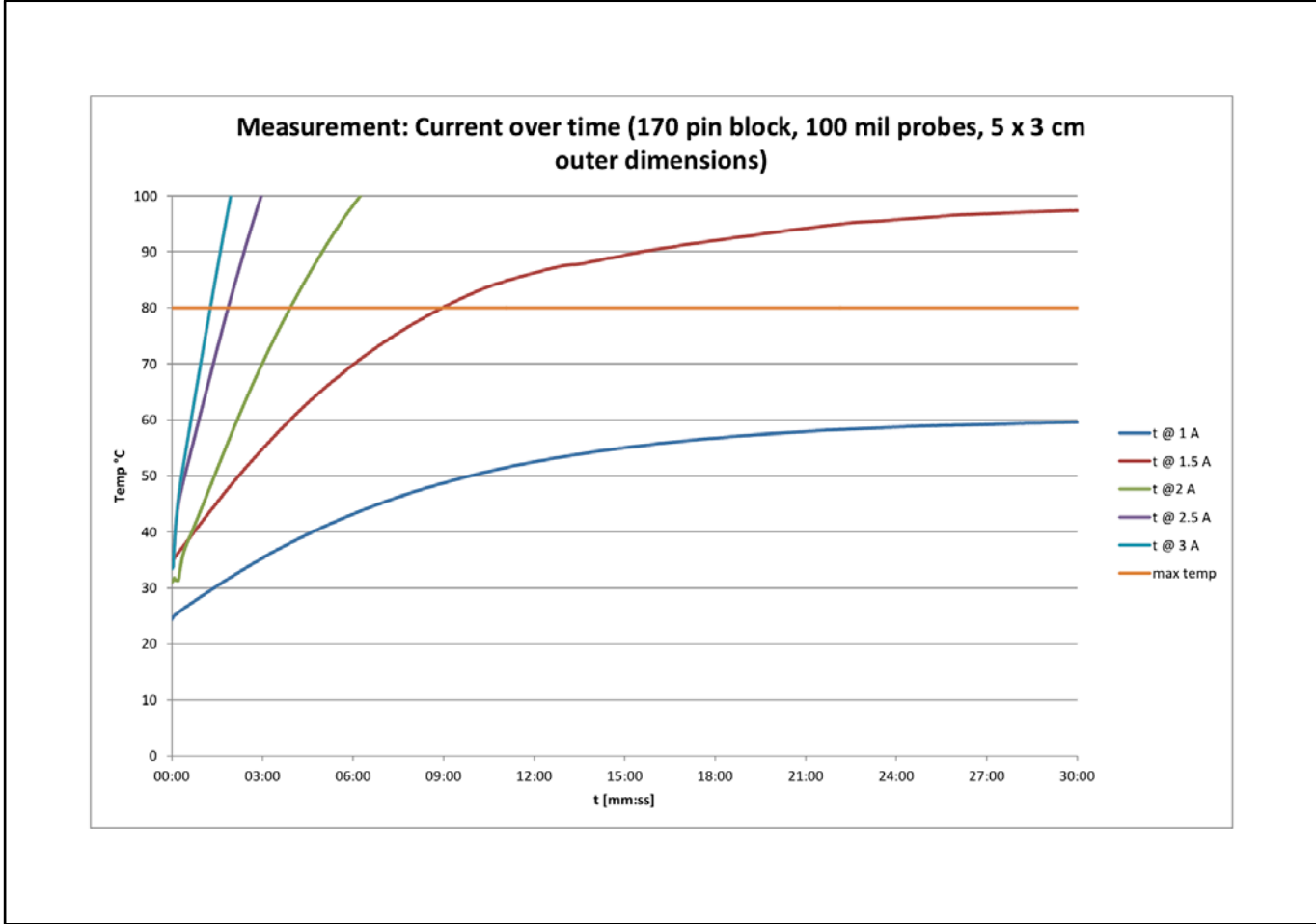



II. High Current Probing

Constant size

Measurement / previous slide:

- In this case we took probes that are usually rated up to 4 A. One might think that this applies to all kinds of configurations.
- But as one can see, even when only applying 1.5 A the critical temperature of 80C is reached after less than 9 minutes
- One might argue that most tests don't take that long, but...
- ...some tests have even higher current → after only about one minute, a block with the config *170 probes / current applied to all probes / 3 A* heats up to 80C
- **Consequence(s):**
 - usage of real high current probes vs. standard probes might be necessary
 - air flow is conducive
 - the whole test setup must be consequently thought-through – otherwise this could even lead to a safety hazard



II. High Current Probing

Constant size

Temperature curve for a constant area

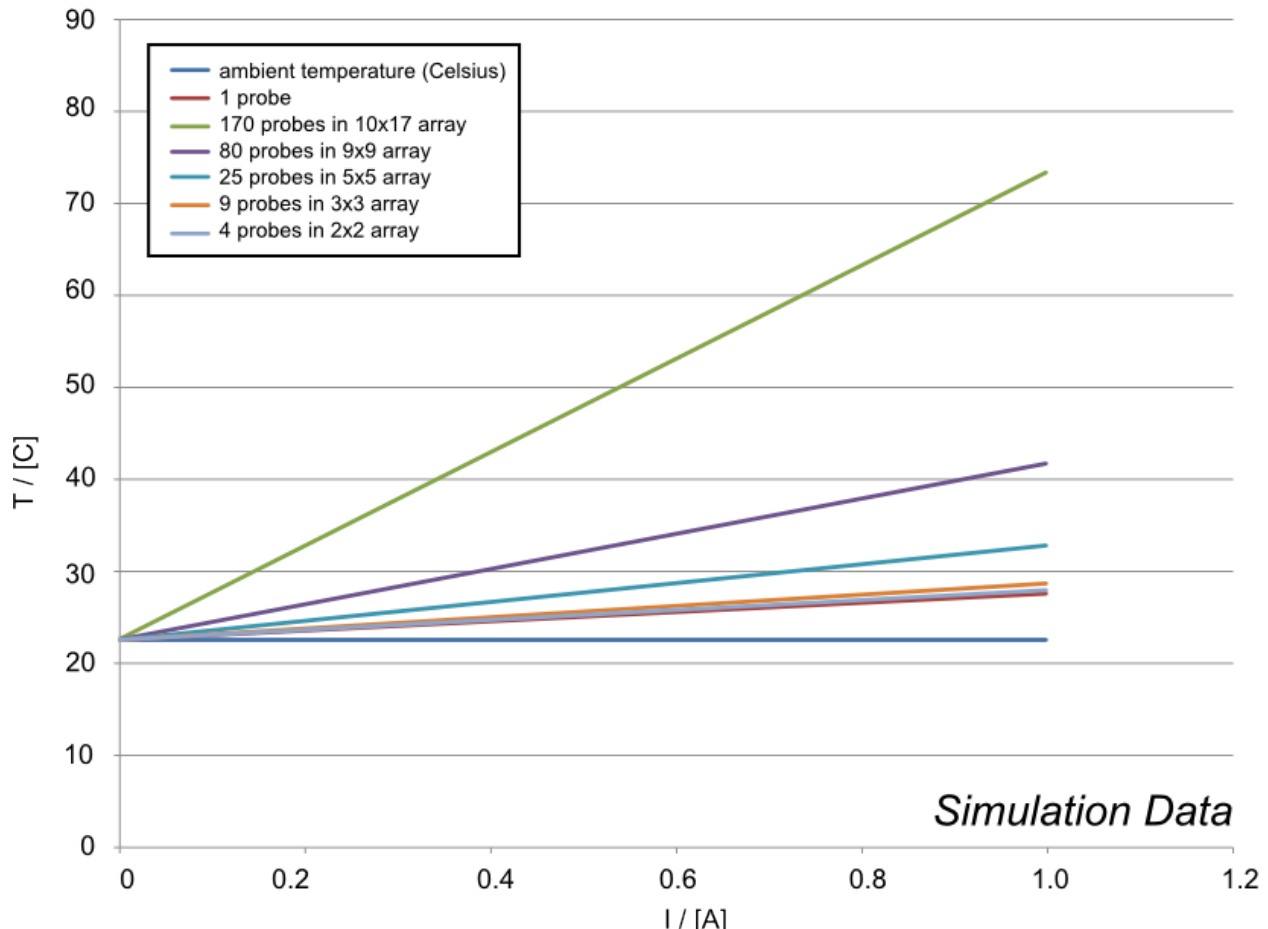

Simulation Data



II. High Current Probing

Constant size

Simulation / previous slide:

- Heat accumulation not significant for 1, 2x2 and 3x3 installations (5x3 cm outer dimensions) → heat starts to build up for 25 and more probes when being driven with more than 500 mA
- → if you have the space and enough slots for pylon interfaces, you might want to consider to spread the current over more blocks

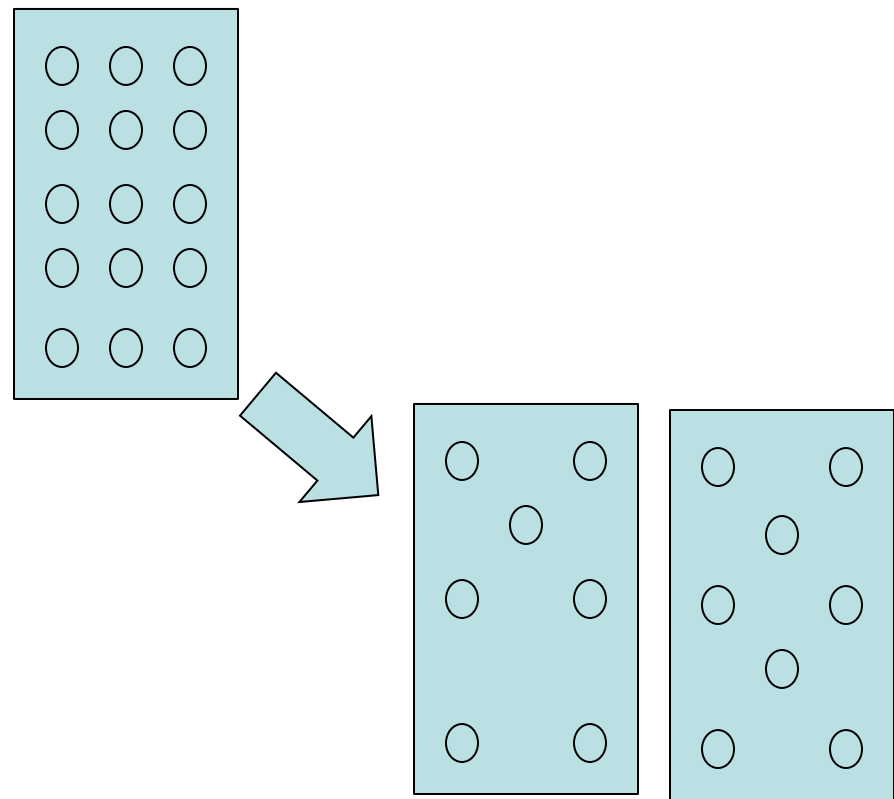



II. High Current Probing

Constant pitch (spacing between probes)

Temperature curve for constant pitch

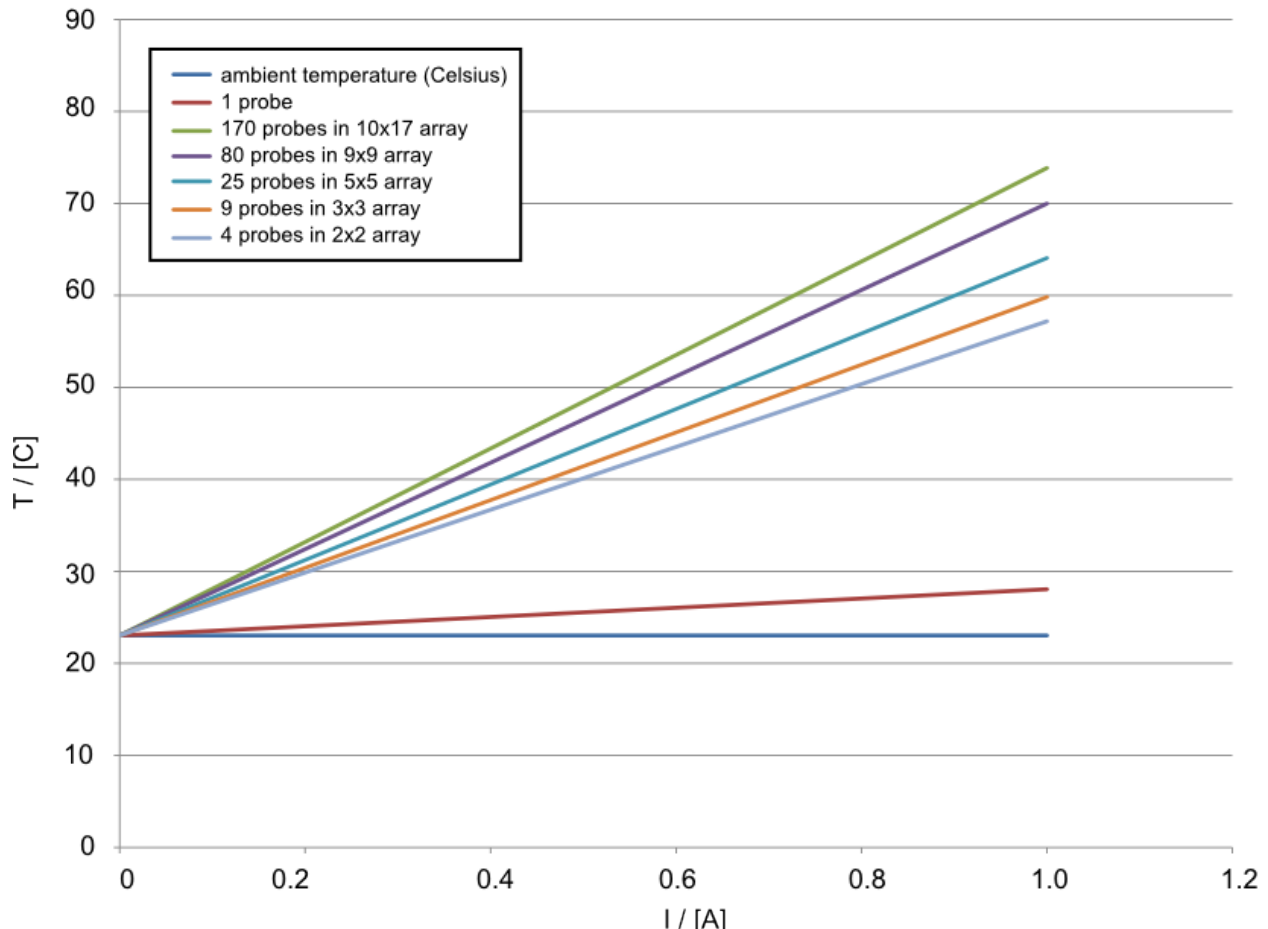



II. High Current Probing

Constant pitch

Simulation / previous slide:

- The situation gets much worse if you are bound to a certain pitch and have to drive multiple probes with more than 200 mA (!!!)
- In this case the only good choice to bring the heat down would be a forced convection (air vent(s), cooling fans etc.)
- Even 2x2 configs produce a large amount of heat for relatively low currents





III. Sequential probing with Pneumatic Probes

PART 1: High Speed Digital Probing Applications

PART 2: High Current Applications:
Challenges for Multi Probe Setups

PART 3: Sequential Probing with
Pneumatic Contacting Solutions



III. Sequential probing with Pneumatic Probes

Background

- Pneumatic probes are actuated with compressed-air instead of a linear carrier-plate movement
- Idea has become increasingly popular in the last few years

Advantages:

- ❖ test points can be addressed individually
- ❖ contacting in groups is possible
- ❖ test points that are hard to access are much easier to deal with when using pneumatic probes
- ❖ safe probing solution for explosive areas e.g. to actuate motor switches
- ❖ fixtureless installations possible
- ❖ later enhancement and changes of existing fixture designs are possible

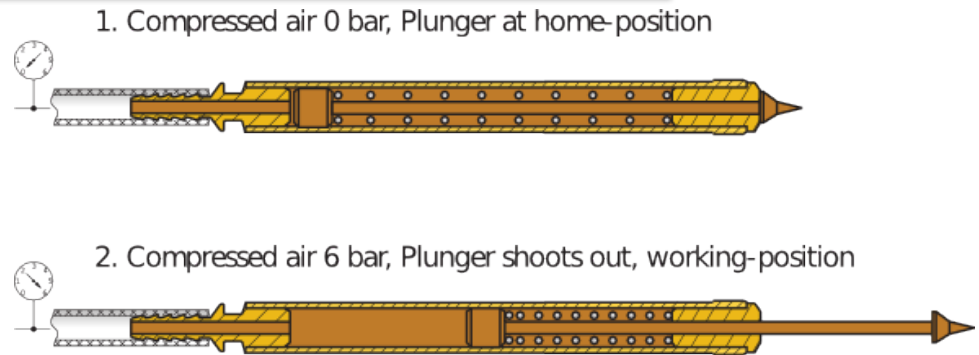



III. Sequential probing with Pneumatic Probes

Spring-force diagram vs. plunger travel (*sample*)

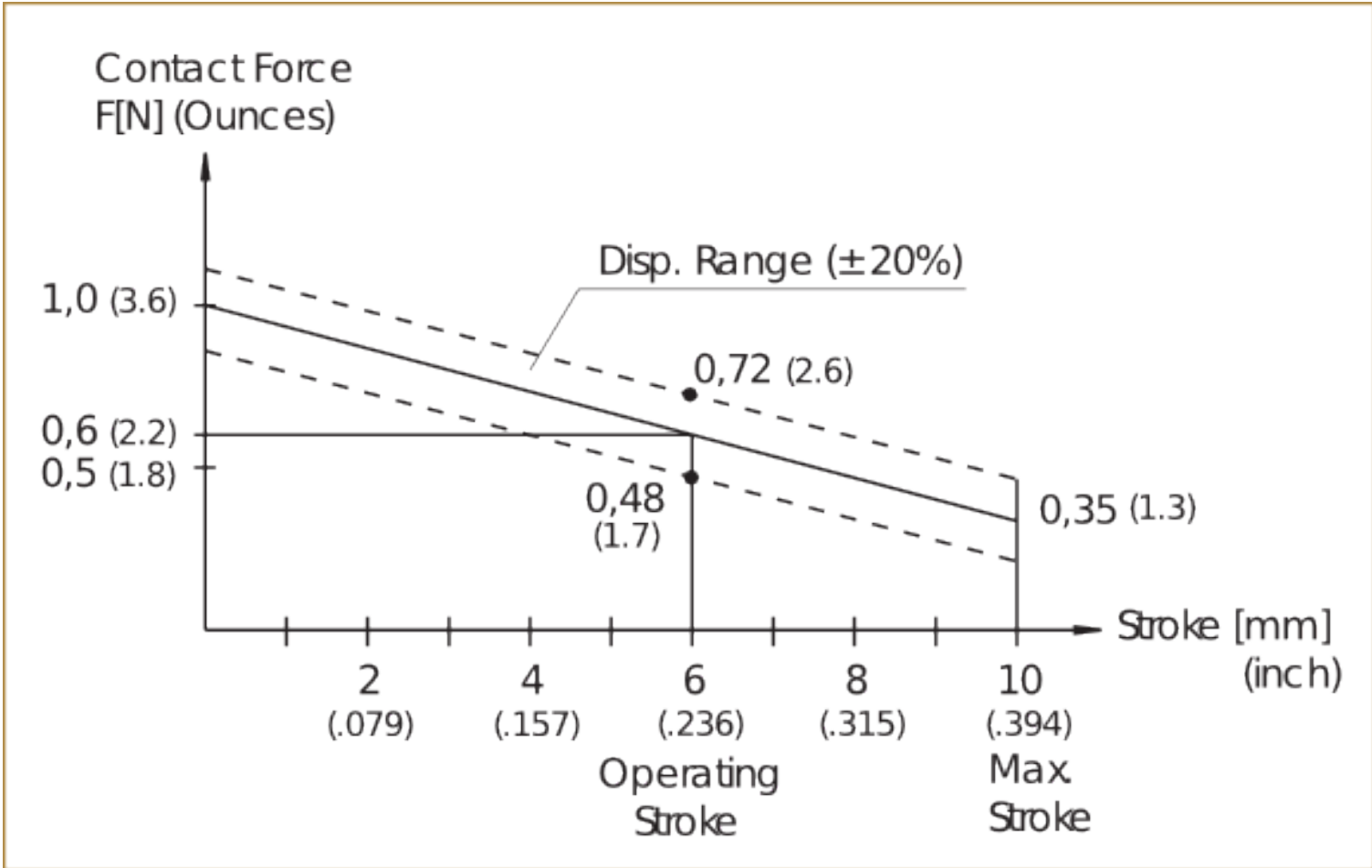



III. Sequential probing with Pneumatic Probes

Group contacting (sample schematic)

- schematic shown for contacting 19 pneumatic probes in 4 groups
 - micro-valve unit is used to actuate each individual group
 - valve unit can be driven with 12 V_{DC}
 - distributor blocks connect the probes to the valve
 - simplifies lateral test point approaches (side contacting)
- easy, fast, fixtureless

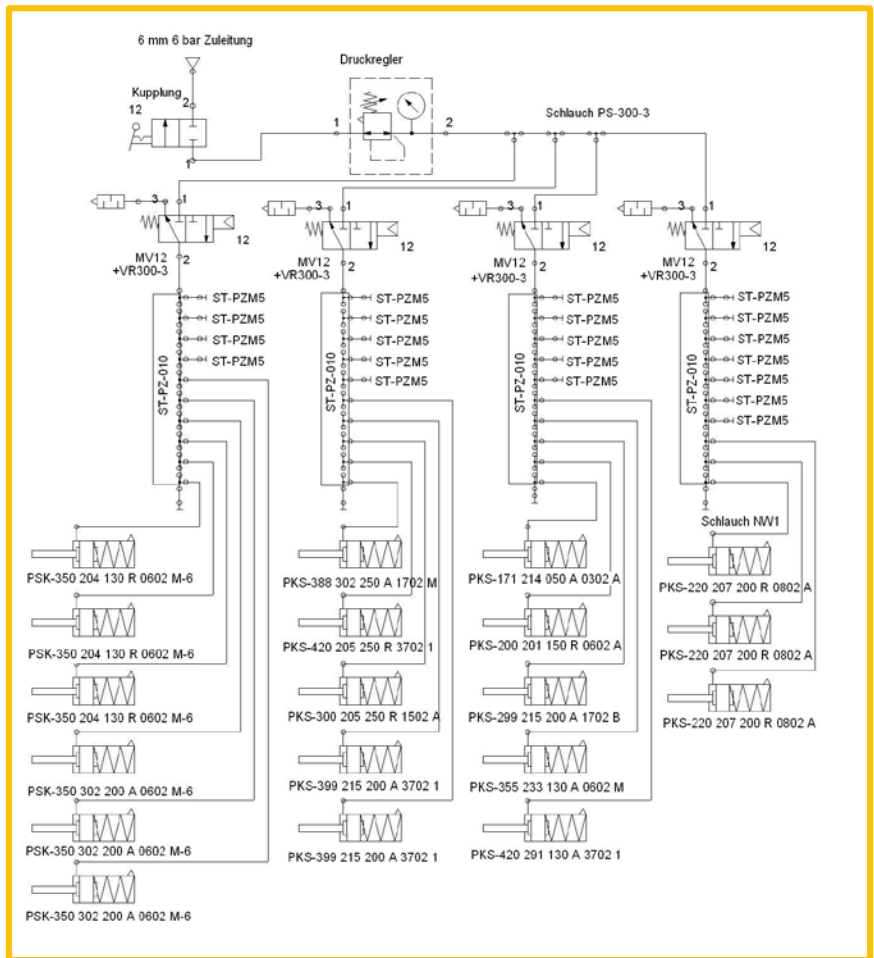



III. Sequential probing with Pneumatic Probes

Further probing apps for pneumatic probes

Solder flux residue and contaminated test points

- Principle: plunger shoots out → can be used to break thru oxide layers, solder flux residue etc.
- A word of warning though: the impulse force when breaking through the layer can be quite high, even board damages have been reported by some users → proper tip styles need to be chosen, and maybe a ramp approach 3 bar – 4 bar – 6 bar in steps

Other probing concepts for contaminated test points

1. probe with higher preload than a regular spring probe (force at working stroke would be the same)
2. probe with higher spring force, bears the same risks
3. probes with rotating plungers
4. probes with highly aggressive tip styles

Or a combination of 1. – 5.



III. Sequential probing with Pneumatic Probes

Time for hands-on experience...

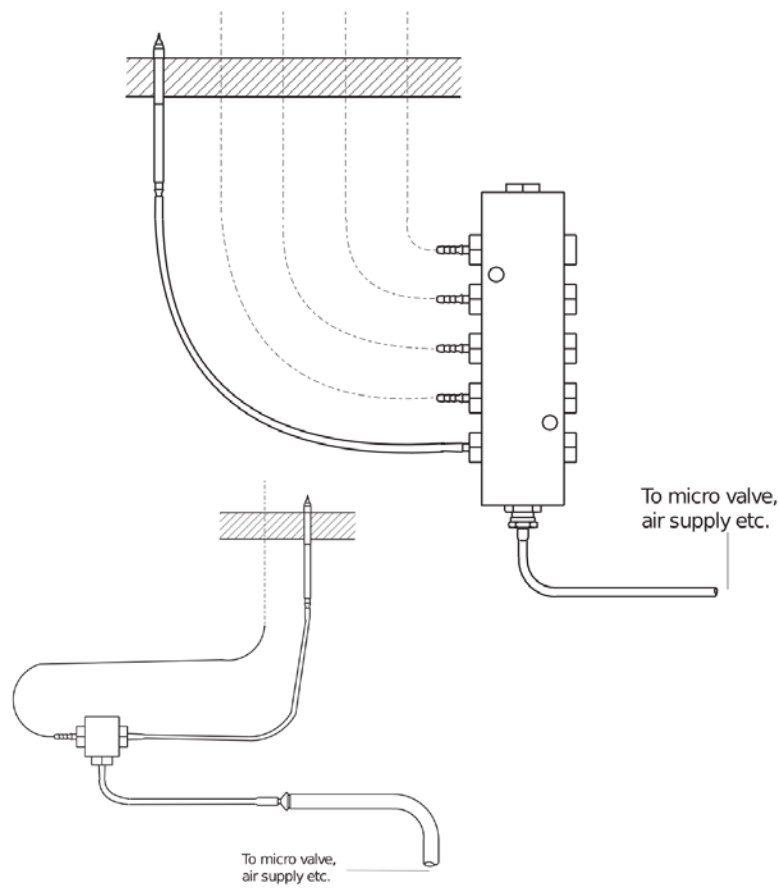

For this presentation, we have prepared a small test jig for the audience

1. Pneumatic probes
2. Air hoses
3. Distributor terminal
4. Valve unit

Test the functionality by pulling out the front plunger (by hand) – unfortunately we do not have a compressor here.



Conclusion

High Speed Digital Probing

- ❖ make sure to match the mechanical properties with high frequency behavior
- ❖ proper wiring is critical
- ❖ check impedance with TDR scope if possible
- ❖ if possible, use proper, designated RF / high speed digital probes

High Current Probing

- ❖ mostly the current ratings are only given for a one-probe installation
- ❖ multi-probe environments are complex, overheating is possible
- ❖ forced convection (vents might be necessary)
- ❖ even low currents (1 A and less) might be a nightmare for multi-probe setups

Sequential Pneumatic Probing

- ❖ fixtureless installations are possible
- ❖ easy method for lateral approaches (side contacting)
- ❖ step by step testing is made easier
- ❖ dual-stage contacting without the need for a dedicated dual-stage fixture



Appendix

Usefu literature

Reference	Bibliography item
[HUB04]	Huber&Suhner AG: HF Verbinder Handbuch. 2004
[HUB07]	Huber&Suhner AG: HF Koaxialverbinder - Hauptkatalog. Edition 2007 / 2008
[ING10]	Ingun: Test Probes Catalog 2010/2011. URL: http://www.ingun.com
[ING11]	Ingun: RF Probes Catalog 2011/2012. URL: http://www.ingun.com
[MAN12]	Mantaro: Impedance Calculators. URL: http://www.mantaro.com/resources/impedance_calculator.htm . Search term: Discrete Structures, effective 01-10-2011.
[MZ10]	Zapatka, Matthias, Dipl.-Ing.(FH). Passive HF Prüfkompnenten für den Produktionstestbereich. In: RadioTecC - Transmit & Test Solutions 2010. GEROTRON COMMUNICATION GmbH, 2010.
[ZZ09]	Zapatka, Matthias, Dipl.-Ing.(FH). ; Ziser, Ralf, Dipl.-Ing.(FH).: An Introduction to Coaxial RF Probing Solutions for Mass-Production Tests. In: ARFTG Conference Digest-Fall 74th. Broomfield, CO (USA), December 2009, p. 87 – 92