

Reduce Pollution of Process Gasses in an Air Reflow Oven

Gerjan Diepstraten
Vitronics Soltec B.V.
Oosterhout, Netherlands

Abstract

The introduction of lead-free solders resulted in a selection of different chemistries for solder pastes. The higher melting points of lead-free alloys required thermal heat resistant rosin systems and activators that are active at elevated temperatures. As a result, more frequent maintenance of the filtration systems is required and machine downtime is increased. Last year a different method of cleaning reflow ovens was introduced. Instead of cooling down the process gasses to condensate the residues, a catalyst was used to maintain the clean oven. Catalytic thermal oxidation of residues in the nitrogen atmosphere resulted in cleaner heating zones. The residues were transformed into carbon dioxide. This remaining small amount of char was collected in the catalyst. In air ovens the catalyst was not seen as a beneficial option because the air extracted out of the oven was immediately exhausted into the environment. When a catalyst is used in an air environment there is not only the carbon dioxide residues, but also water. When a catalyst is used in an air reflow oven the question is where the water is going to. Will it condensate in the process part of the oven or is the gas temperature high enough to keep it out of the process area? A major benefit of using a catalyst to clean the air before it is exhausted into the environment is that the air pollution is reduced dramatically. This will make environmental engineers happy and result in less pollution of our nature. Apart from this, the exhaust tubes remain clean which reduces the maintenance of air ovens. This paper will give more detailed information of catalyst systems during development and performance in production lines.

Introduction

A catalyst to clean a reflow oven is a unit that can be retrofitted on an existing oven in production or it can be installed in a new oven. The development and introduction of this new technology was a DFSS (Design for Six Sigma) project. This method is different from Six Sigma projects that are used for improvements of existing products and processes (continuous and incremental innovations). DFSS is used for new products and processes (non-continuous innovation). Catalytic thermal oxidation is a new process for cleaning reflow ovens. The project is divided into four blocks (IDOV):

1. Identify
2. Design
3. Optimize
4. Verify

DFSS strategy is used to make new products that support customer success. It starts with the customer needs and ends with customer satisfaction. Commercial and product quality is needed. Continuous data collection is essential for reaching the improvement goals. Where Six Sigma is all about using statistics for data driven improvement. It focuses on process characterization and process optimization. Continuous data will be essential for reducing variation and centering the process. This document follows the DFSS project steps and describes what activities, experiments, prototyping and customer introductions were done to finalize a catalytic thermal oxidizer for reflow ovens.

Phase 1: Identify – determine functional requirements

For traditional ovens the cleaning of the heating zones is done using a so called “GRS” (Gas Recirculation System). The GRS takes the hot gases out of the process zones and guide them through three heat exchangers placed in serial. These heat exchangers cool down the gas, and the flux residues in this gas will condensate into the metal filters that are placed in between the heat exchangers. This process results in condensation of flux. The amount of condensed flux depends on the production volumes. Gasses from board material, solder paste and chain lubrication condensate and result in a tacky oily residue. The first part of this project was to identify these chemicals in order to understand what the final design would need to clean. This was done in two steps:

- Analyze the residues that are found in the condensation unit
- Define the chemistry in the solder paste

The difference between the two is that the chemistry found in the GRS includes lubrication, outgassing of board material and components, where the second measurement only covers the flux. On the other hand, in the solder paste analyses, the focus was not only on one particular flux, but different chemistries were selected.

From the fluxes, the selection included rosin and resin based, low and high activated fluxes, as well as leaded and lead free chemistries. The experiments tried to cover all varieties in the market. The elements that were found, ranked by percentage, are listed in table 1.

Table 1: Chemistry in solder paste flux by amount [vol%]

Component	Amount present [vol%]	CAS #	Structure
Terpineol and isomers of	25	7299-40-3 562-74-3 98-55-5	
Tripropylene glycol monomethyl ether	20	20324-33-8	
Diethylene glycol hexyl ether	20	112-59-4	
Hexylene glycol	20	107-41-5	
1-Methyl piperidine	10	626-67-5	
1-Methyl-2-pyrrolidinone	5	872-50-4	

The final design of the unit should be able to get these elements out of the gas and return a clean gas into the oven. Since solder paste chemistry recipes are a supplier secret and there are thousands of pastes in the market, it is impossible to check them all out.

The first step in this project is to define the stakeholders and their needs. The method to identify the stakeholders and their needs was to understand the “Voice of the Customer”. Three methods were used to understand the customer’s needs:

- A survey
- Interview with several customers
- Brainstorm with customers and service engineers

In order to quantify the performance of the design the stakeholder’s needs should be able to be monitored. Customer’s wishes should be able to be confirmed with data. Therefore a CTQ flow chart (Criteria to Quantify) is made:

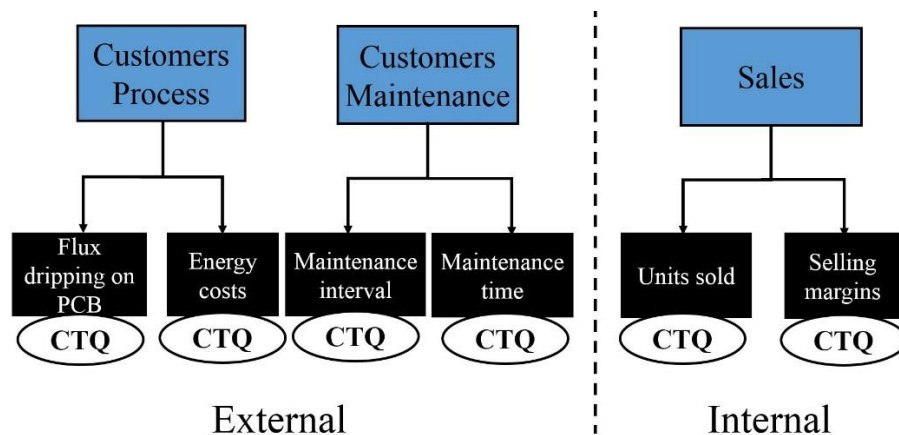

Figure 1: CTQ flow chart

Phase 1: Identify – translate into technical requirements

Three different methods are possible to filter chemistry residues out of the gas. The traditional method is listed more as reference for the new methods. This method cools the process gasses that have a temperature of 100 – 250 °C back to 40 °C or lower to let them condensate on metal and paper filters. This method requires quite a lot of maintenance since the flux that condensates is very tacky and filters may clog after a few weeks. Since the temperature of the gas cools down from over 100 °C the first filters are metals and only the last filter can be a paper/consumable one. The metal filters including the heat exchangers require cleaning. This can be done manually or in a cleaning machine. The temperature drop of the gas also requires quite a lot of energy. The alternative method is pyrolysis. Pyrolysis is decomposition of organic material at elevated

temperatures (>500°C) in the absence of oxygen; it is an endothermic reaction. The process cracks larger molecules into smaller ones. Char is generated. Thermal catalytic oxidation converts organic vapors to carbon dioxide and water in the presence of oxygen; it is an exothermic reaction at 200 °C.

	Process temperature [°C]	Energy costs	Cost of consumables	Maintenance interval	Maintenance time
Catalytic thermal oxidation	200	+	+	+	-
Condensation and filtration	20	-	-	-	-
Pyrolysis	500	-	+	+	-

Figure 2: Critical parameter management

Phase 1: Identify – create a business case

Basically two methods are interesting as an alternative for flux condensation. Pyrolysis is a method that is already introduced in reflow ovens. In this project pyrolysis is compared to thermal catalytic oxidation. Since it is a requirement to keep temperatures of the design close to reflow oven temperatures (minimize energy costs and waste) it was also investigated if pyrolysis could be done at lower temperatures with different granulates including zeolites and perlites.

Phase 2: Design – develop concepts

In this part of the design a number of brainstorm sessions were conducted to come up with different concepts and methods of measurement. A method called TRIZ was used. This looked into different processes in the industry where similar products and processes takes place. Catalytic thermal oxidation was found as a method that was used in the biochemical and petro chemical industries to clean gasses. The efficiency of catalysts to clean gasses at much lower temperatures and the long life cycle (up to 15 years) of this material makes it very interesting in a reflow application.

In this phase of the DFSS, project experiments are done to define the performance of the different alternative solutions. One major experiment was to define the efficiency of cleaning nitrogen. The reason to do this experiment in nitrogen is because the majority of the nitrogen ovens have a cleaning system for the gas, where in air ovens, recycling is not common. A thermogravimetric analyzer (TGA) was used to heat up a flux sample of solder paste. The gasses coming out of the paste, including the nitrogen gas from the TGA, were guided to a small cleaning device. After cleaned, a FTIR (**Fourier Transform Infrared Spectroscopy**) was used to measure the amount of VOC still in the gas. Or in other words it was able to calculate the efficiency of the cleaning device. This experiment was done at a temperature of 225 °C on the cleaning device. The flow rate of the nitrogen was 50 ml/min.

Table 2: cleaning capability different concepts for solder paste sample 1.

	Absorbers (Pyrolysis)					Catalytic thermal oxidation	
	Granulate1	Zeolite 1	Granulate 2	Perlite	Zeolite 2	Catalyst 1	Catalyst 2
Cleaning efficiency [%]	69	79	69	69	12	100	100

For both catalysts no organics were present after the gas passed the catalyst. Further tests were done on both catalysts to identify if there was a performance difference between them.

Table 3: Performance difference of the two catalysts

		Catalytic thermal oxidation	
Solder paste	Temperature	Catalyst 1	Catalyst 2
sample 1	225 °C	Pass	Pass
	185 °C	Pass	Fails
sample 2	225 °C	Pass	Fails
sample 3	225 °C	Pass	Fails

Catalyst 1 had a wider process window and was able to clean all of the pastes even at lower temperatures. The main difference between the two catalysts was that number 1 had a 5 times thicker nano coating.

Phase 2: Design – establish a high level design

Before building a prototype the right concept has to be chosen. A Pugh matrix method was used to weigh the alternatives. The alternatives are compared to a baseline which is today's GRS system.

Table 4: Pugh matrix showing that Catalyst 1 is the favorite design

	Absorber Granulate 1	Catalyst 1	Baseline: GRS system
Flux dripping risk	0	0	0
Energy costs	+1	+2	0
Maintenance interval	+2	+2	0
Maintenance time	+1	+1	0
Costs per unit	0	0	0
Totals	+4	+5	0

The different designs are measured against the CTQs. Since the catalyst requires less operation temperature there is an advantage in comparison to the Pyrolysis with granulate, and its cleaning performance is also better.

A prototype was built to verify the working of a catalyst in a real reflow oven. The technology from the lab was transferred to a device that was connected on a reflow oven. To measure the performance of the catalyst a baseline test was done with a GRS (condensation cleaning) unit. To accelerate oven contamination solder paste flux was used from two different suppliers. As solder paste is only 10% flux and 90% solder powder, using flux only is more efficient. A Design of Experiment was done using two different pastes, conveyor speeds, reflow profiles (linear versus ramp soak spike) and different fan speeds. The objective of this experiment was to identify what parameter settings were ideal for fast contamination.

Table 5: Design of Experiment to define what influence solder paste flux evaporation

Design of experiment - evaporation			
Parameter		Level 1	Level 2
Solder paste		ROLO	RELO
Conveyor speed	cm/min	80	120
Reflow profile		RSS	Linear
Fan speed	Hz	40/60	50/50

The analysis of this experiment showed that the solder paste flux has the most impact. The Rosin based flux evaporated more than the Resin. Also the linear profile had more outgassing.

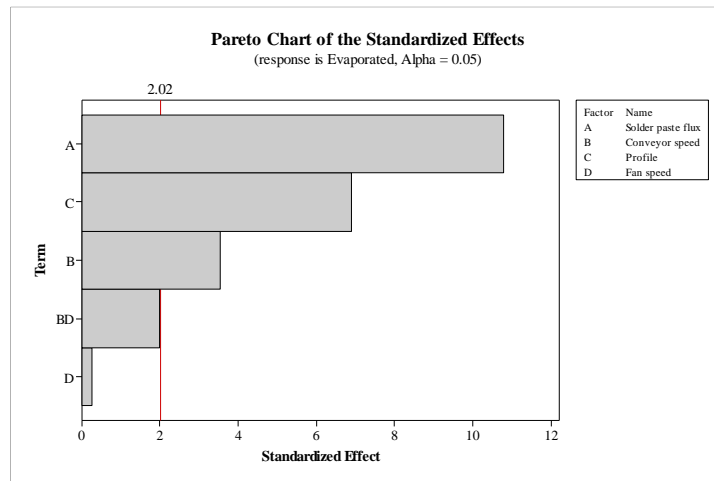

Figure 3: The Pareto chart shows the factors with significant impact on outgassing

The settings were used for the final experiment. For this experiment aluminum foils were placed on PCBs filled with approximately 100 grams of flux. In these runs the concentration of vapors in the nitrogen or air was 6.0 grams per m³. In production this is approximately 20x less 0.3 gram per m³. The experiments in the lab had 3.6 gram per m³. For a baseline the oven ran 2 kg of solder paste flux. After that the GRS condensation system was taken apart and contamination was monitored.

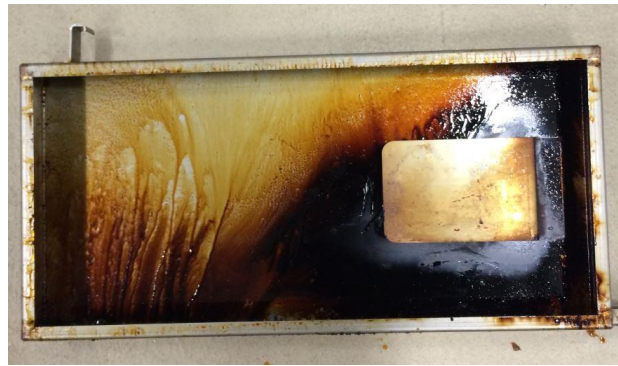

Figure 4: Condensation of ROL0 flux in the GRS system (2kg)

All parts were cleaned and the catalyst unit was placed in front of the GRS. The test with the flux was repeated in nitrogen with solder paste flux ROL0. The nitrogen was exhausted out of the reflow and guided through the catalyst. From the catalyst the cleaned nitrogen was condensated in the GRS. After 2 kg of solder paste flux the condensation was again monitored.

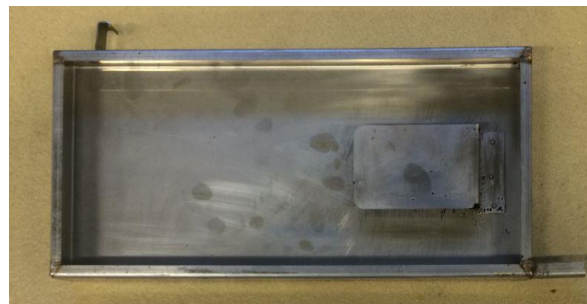

Figure 5: Condensation of ROL0 flux after the catalyst (2 kg)

There was a difference between running the test in air versus nitrogen. In a nitrogen environment the catalyst produces carbon dioxides only. Where in air, in addition to carbon dioxide water is also formed. This water was found in the GRS system where it condensates.

Phase 2: Design – design review

The experiments proved that the catalyst also works in a reflow environment. The test prototype was oversized and a new design was required. The goal was to keep the oven as clean as possible with the smallest catalyst configuration. Each long connection tube out of the reflow oven to the catalyst is a potential place for condensation/contamination. For this reason the team decided to have all zones in an individual catalyst with a small connection to avoid temperature drop.

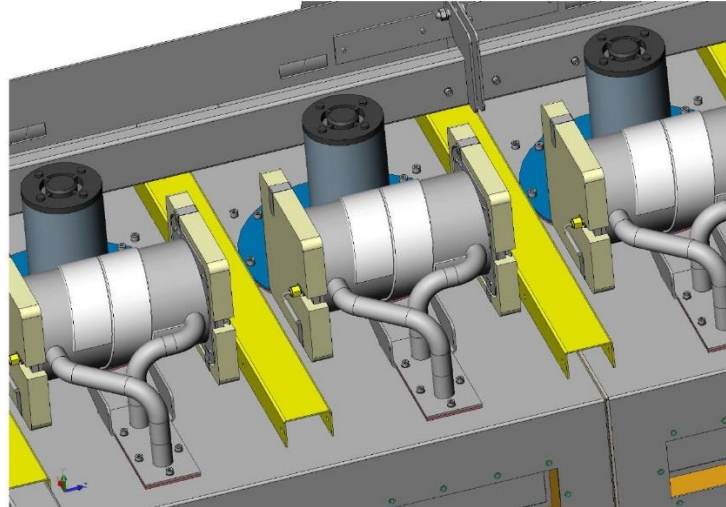

Figure 6: Each zone has its own catalyst.

Due to the over pressure in the heating box the nitrogen will flow through the catalyst and is guided back into the zone. The flow rate depends on the frequency of the fan and is 16 m³/h at 40 Hz and 20 m³/h at 60 Hz. This flow is approximately 5% of the total flow in the heating box. For this reason the temperature of the zone is not influenced by the catalyst temperature (200 – 250 °C) and the flow is still enough to clean the gas.

Phase 3: Optimize – analysis

The first oven was retrofitted with catalysts on all heating zones in a full production line. The oven ran boards in 3 shifts. A lot of data was recorded with respect to number of boards soldered and amount of solder paste consumed. Before the evaluation started the oven was cleaned and new face plates were mounted.

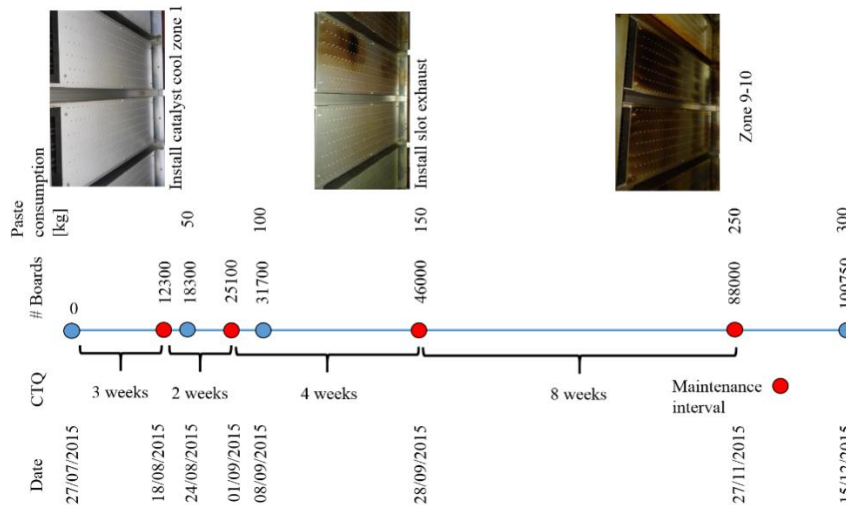

Figure 7: shows the maintenance intervals over 5 months

During the evaluation the system was modified with some new features to extend the maintenance interval. The installation of a catalyst on the first cooling brought a slight improvement. The interval was extended significantly when a slot exhaust was installed with a catalyst. A venture sucks the contaminated gas out of the process area between the last peak and first cooling zone. Not only did the maintenance interval improve, but the maintenance time was also reduced.

The baffles are cleaner as before, and the gas recirculation system (flux condensation unit) is completely removed so there is no cleaning of filters and unit anymore.

Phase 3: Optimize – determine optimal settings

Apart from these machine settings there is a chemical difference between an air and nitrogen reflow environment. The water tends to condensate in the first and second cool zone. This requires a different concept. After the air is exhausted through the catalyst it goes into the environment and isn't returned into the oven to avoid excessive moisture in the cooling. The air is cleaned but in the tubes there is a small black film, where in nitrogen ovens the tubes have a small white colored film generated by the silicone tube.

Phase 3: Optimize – determine tolerances

The minimum temperature for the catalytic thermal oxidizer is 185 °C. The maximum operation temperature is defined by the materials that are used and is limited to 300 °C. Sealing and tubes have temperature limitations. The catalyst should not influence the temperature of the zone. 5% of the circulated gas runs through the catalyst at a higher temperature than the zone has. The best setting for the catalyst is a temperature approximately 50 °C higher than the zone temperature. This temperature should be higher than 200 °C. PID (Proportional Integral Derivative) settings for the catalyst heaters are optimized. The heating up time of the catalyst should not affect the oven up time. Some SMD (Surface Mount Device) lines run lead-free, tin lead and curing profiles on one line. Since the set points are significantly different for these profiles it is a challenge to find the right PID settings.

The capacity of the catalyst is enough to serve two heating zones. This benefits the internal CTQs. Combining two zones for one catalyst impacts the pricing a lot. It is critical that there is no bias flow from one zone to the other and that temperatures in the zones are not influenced.

Phase 4: Verify – Capability analysis on test runs

The catalyst was installed in the first series of ovens. Multiple ovens were fitted with catalysts to verify the performance in a production environment. These ovens were older ovens where the catalyst was installed to replace a GRS system or new ovens. The ovens used were different lengths (from 9 to 12 heating zones) and included inert as well as air ovens. Important for all these configurations was that the required temperatures for the catalyst were consistent through the entire production.

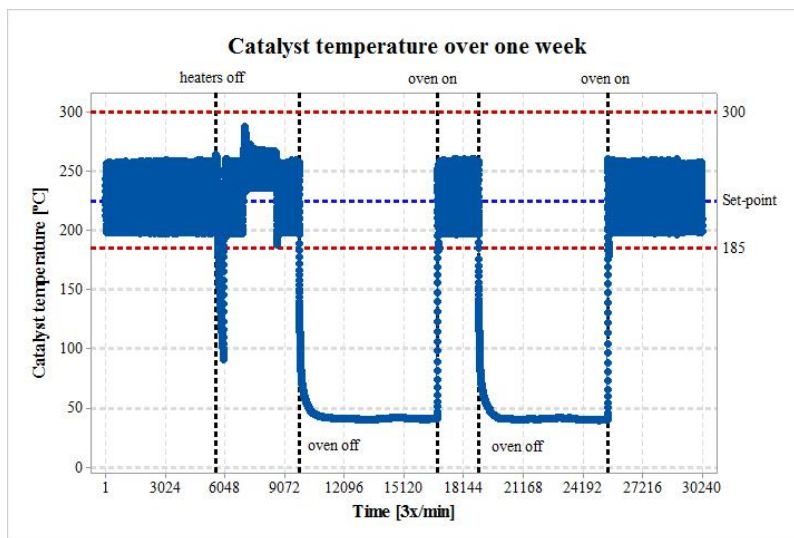

Figure 8: The temperature of the catalyst over time (in total one week)

Different process conditions resulted in different levels of contamination. The amounts of solder paste used influenced the maintenance interval. Some ovens consumed 2 kg per week whereas other production lines produced a lot more; up to 40 kg per week. This resulted in different maintenance intervals varying from every 14 days up to 10 weeks or more. The average consumption of paste was 12.5 kg per week with a maintenance interval of 4 weeks.

Phase 4: Verify – Design quality control systems

The catalyst itself does not need statistical process control. The only parameter that should be controlled for the catalyst is its temperature. This parameter is monitored on the screen and logged in the trends. When the temperatures for some reason are out of the upper or lower limit, alarms will show up and the oven is stopped to avoid damage. Most SMD lines have manual or automatic inspection equipment. Defects are monitored continuously. The worst-case scenario is when flux starts to drip from the cooling or baffle zones onto the PCB. There should be an OCAP (Out of Control Action Plan) that describes what to do. Most likely heat exchangers or face plates needs to be replaced because of too much time without maintenance.

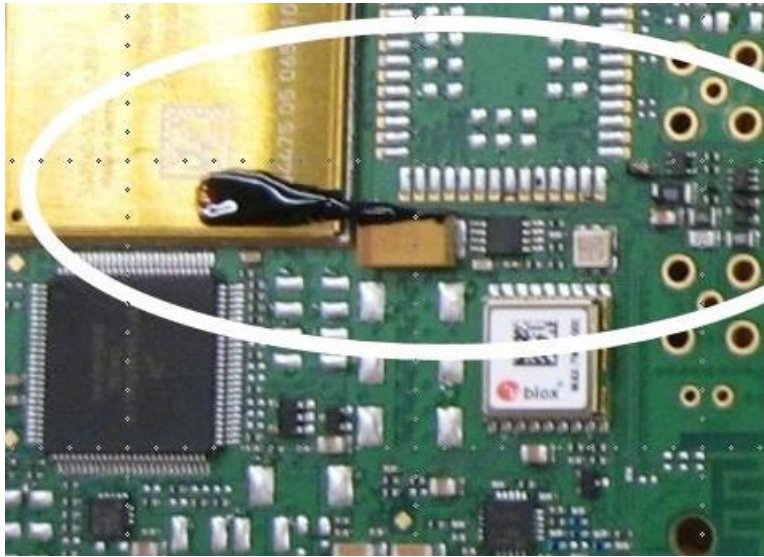

Figure 9: A droplet of flux residues found on the assembly. (Indicator for a lack of maintenance)

Phase 4: Verify – Project closure and transfer

After finalizing the design and releasing it for sales, the project was closed and responsibilities were handed over to the other stakeholders, sales and service managers. All small changes to improve the system were done by the engineering department as small improvement projects or customer specific requirements.

Conclusions

A catalytic thermal oxidation unit has been designed and implemented in SMD lines successfully using the Design for Six Sigma project methodology. A catalyst is an excellent device to crack the carbon molecules at a low temperature of approximately 225 °C. This temperature is ideal for cleaning reflow process gasses that have similar temperatures in the process zones. The returning gasses from the catalyst are clean and have no impact on the reflow process temperatures of the zones.

The pyrolysis responds differently in an air and nitrogen environment. In nitrogen the returning gasses are clean and dry which makes it possible to recycle the nitrogen in the oven and have a reduced nitrogen consumption. In air ovens the air coming out of the catalyst is wet. Returning this gas back into the oven would condensate in the baffles. In air ovens the gas is exhausted into the environment after being cleaned by the catalyst.

General References:

1. "Effective methods to get volatile compounds out of reflow process." IPC APEX 2014 – Gerjan Diepstraten
2. "Roadmap DFSS (Design for Six Sigma)", IBIS University of Amsterdam, Prof. dr. Ronald J.M.M. Does
3. "Quality quandaries: Design for Six Sigma: Method and application", J. de Mast, G. Diepstraten, R.J.M.M. Does, Amsterdam School of Economics Research Institute (ASE-RI), 2011

Reduce Pollution Of Process Gasses In An Air Reflow Oven

Design for Six Sigma

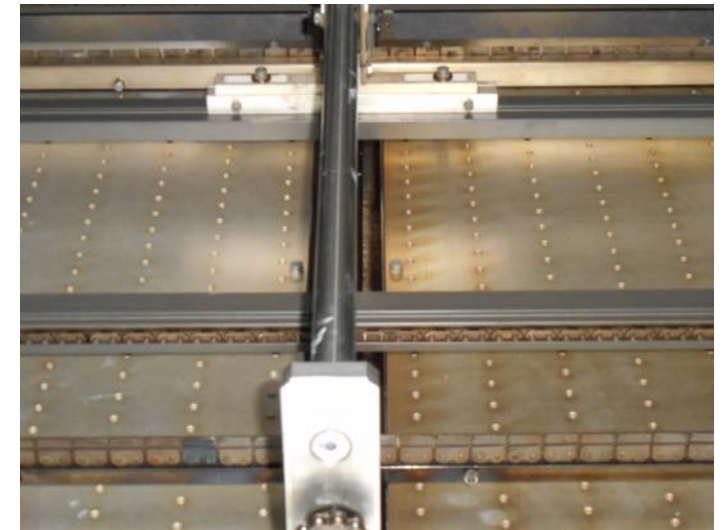

Gerjan Diepstraten
Vitronics Soltec BV

Define for Six Sigma Project:

Project steps (different from Six Sigma projects):

- Identify
- Design
- Optimize
- Verify

A typical Six Sigma project:

- Design
- Measure
- Analyze
- Improve
- Control

DFSS strategy is used to make new products that support customer success.

Six Sigma is all about using statistics for data driven improvement.

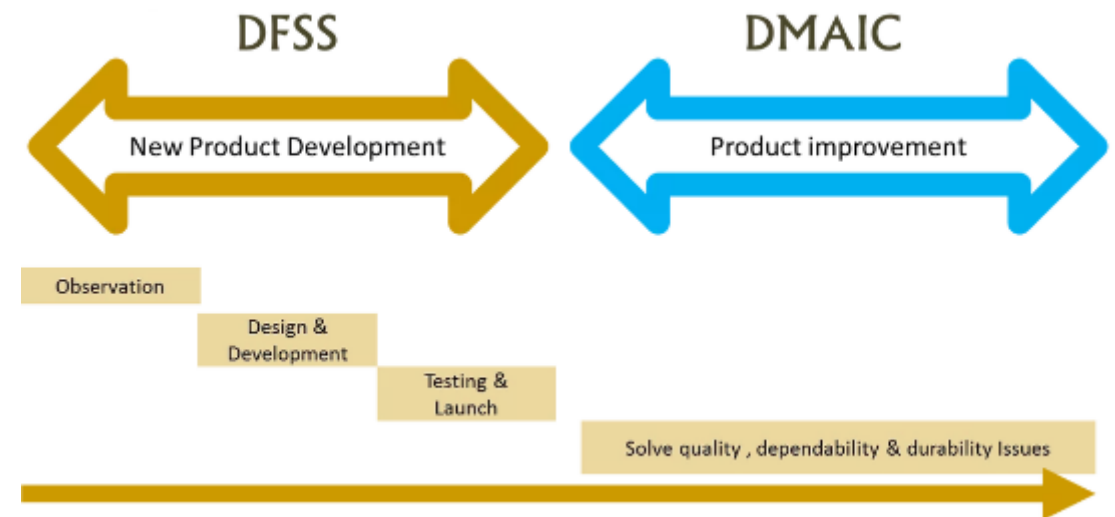

Phase 1: Identify – determine functional requirements

Gasses from board material, solder paste and chain lubrication condensate and result in a tacky oily residue. The first part of this project was to identify these chemicals:

- Analyze the residues that are found in the condensation unit
- Define the chemistry in the solder paste

Parameter	Abprodukt Reflowofen
lfd.-Nr.: IE-Analytik GmbH	51638
Screening auf leicht- bis schwerflüchtige organische Komponenten	Leicht flüchtige Verbindungen nicht nachweisbar
Stoffklassen- und Stoffinventar qualitativ	Mittel und schwer flüchtige Stoffklassen: - sauerstoffhaltige Verbindungen * Alkohole * Aldehyde * Ketone * Ether * organische Säuren * Säureester * Phenole - Kohlenwasserstoffe - Terpenartige Verbindungen - Aromaten - Stickstoffverbindungen - Phosphorverbindungen - Bromverbindungen siehe Anlagen Screening-Stoffinventar/-identifizierungen

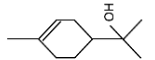
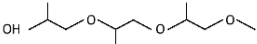
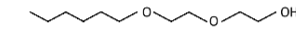
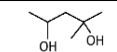
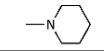
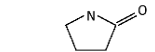
Component	Amount present [vol%]	CAS #	Structure
Terpineol and isomers of	25	7299-40-3 562-74-3 98-55-5	
Tripropylene glycol monomethyl ether	20	20324-33-8	
Diethylene glycol hexyl ether	20	112-59-4	
Hexylene glycol	20	107-41-5	
1-Methyl piperidine	10	626-67-5	
1-Methyl-2-pyrrolidinone	5	872-50-4	

Phase 1: Identify - stakeholders

Understand “Voice of customer”:

- Survey
- Interviews with customers
- Brainstorm with service engineers

Monitor stakeholders needs: CTQ

Criteria to Quantify

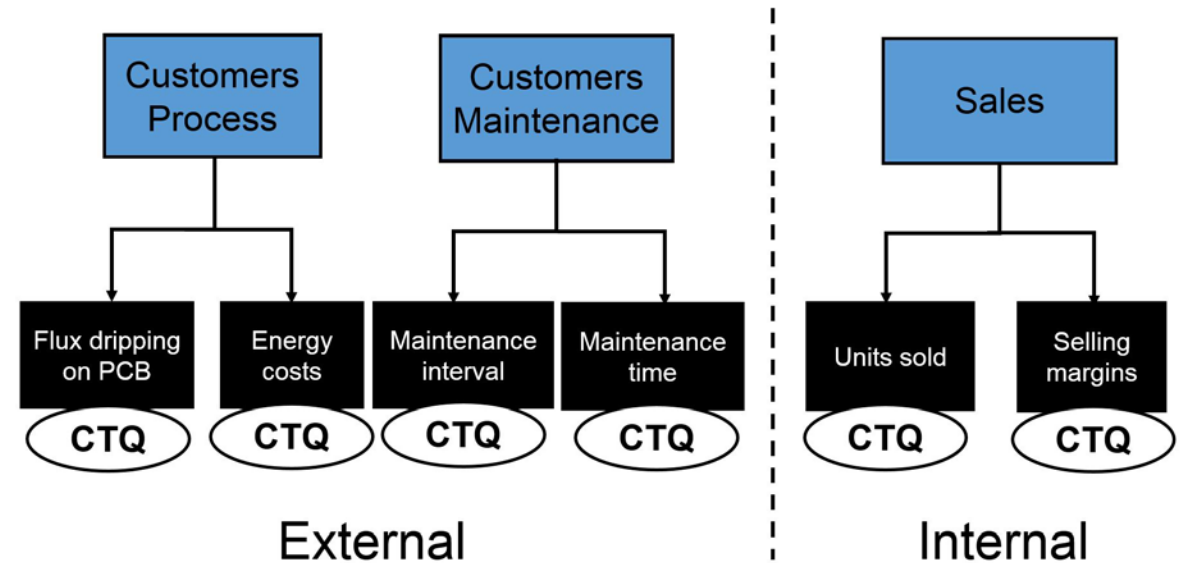

Phase 1: Identify – translate into technical requirements

Three different methods are possible to filter chemistry residues out of the gas.

- Condensation and filtration:
Traditional method cools down to 40 °C and filters residues
- Pyrolysis:
Method used in modern ovens but requires > 500 °C
- Catalytic thermal oxidation:
Potential new feature requires less heat.

	Process temperature [°C]	Energy costs	Cost of consumables	Maintenance interval	Maintenance time
Catalytic thermal oxidation	200	+	+	+	-
Condensation and filtration	20	-	-	-	-
Pyrolysis	500	-	+	+	-

Phase 1: Identify – create a business case

Basically two methods are interesting as an alternative for flux condensation. Pyrolysis is a method that is already introduced in reflow ovens. In this project pyrolysis is compared to thermal catalytic oxidation.

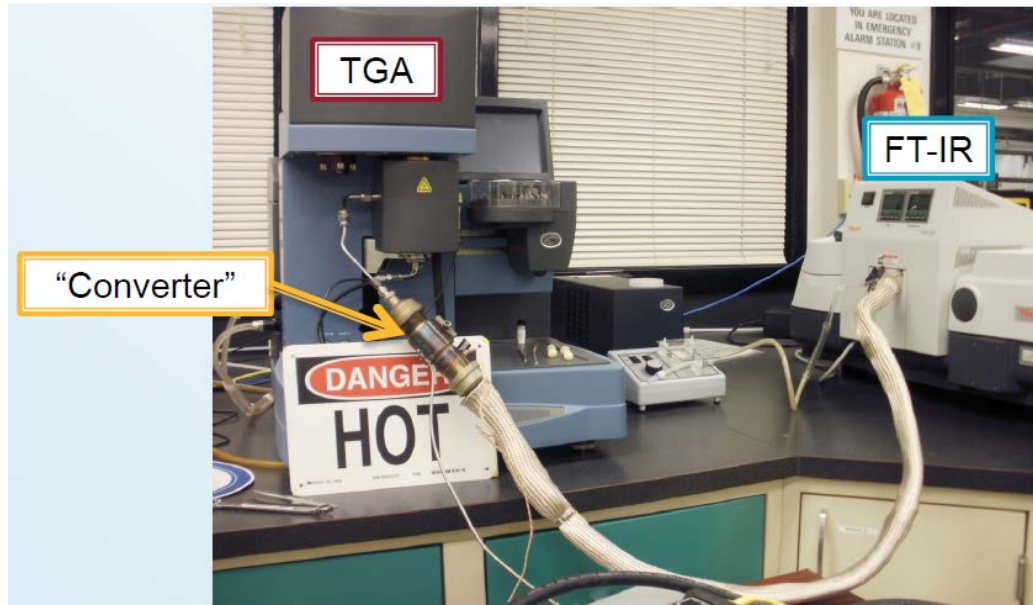

Adsorber	Weight of adsorber [g]	Amount of vapor evolved [mg]	Intensity of signal	Intensity per mg of vapor evolved	Reduction
Blank (baseline)	NA	6.35	0.027	0.0042	----
Granulate 1	0.65	4.40	0.006	0.0013	69 %
Zeolite 1	2.05	4.50	0.004	0.0009	79 %
Granulate 2	2.40	6.27	0.009	0.0013	69 %
Zeolite 2	2.66	4.86	0.018	0.0037	12 %
Perlite	0.39	4.56	0.006	0.0013	69 %



Granulate 1



Zeolite 1



Granulate 2



Zeolite 2



Perlite

Phase 2: Design – develop concepts

- TRIZ (теория решения изобретательских задач) method applied

Catalytic thermal oxidation was found as a method that was used in the biochemical and petro chemical industries to clean gasses and kitchen ovens



Reference [1]



Reference [2]

Catalyst principle

Catalytic thermal oxidizers decompose volatile organic compounds and gas pollutions.

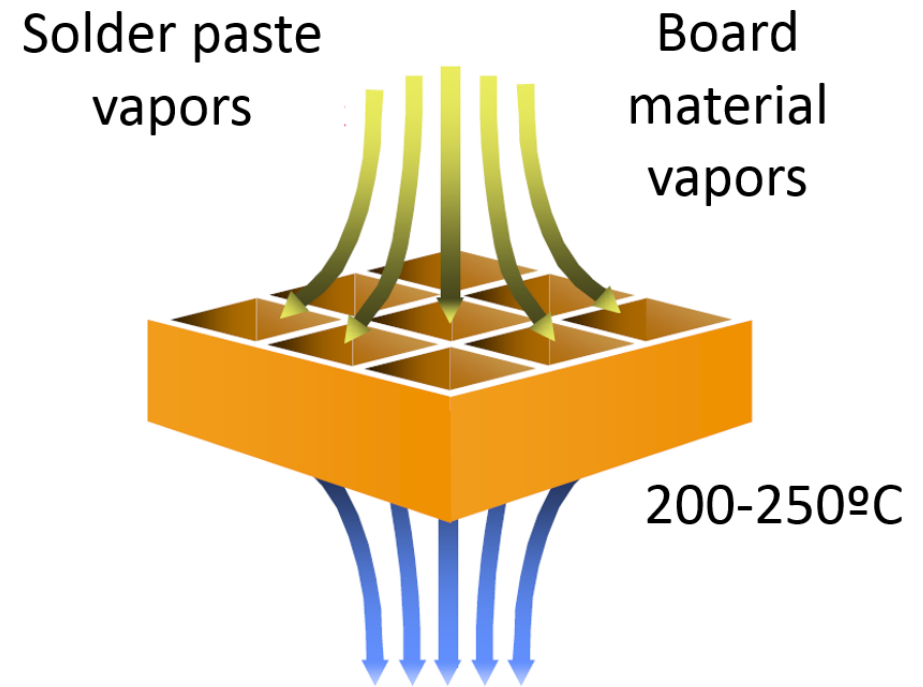

Process gasses in the reflow oven are decomposed at temperatures close to the reflow zone set-points

Phase 2: Design – establish a high level design

A Pugh matrix method is used to weigh the alternatives. The alternatives are compared to a baseline which is today's GRS system.



Granulate after and before pyrolysis at 500 °C

	Absorber (granulate)	Catalyst 1	Base line: GRS system
Flux dripping risk	0	0	0
Energy cost (temp's)	+1	+2	0
Maintenance interval	+2	+2	0
Maintenance time	+1	+1	0
Cost per unit	0	0	0
Total score	+4	+5	0

Phase 2: Design – first prototype

From laboratory to reflow oven

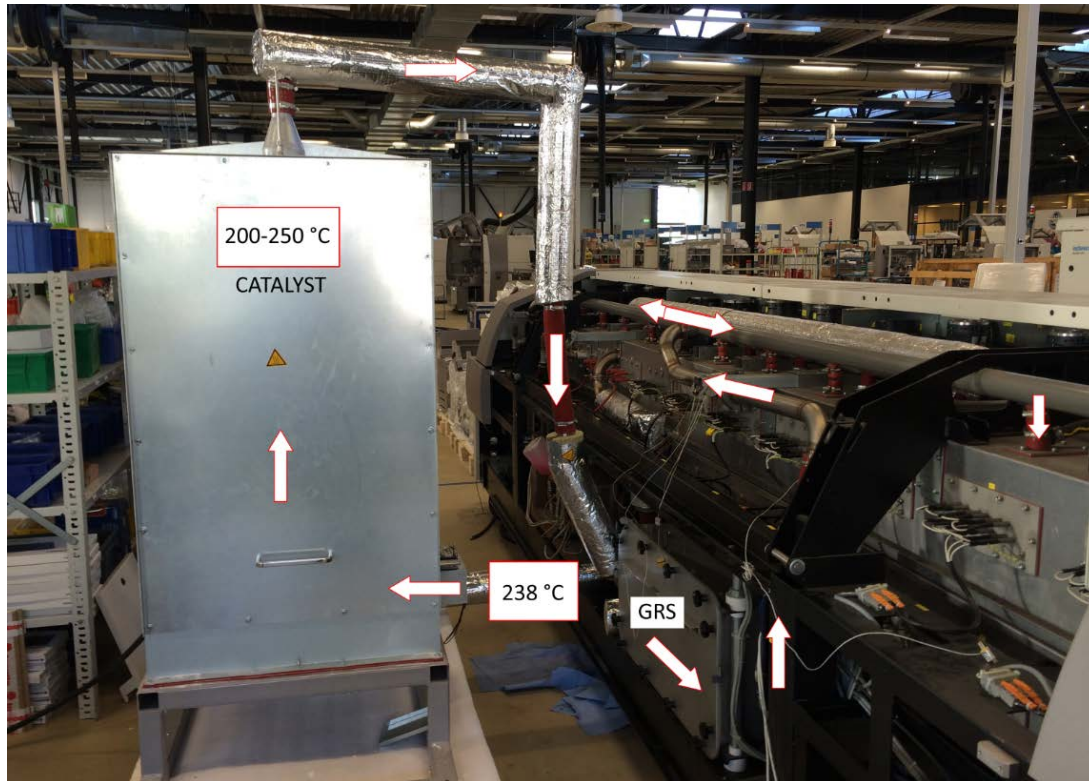

No catalyst

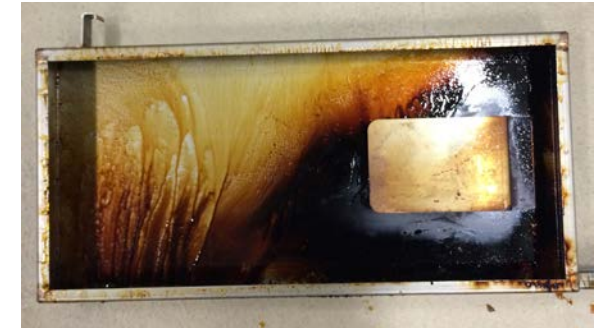

Catalyst
air oven



Catalyst
nitrogen
oven



Phase 2: Design – design review

The test prototype was oversized and a new design was required. The goal is to keep the oven as clean as possible with the smallest catalyst configuration.

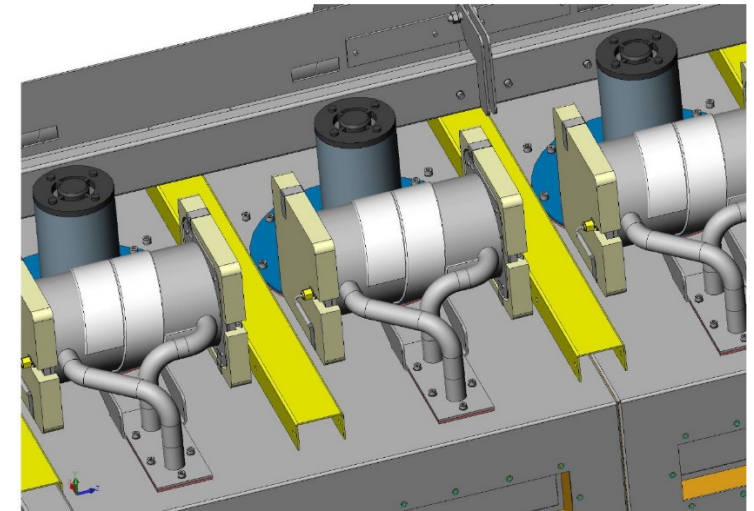
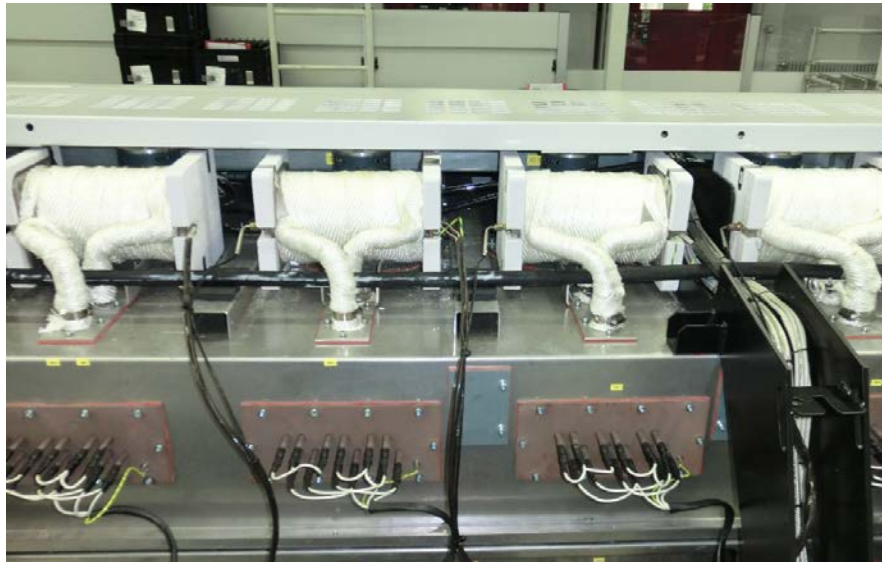

Every single zone has a catalyst.
System was implemented on an existing nitrogen oven
in production environment.

Single zone catalyst

Overpressure due to gas circulation by the blowers makes the gas flow through the catalyst.

The amount of gas depends on the blower speed.

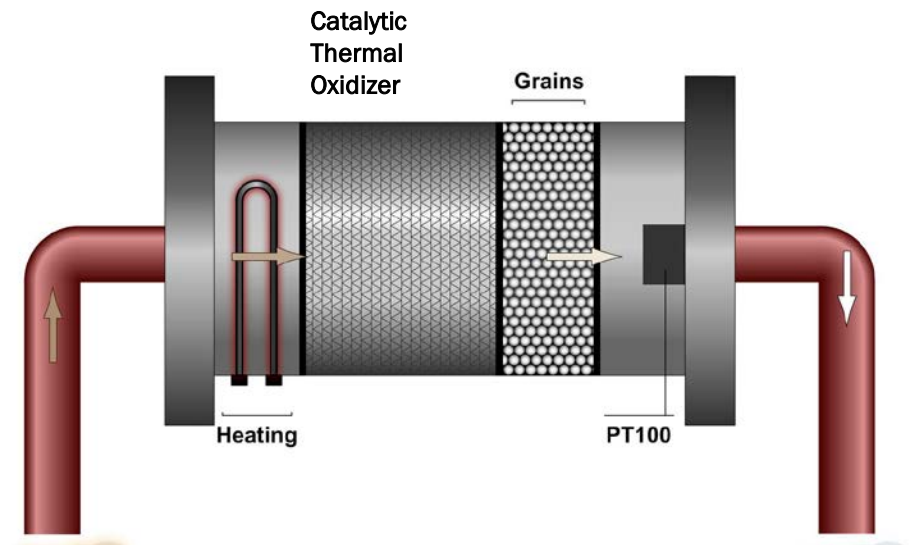
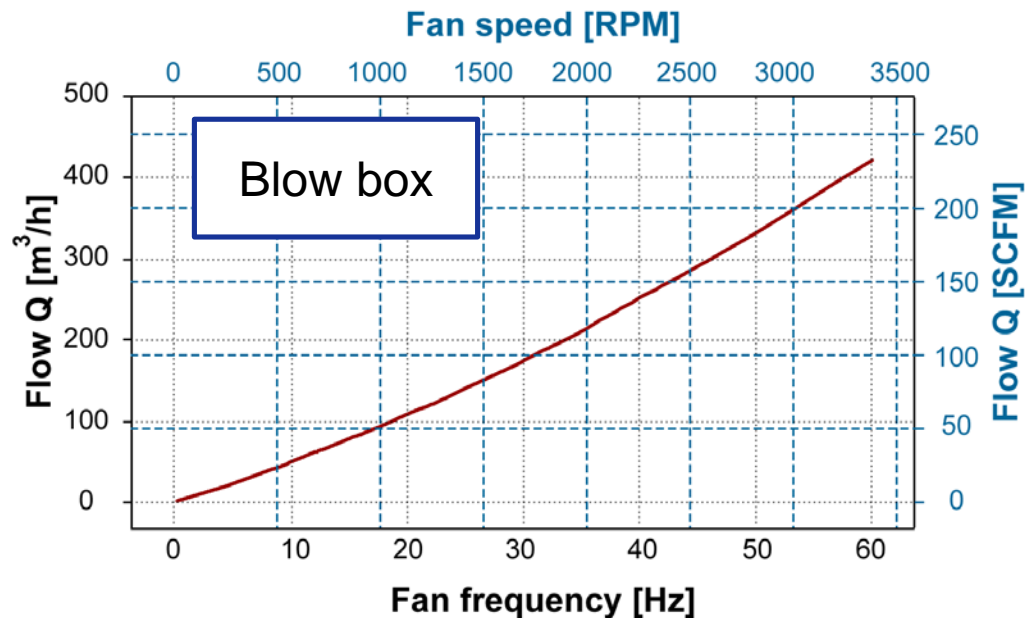

5 % of the flow passes the catalyst

Nitrogen balance in oven and catalysts

There must be a balance in the nitrogen flow in the oven. The catalysts should not influence this.

- Gas from zone 2-3 is cleaned by catalyst and purged into entrance baffle.
- Nitrogen purged in venture of slot exhaust. Via catalyst to exit baffle.

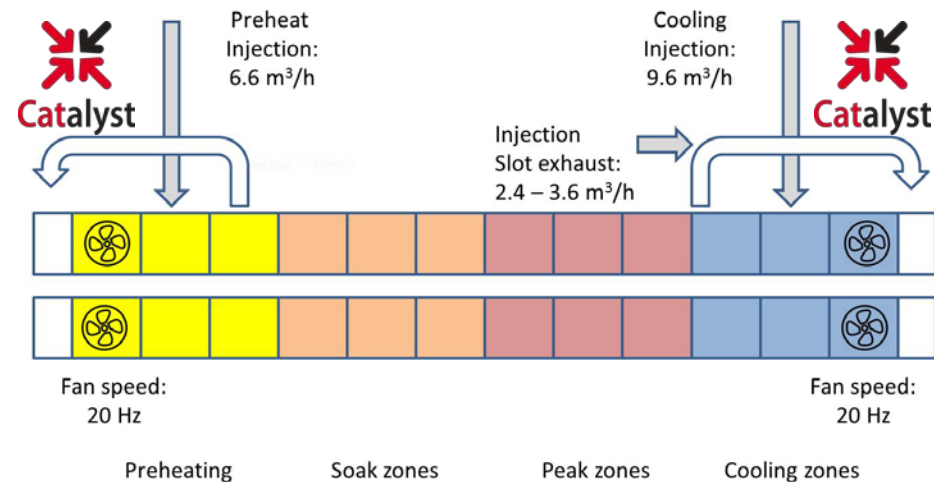

Catalyst enables use of lambda sensor

- Chemistry of solder paste may damage sensitive sensor
- With catalyst no filter is required, fast response of sensor
- Position of sensor is in the peak zone (outside the box) after catalyst

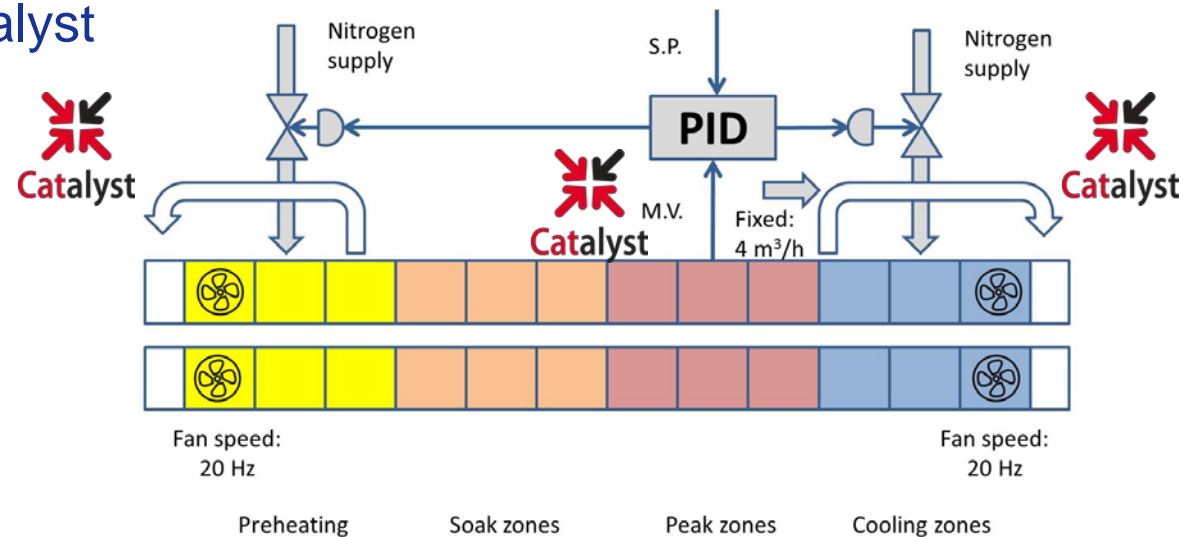

Closed loop nitrogen control with catalysts

Phase 3: Optimize – analysis

During 5 month period data was recorded:

- Consumed solder paste
- Soldered number of boards
- Maintenance interval

Maintenance:
Exchange heat exchanger and
face plate first cooling zone

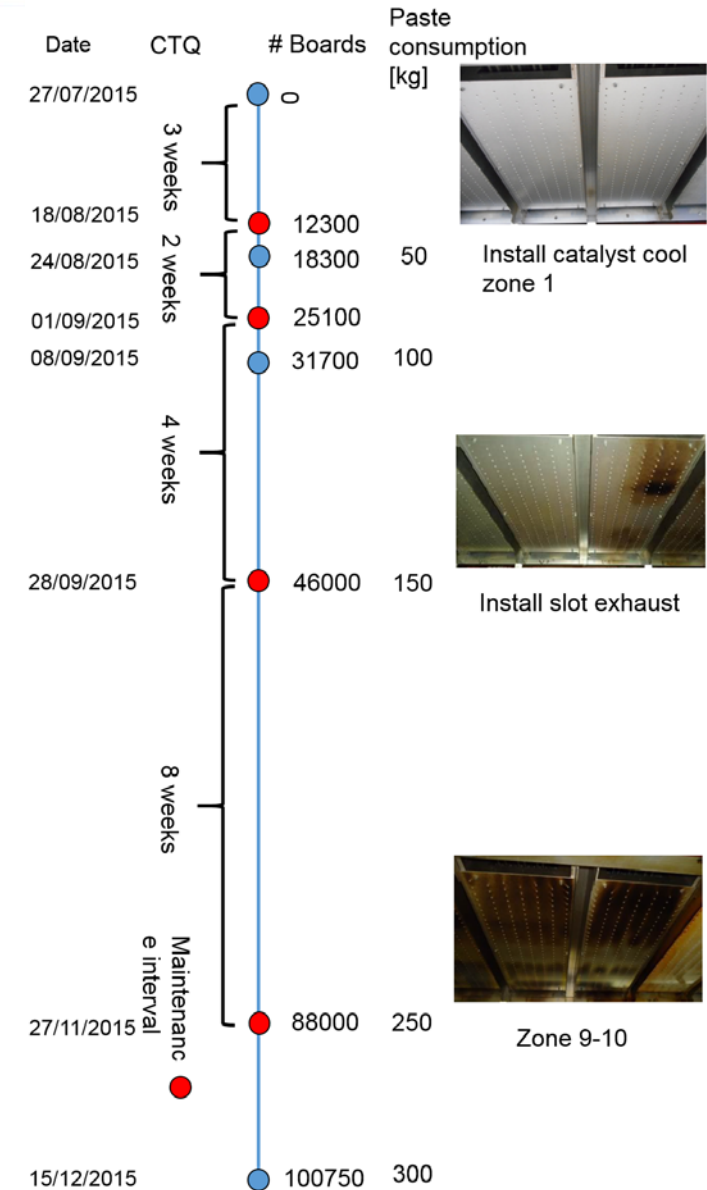

Catalyst in slot exhaust

Slot exhaust is installed between last peak and first cooling zone.

Venture installed to suck the process gas out of the oven.

In nitrogen ovens returned into exit baffle

In air oven returned into exhaust system

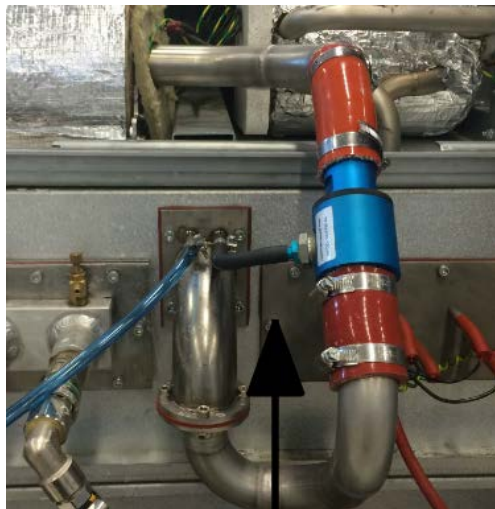

Preheat purged gas/N₂

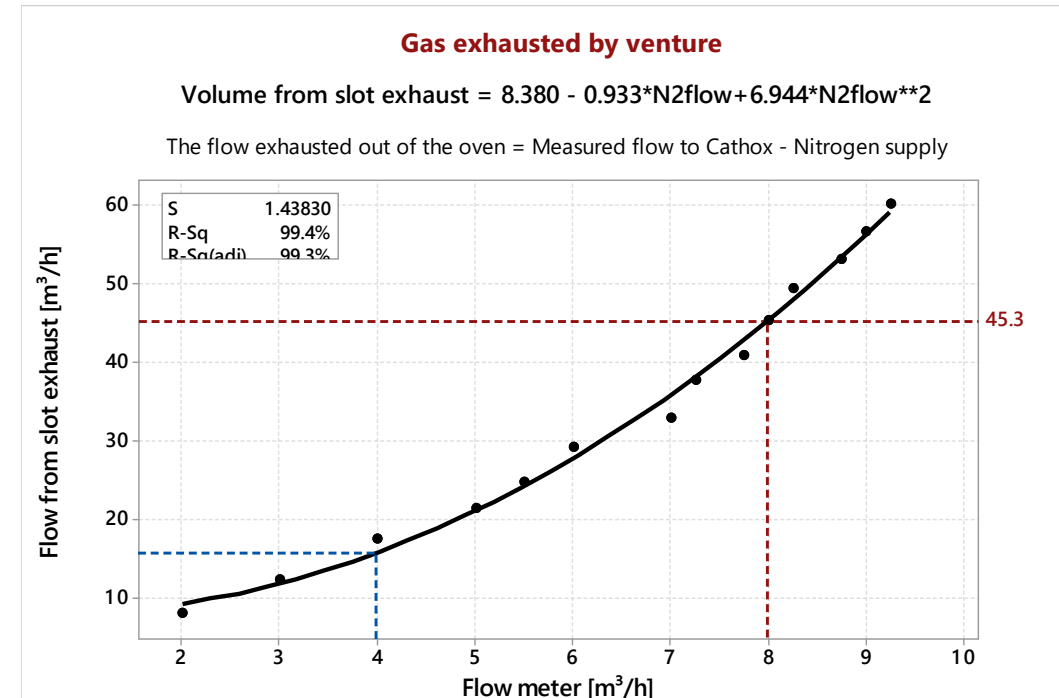

Phase 3: Optimize – determine optimal settings

Optimal configuration of catalysts in the oven.
TGA defines where solder paste evaporates.

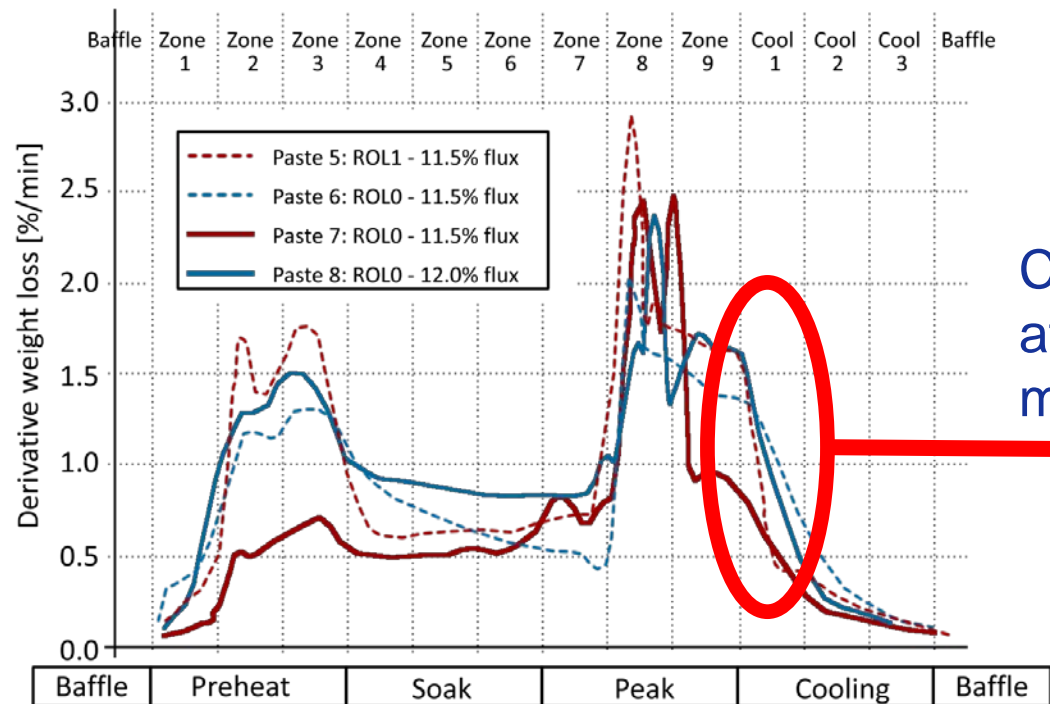

Blower zone 7



Contamination
after 10 years
mass production

Blower cool
zone 1



Process temperatures for catalyst

Minimum set-point 185 °C (defined in the lab)

Requirements:

- High enough to enable pyrolysis
- Should not affect the thermal profile
- Time to temperature should not affect start-up time oven
- Time to temperature should not affect recipe change over time

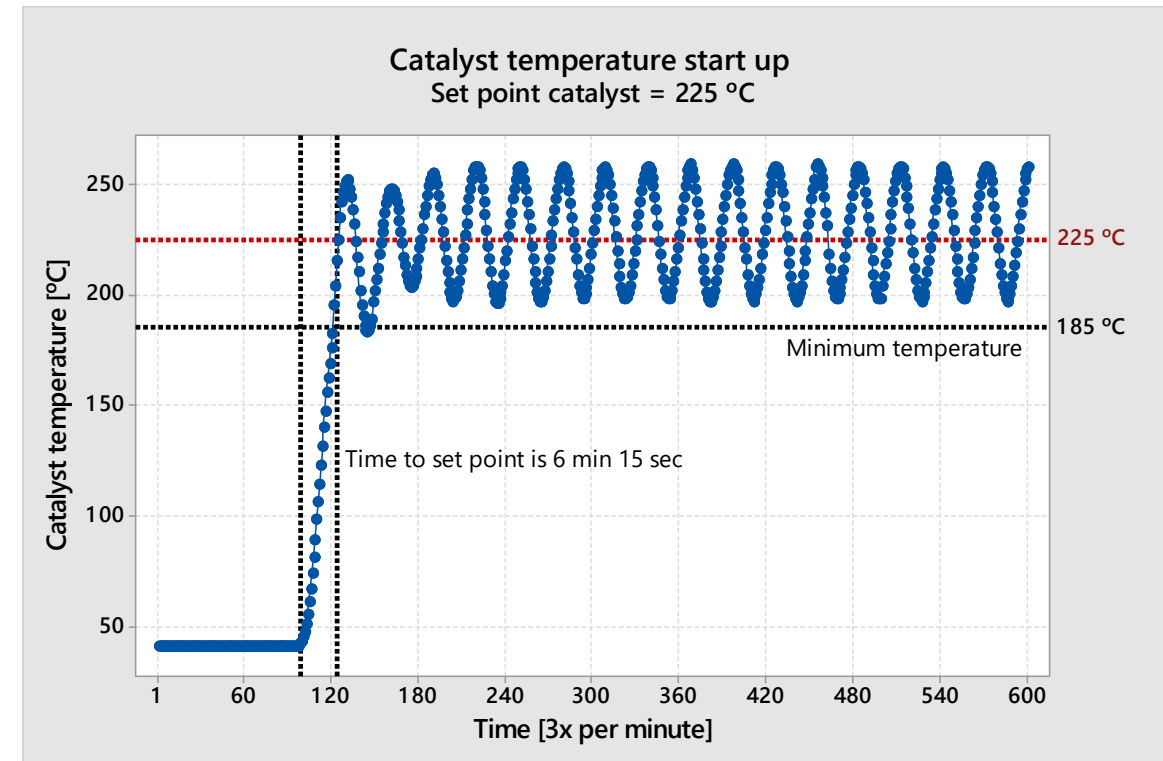

Phase 3: Optimize – determine tolerances

Capability of the catalyst is enough to combine two zones per catalyst.

Two zones per catalyst:

- Reduce purchase costs
- Equal flow to both zones
- Zone temperatures should not be influenced

Measure flow from and to catalyst
The two zones should have same
fan speed



Phase 4: Verify – Capability analysis on test runs

Different process conditions resulted in different levels of contamination. The amounts of solder paste used influenced the maintenance interval.

Gasses condensate/contaminate the oven. The critical area are the cold spots:



Infeed baffles



First cool zone (s)



Exit baffles

Potential risks

Pareto chart showing issues of 50 installed ovens

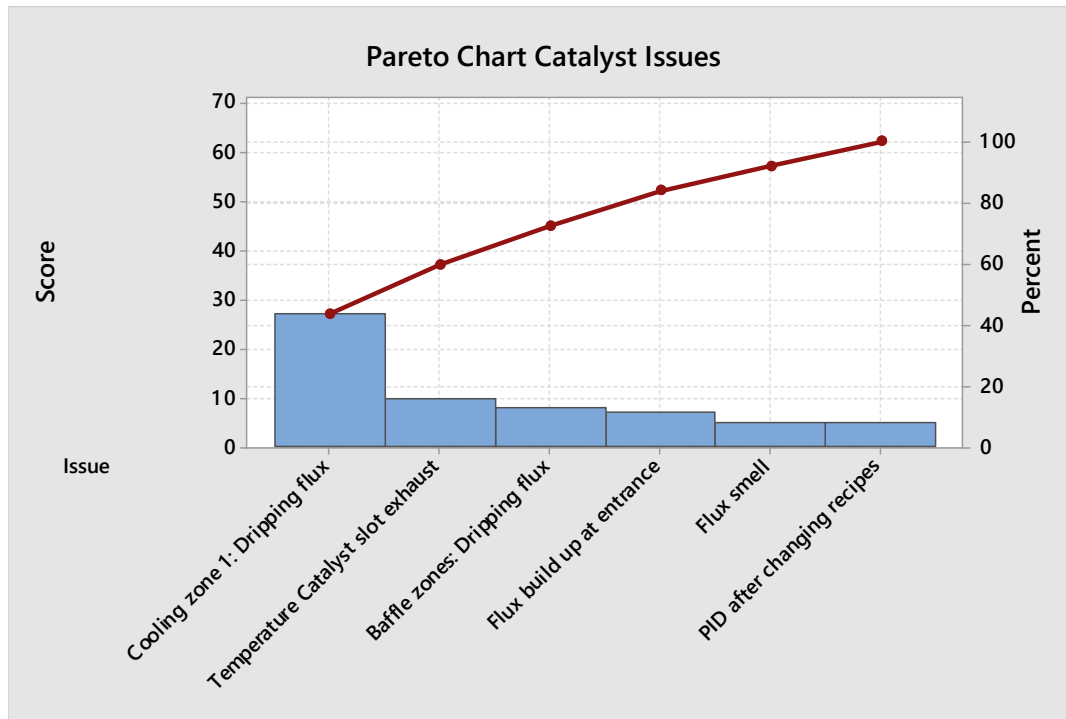

High contaminate ovens: catalyst in first cool zone

Heavy contamination in the process area can be reduced by combination of slot exhaust and catalyst in first cool zone.



After 6600 boards without
slot exhaust



With slot exhaust and catalyst in
first cool zone after 8100 boards

Difference air and nitrogen ovens

- During the pyrolysis in air environment not only hydro carbons but also water as residue.
- In air more contamination in cool zones (2 – 3) and baffles



Nitrogen environment:
Hydro carbons



Air environment:
Hydro carbons and water

Inspection catalysts after 6 months

- Chinese automotive application 1000 kg in 6 months
air oven

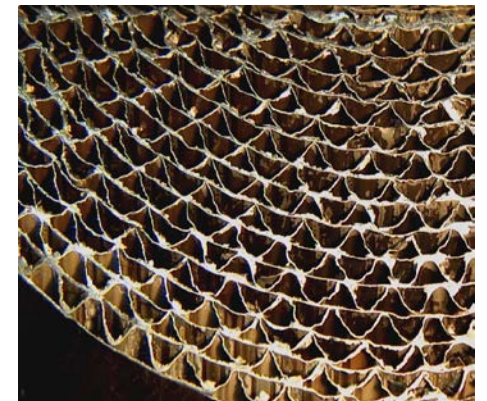

- German industrial application 250 kg in 6 months
nitrogen oven

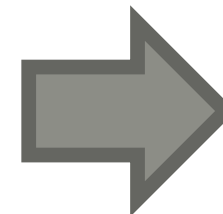

Phase 4: Verify – project closure and transfer

After finalizing the design and releasing it for sales, the project was closed and responsibilities were handed over to the other stakeholders, sales and service managers.



From prototype to final design

Conclusions:

- A catalytic thermal oxidation unit has been designed and implemented in SMD lines successfully using the Design for Six Sigma project methodology.
- A catalyst is an excellent device to crack the carbon molecules at a low temperature of approximately 225 °C.
- Catalysts in individual zones is feasible with catalyst installed in heavy contaminated zones, slot exhaust and first cool zone.
- In nitrogen environment the catalyst tends to be more effective and maintenance times are reduced.
- Nitrogen applications: keep oven clean (circulation of nitrogen to minimize N₂ consumption).
- Air applications: reduce contamination of exhaust system and minimize environmental emission.

Thank you very much!

Question?

References

- [1] <http://www.pollutionsystems.com/catalytic-oxidizers.html>
- [2] www.bosch-home.nl