

Characterization of Solder Defects in Package on Packages with AXI Systems for Inspection Quality Improvement

Zhen (Jane) Feng, Ph. D., David Geiger, Weifeng Liu, Ph.D., Anwar Mohammed, Murad Kurwa
AEG, FLEXTRONICS International Inc.
847 Gibraltar Drive, Milpitas, CA, USA 95035

George Tint, Ph. D.
Saki America
2378C Walsh Avenue, Santa Clara, CA 95051, USA

ABSTRACT

As a part of series of studies on X-Ray inspection technology to quantify solder defects in BGA balls, we have conducted inspection of 3 level POP package by using a new AXI that capable of 3D-CT imaging. The new results are compared with the results of earlier AXI measurements. It is found that 3D measurements offer better defect inspection quality, lower false call and escapes.

Keywords: AXI, 2DX, 3DX, planar CT, and POP.

INTRODUCTION

Package on Package (POP) devices are different from conventional SMT devices because they require solder attachment at different levels from the PCB surface. Their importance becomes ever greater as the POPs are increasingly utilized in various types of assemblies because designers want to take advantage of the 3D integration that offer superior performances in their new products. Therefore, achieving the best possible POP solder joint quality becomes important consideration for today's PCBA manufacturers.

Hence solder joints in a POP device are not inspectable by optical means, X-ray inspection mostly is the only way to inspect their quality nondestructively. Recently, Automated X-Ray Inspection AXIs (AXI3, AXI4) are found to have capabilities to detect not only for Solder Bridge, Missing Ball, Extra Solder, and Ball Voiding defects, but also for open/HIP for the bottom, and top layers of POP¹⁻². However AXI images are not as clear as 2DX and planar CT (pCT). In this project, we use an AXI with pCT (AXI5) capability to study the solder defects in POP to explore improvement in inspection quality improvements in a production environment.

The goal of this project was to evaluate the level of performance offered by different types of X-ray inspection equipment. It is good for the PCBA manufacturers to be able to test POP using AXI with pCT images. It is beneficial to have unambiguous images with Pass/Fail result AUTO output. Our project consists of three phases: 1. Analytical Comparison of images acquired by 2DX and AXI with pCT, 2. Exploration of possibilities to optimize the AXI with pCT algorithms in order to improve the quality of defect detection, and 3. Attempt to develop a process for AXI with pCT algorithm optimization. The optimal algorithm threshold settings will be discussed in the paper.

BACKGROUND

With more and more POP packages are on the production assemblies, how to have zero defects escape rate came to our focus during recent years. During early 2013, we faced the issue that some open defective pins on the top layer of POP were escaped from AXI. Therefore, we have been working with our engineers and X-ray vendors for this issue being resolved. In 2013, the best detecting coverage for open/HIP on the bottom layer was 85% with about 14,000+ false call PPM, and was about 50% defects detecting coverage with > 30,000 false call PPM for the top layer of POP. It was not available to detect open / HIP on top layer with 3 layers POP from our AXIs at that time. However with many efforts for

new software development, as well as Algorithms Threshold settings studies, good achievement was obtained in 2014¹. Both AXI 3 and AXI 4 have capabilities to detect open/HIP defects with 3 layers POP packages, and the average defects escaped is 4-8 % with about 20,000+ false call PPM. The challenge is getting clear image difference between good solder and bad solder pins while showing big separation for the main Algorithm measurement numerical data between them.

There was benefit with AXI capabilities to verify POP solder joints. Since November of 2013, we have not seen any defective pin on 3 layers POP from our SMT lines at our company site after SMT process improvement. With the real-time AXI testing data feedback, we are confident with our SMT process. Because of our AXI machine on the line with high false call PPM and not clear different X-ray images between good solder joint and bad solder joint, therefore usually we use 2DX to verify the defective pins which is called at AXI. In this way, we do rework only when it is a real defect.

EXPERIMENTS

In this project, we use AXI 5 for POP X-ray inspection. The reason we choose AXI 5 is that it not only has AXI capabilities, but also offers CT capabilities at reasonably high speed. These features (AXI & pCT) should provide more benefits for our SMT lines.

1. Summarization of Previous Experiments on AXI3, AXI 4

The inspection quality of AXI not only depends on the AXI machine design, but also on the structural complexity of a given POP. Figure 1 illustrates the 3 layers POP we utilized in this study which is assembled on a customer board. We do not test middle interposer ball layer of the POP on AXI as no SMT process is required on these pins. The POP structural information is tabulated in Table 1.

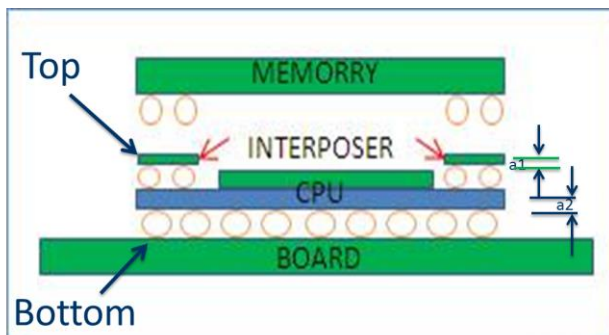

a1 (Substrate1) = 0.122 ±0.022 mm

a2 (Substrate 2) = 0.262 ±0.022 mm

Figure 1. Structure of 3 BGA layers POP on Customer Board

Table 1. Structural Information of POP Board in this Study

POP1 Customer Board	Layer (Unit)	Size
Size	Top (mm ²)	12x12
	Bottom (mm ²)	12x12
Pitch	Top (mm)	0.4
	Bottom (mm)	0.4mm
Bump height	Top (mm)	0.18
	Bottom(mm)	0.2
Ball Diameter	Top (mm)	0.25
	Bottom (mm)	0.25
Number I/O	Top	216
	Bottom	617
Bump material	Top	SAC 105
	Bottom	SAC 105

Table 2. Test Results Summary for the Top Layer of POP

POP Top	# of Defects	# of Defect Detected	# of False Call	Defect Escaped %	False call PPM
AXI 3	27	26	6	3.7%	27778
AXI 4	27	25	10	7.4%	46296

The 2DX results are adopted as the reference for the POP AXI study. We use two parameters (Defect Escaped % and False Call PPM) to evaluate the AXI capability. Table 2 summarized the results from inspections by AXI 3, and AXI 4. The definitions of Defect Escaped % and False Call PPM are expressed by Equation 1, and Equation 2.

Defect Escaped % = (Total # of Defect Escaped / Total # of Defects) X 100% Equation 1

False Call PPM= (Total # of False Call / Total # of Tested Pins) X 1,000,000 Equation 2

The 2DX, AXI3, and AXI 4 testing results shown with pins location in Figure 2. The cell colors are described as below.

- = Defect Caught by 2DX
- = Good pin confirmed by 2DX
- F = Defect Caught by AXI, False Call.
- X = Defect escaped at AXI, Escape.
- O = Defect Caught by both 2DX and AXI.

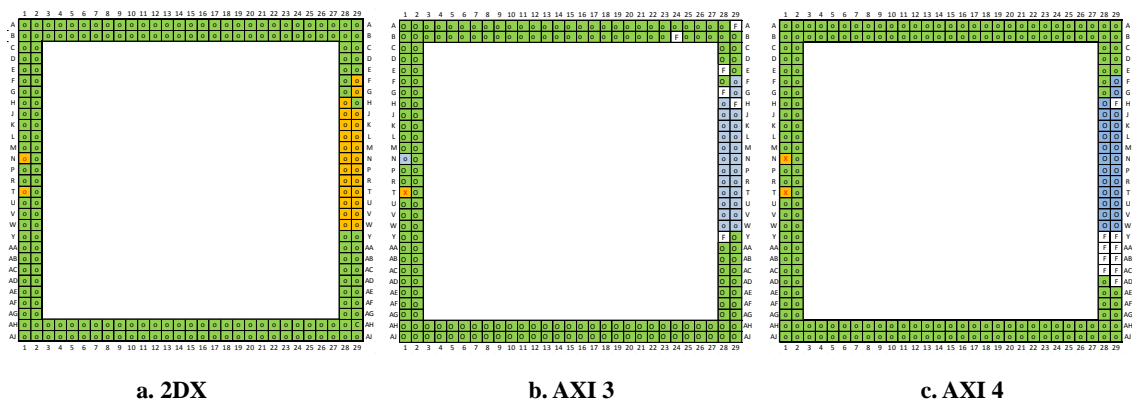

Figure 2. The Test Results of POP Board from 2DX, AXI3, AXI4

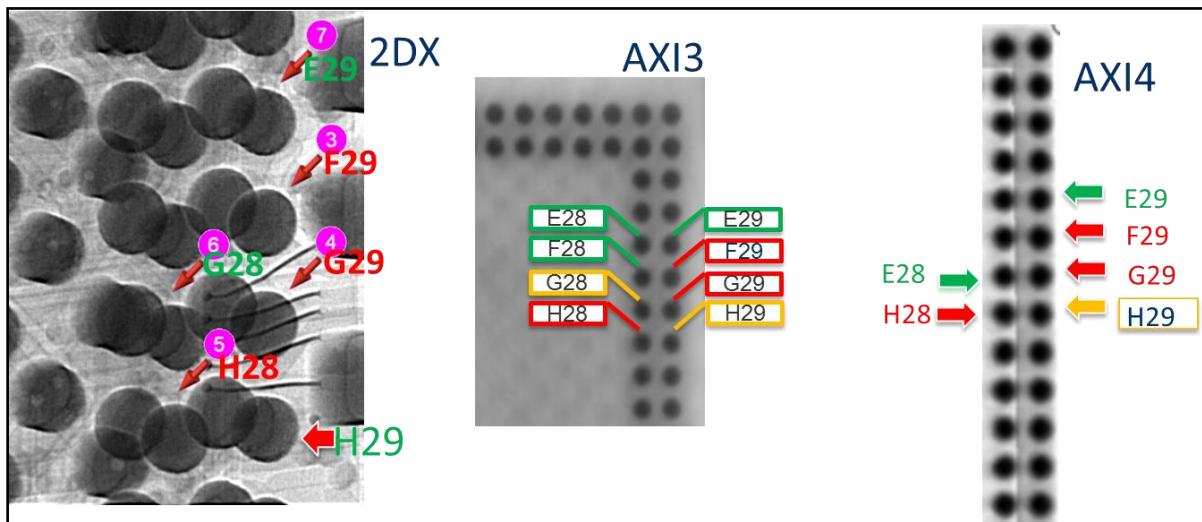

Figure 3. X-ray images for Detected HIP, Good solder, False Call pins from 2DX, AXI3, and AXI4.

Figure 3 shows X-ray images for Defective HIP, Good solder, and False Call pins on top BGA ball layer of the POP from 2DX, AXI3, and AXI4, where green, red, and yellow colors stand for Good solder joint, HIP/Open defective pin, and False Call pin respectively. It is obvious to see the difference for good solder and open solder on 2DX images. Based on the observed images, the big challenge in AXI is that there is no clear visible difference visible between the images of good solder joint versus defective HIP/Open pins. This is true for both AXI3, and AXI4 machines.

Therefore, our previous AXI study shows that AXI 3 and AXI 4 have capabilities to test POP including three ball layers by full AUTO mode with focus images for different BGA layers on POP Package. Both AXI3 and AXI4 have capabilities to detect POP open, HIP defects with some level of success. There is no clear visual distinction between AXI images of good versus bad pins, especially when it comes to HIP/Open defects. The requirement to balance for Defect Escaped % and False Call PPM was our main focus issue for AXI with POP package, and looking forward to having characterization of solder defects in POP with AXI systems for inspection quality improvement. That is why we are working with AXI 5 which has AXI and pCT capabilities for the POP project.

2. Highlights of AXI 5

Our experience tells us 2DX and/or CT are good non-destructive methods to verify BGA and POP defects, especially for HIP/Open. However 2DX and CT are rather considered manual testing tools. It is desirable to have an AXI machine with 2DX and pCT (planar CT for large board) capabilities. Recently we work with AXI 5 team, and test several packages which have been challenging to achieve good results on the AXI systems, the POP being one example.

Computed Tomography (CT) inspection technology have long been successfully applied to conduct failure analysis projects of PCB assemblies. In conventional CT for failure analysis, effective sample rotation of 360 degrees is necessary to acquire x-ray projected images and reconstruct 3 dimensional volumes with great structural details. However this CT procedure usually take too long time to routinely employ at production line environment. Therefore, 2D AXI inspection are more common so far on the plant floor.

AXI 5 with planar computer tomography (pCT) acquires a stack of slices which is typically 100 slices, but it can be more whenever necessary. The distance between 2 slices is typically 20 μm , but it can be less for higher resolution. From this stack of slices, the 3D reconstruction is done in real time on the machine PC while scanning. AXI 5 is especially good for inspecting 3D packages, like POP which require 3D-CT volumetric inspection for quality assurance. AXI 5 with new approaches to increase the acquisition and reconstruction speed: limited angle, planar CT, etc. Its planar CT approach with 16 sec/ 35 mm^2 speed for a FOV at 20 μm voxel resolution. It also has selective programmable inspection for any component with planar CT to catch defect in wide area, and operator independent pass/fail judgments including CT results/images which is very effective feature for SMT lines.

Figure 4 shows AXI 5 images for POP and HIP. Shape difference between good solder and bad solder pins for POP and BGA can easily be seen, and the speed with image qualities are comparable to normal 2DX and CT. Similar to the familiar AXI systems, AXI 5 detects defects based on Algorithm Threshold, however some measurement items of AXI 5 Algorithm can be direct measurements of absolute volume and volume ratio because it has 3D measurement capability.

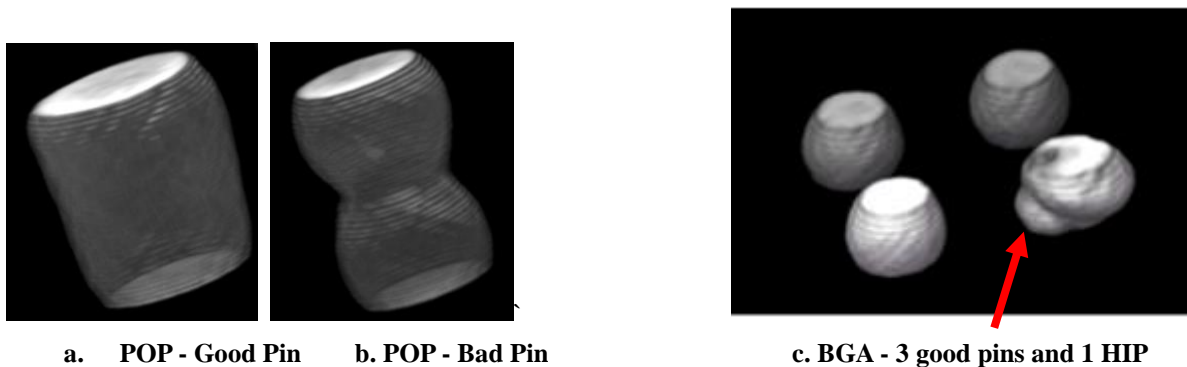

Figure 4. AXI 5 images for Detected HIP, HIP, and Good solder Pins

3. Experiments on AXI 5

With AXI 5, each solder ball can be framed to inspect under one or more measurement window. Two volume measurement Algorithms are applied: 1. Absolute Volume of the ball; 2. Upper and Lower Dome Volumes for their ratio calculation (Volume Ratio). The volume measurements are done using voxel element, a benefit of pCT images: 1. Use reconstructed pCT images of a real solder ball, its volume can be directly measured in voxel units; 2. Any volume deviation from the standard value indicates the defects like open, less wetting (HIP), as well as potential bridging of adjacent pins.

The ideal solder ball is a perfect sphere. If an ideal sphere, the solder volumes of Upper and Lower domes will be identical and their Volume Ratio (V_{ld}/V_{ud}) = 1. But there is almost no perfect ideal solder ball during the SMT process. There are several factors that influence the ball shape to deviate from a perfect sphere: Gravity; asymmetric contact angles due to different pads at the low and upper contacts in terms of pad sizes and material compositions.

In this project with AXI 5, we focus on the top layer of POP because it is most challenging for previous AXI testing. Based on the 2DX images, 27 defective pins were confirmed as shown in Table 2. AXI 5 automatically focused the BGA balls in the POP three layers, and qualities of solder balls are quantify by using volume algorithms: 1. Measure absolute volume for open / less wetting; 2. Comparing solder volumes composed of spherical dome sections sandwiched between the two facing pads. The volume dome section is 30% for the Upper and Lower ball.

The total number of pins for top layer POP is 216. The Volume Ratio threshold is set as ≥ 1.25 . The average Volume Ratio ($V_{ld}/V_{ud} = 1.13$) with maximum ($V_{ld}/V_{ud} = 1.45$) and minimum ($V_{ld}/V_{ud} = 0.97$). Figure 5 shows the Volume Ratio measurement data for the top layer of POP from AXI 5. There is separation between good pins and bad pins with the 216 pins of Volume Ratio measurement data.

With the threshold as ≥ 1.25 , total fail pins is 30 with 4 pins as false call, and 1 pin as a defect escaped based on the 2DX as the adopted Reference. Table 3 is the comparison between 2DX and AXI 5 for these 5 pin discrepancy. When we look at details for these pins with X-ray measurement data, three pins are considered as on the borderline of adopted threshold in the earlier study.

Let us observe 2DX and AXI 5 CT images for some of these pins. Figures 6 and 7 are images of pin # B29 of the top layer POP from AXI 5, and the 2DX respectively. The Volume Ratio ($V_{ld}/V_{ud} = 1.252$) for pin # B29, so AXI 5 calls the pin as a defect, and its measurement data is on the borderline close to Threshold value. The pCT image shows that pin is not a perfect solder joint as shown in Figure 6. The three pins with arrows are indicated are good solder pins in Figure 7: Because there is a circle at the top-left area ball on the 2DX image, it shows that the pin has good joints with the pad of the top layer of POP.

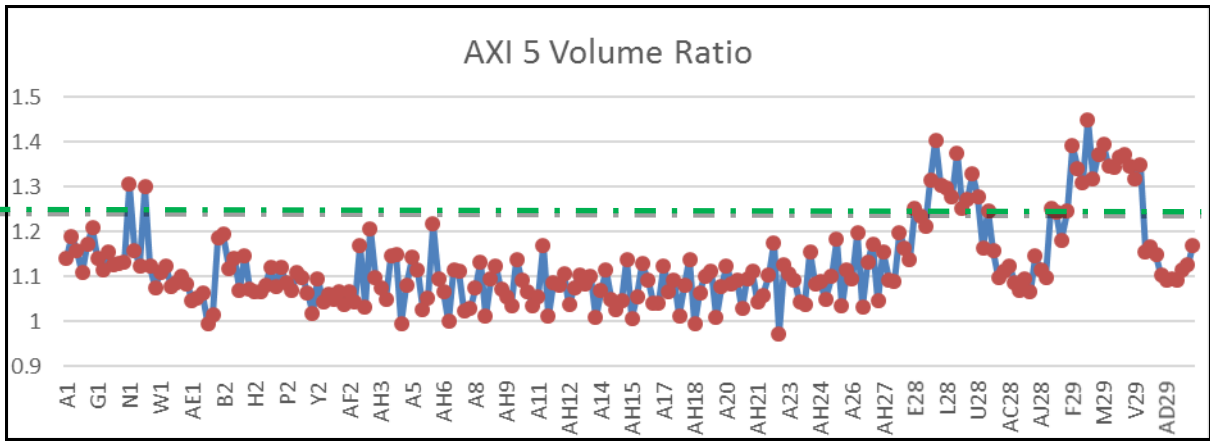

Figure 5. AXI 5 Volume Ratio Measurement Data for the Top Layer of POP, Volume Ratio Threshold ≥ 1.25 .

Table 3. Comparison between 2DX and AXI 5 for Top Layer of POP

Pin #	2DX	AXI 5	Volume Ratio	Note
B29	Good	Bad	1.2517	Borderline
E28	Good	Bad	1.2517	Borderline
E29	Good	Bad	1.2462	Borderline
H29	Good	Bad	1.3094	False call
V28	Bad	Good	1.1623	Escaped

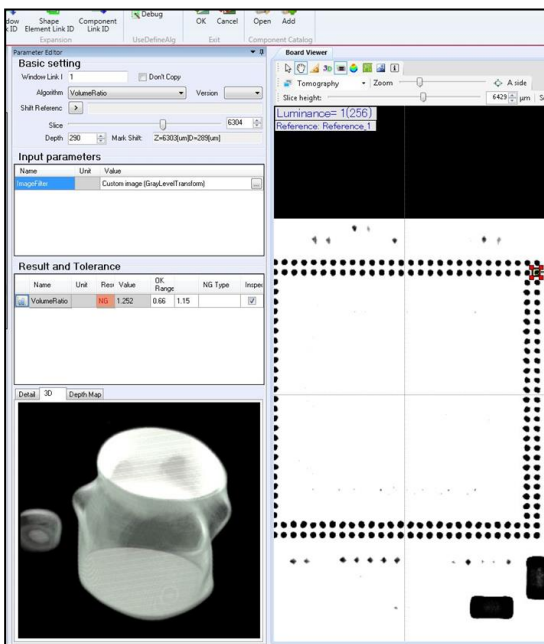

Figure 6. AXI 5 Image for Pin # B29

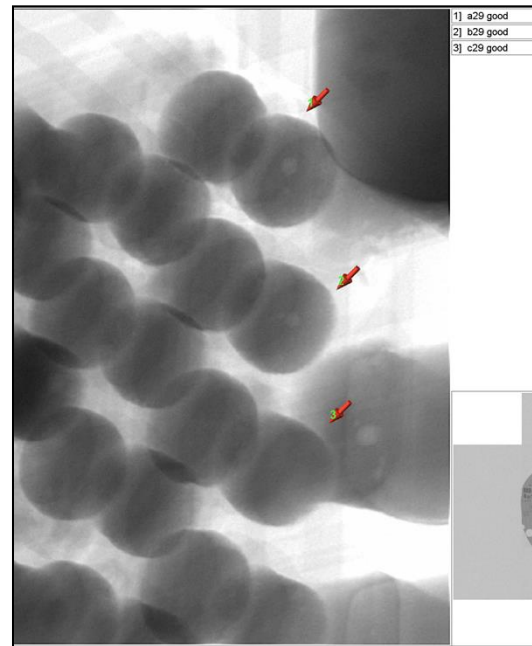

Figure 7. 2DX Image for Pin # B29

Figures 8 and 9 are images of the pin # V28 on the top layer POP from AXI 5 and the 2DX, respectively. Hence the Volume Ratio ($V_{ld}/V_{ud} = 1.116$) for pin # V28, so AXI 5 calls the pin as a good solder joint due to its measurement data which is smaller than the Threshold ($V_{ld}/V_{ud} = 1.25$). However its pCT image shows that the pin is not a perfect solder joint as shown in Figure 8. In Figure 8, two yellow arrows are defective pins (V28, W28) on the 2DX image, one green arrow is a good pin (Y28) due to visible circular features at the top-left area of the ball on 2DX image. Table 4 listed test data summary of AXI 3, AXI 4, and AXI 5 with the top layer of POP. The AXI 5 has significantly better test results (defect escaped 3.7% with false call PPM as 18,518) among the AXI 3, AXI4, and AXI 5. We are working on further reducing false call PPM by the Algorithm optimization and additional profile testing.

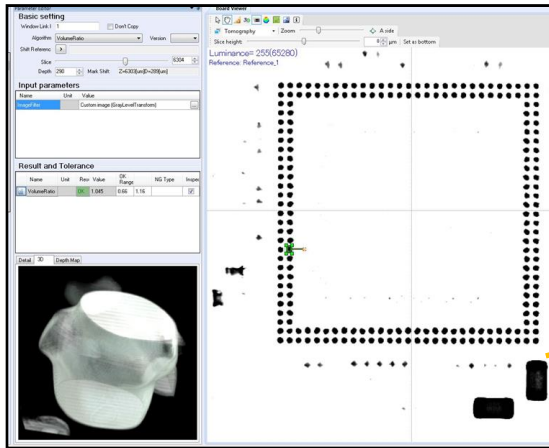

Figure 7. AXI 5 Image for Pin # V28

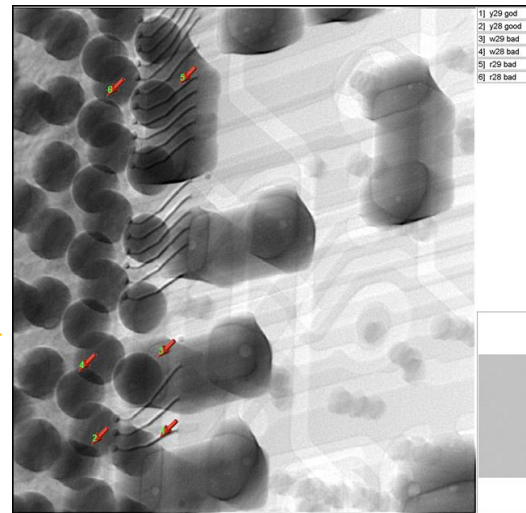

Figure 8. 2DX Image for Pin # V28, W28, Y28

Obviously, the algorithm threshold setting affects its testing results. Collecting more data in real production environment will certainly enhance such engineering decisions of threshold setting. In Table 4, we tabulated AXI 5 Volume Ratio threshold settings versus its testing results. It is obvious to see the setting is 1.25 which is a good number for this case. Table 5 is the summary of AXI 5 with other two AXIs test results conducted previously.

Table 4. AXI 5 Volume ratio Threshold Setting versus Testing Results

AXI 5 Threshold	# of Defect Escaped	# of False call	Defect Escaped %	False call PPM
1.30	8	1	29.63%	4630
1.25	1	4	3.70%	18519
1.20	1	10	3.70%	46296
1.16	0	25	0.00%	115741

Table 5. Test Summary of AXI 3, AXI 4, and AXI 5 with Top Layer of POP

POP Top	# of Defects	# of Defect Detected	# of False Call	Defect Escaped %	False call PPM
AXI 3	27	26	6	3.7%	27778
AXI 4	27	25	10	7.4%	46296
AXI 5	27	26	4	3.7%	18518

CONCLUSIONS

As an extended study of earlier reported projects, we have conducted inspection of solder defects on the top layer of mounted POP devices by an AXI system capable of high speed CT imaging, AXI 5.

- AXI 5 produced better testing results with the top layer of POP as shown in Table 5. The interesting facts are that pCT pass/fail calls generated by AXI 5 are independent from operator judgments, and they can be automatically saved to a server to be reviewed by the engineers.
- The attribute Gage RR results are in progress.
- This project is still ongoing to develop a process for AXI with pCT algorithms and parameter optimization.
- For POP applications, 3D imaging offer less ambiguous decisions for solder bridges, open defects while 2D or 2.5D images sometimes encounter confusion from the shadow of neighbors.

- This study on POP with AXI 5 is just a start, while more packages evaluation like connectors ongoing to utilize the machine's 3D imaging capability in a wider range of applications³.

REFERENCES

- [1] David Geiger, Zhen (Jane) Feng, Ph. D., Weifeng Liu, Ph.D., Hung Le, Tho Vu, Anwar Mohammed, Murad Kurwa and Evstatin Krastev Ph.D., "Optimizing X-ray Inspection with Package on Package", Proceedings of SMTAI, September, 2014.
- [2] Alejandro Castellanos, Zhen (Jane) Feng, Ph. D., David Geiger, Murad Kurwa, "Head in Pillow X-ray Inspection", SMT, May 2014.
- [3] David Geiger, Zhen (Jane) Feng, Ph. D., et al, "Connector with X-ray Inspection", project is ongoing.

ACKNOWLEDGEMENTS

The authors would like to thank the company X-ray team who were involved in supporting this study, especially for Tho Vu, Hung Le, Phuong Chau, Jiyang Zhang; AXI3, AXI4, AXI5, and 2DX support teams.



Characterization of Solder Defects in Package on Packages with AXI Systems for Inspection Quality Improvement

**Zhen (Jane) Feng, Ph. D., David Geiger, Weifeng Liu, Ph.D., Anwar Mohammed, Murad Kurwa
FLEXTRONICS International Inc.
847 Gibraltar Drive, Milpitas, CA, USA 95035**

**George Tint, Ph. D.
Saki America
2378C Walsh Avenue, Santa Clara, CA 95051, USA**



Outline/Agenda

- Introduction
Inspection - Detection – Prevention
AXI: Laminography, Tomosynthesis, Planar CT
- Previous Experiment
AXI 3, AXI 4 with 3 layers POP
- Highlight AXI 5
- Experiment
POP data from AXI 5
- Conclusions



Introduction

- ❖ Prevention is better than Detection.
- ❖ AXI Best practices include how to use attribute and measurement data to improve SMT process and AXI Algorithm Threshold settings
- ❖ Previous POP AXI (Tomosynthesis) studies done on AXI 3, and AXI4.
- ❖ POP with 2 & 3 layers
- ❖ AXI5 is Tomosynthesis & Planar Computer tomography (pCT). We focus on top layer POP using AXI 5. Better AXI Algorithm and X-ray images are expected for detecting POP open, especially for the top layer .



Background

- ❖ Optimal X-ray inspection methods are essential to have ZERO POP defect escape rate.
- ❖ It is important for the PCBA manufacturers to be able to test POP using Automated X-Ray Inspection (AXI) within the SMT line.
- ❖ Looking for the AXI with more capabilities:
 1. AXI images with clear difference between good and bad pins, especially for open/HIP
 2. Testing results are independent with AXI operators



Board POP Review

- ❖ The inspection quality of AXI not only depends on the AXI machine design, but also on the on the structural complexity of a given POP.
- ❖ It is not easy to identify POP solder joint defects within 3 BGA layers.

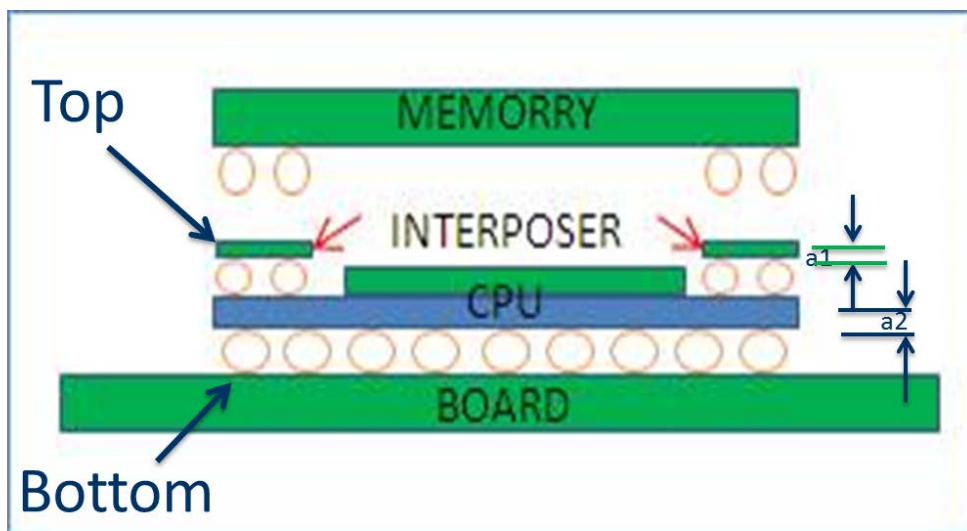

a_1 (Substrate1) = 0.122 ± 0.022 mm
 a_2 (Substrate 2) = 0.262 ± 0.022 mm

POP1 Customer Board	Layer (Unit)	Size
Size	Top (mm ²)	12x12
	Bottom (mm ²)	12x12
Pitch	Top (mm)	0.4
	Bottom (mm)	0.4
Bump height	Top (mm)	0.18
	Bottom (mm)	0.2
Ball Diameter	Top (mm)	0.25
	Bottom (mm)	0.25
Number I/O	Top	216
	Bottom	617
Bump material	Top	SAC 105
	Bottom	SAC 105



2DX verified solder joints
 on the 3rd BGA layer : **good**
joint, bad joint.

X-ray Images

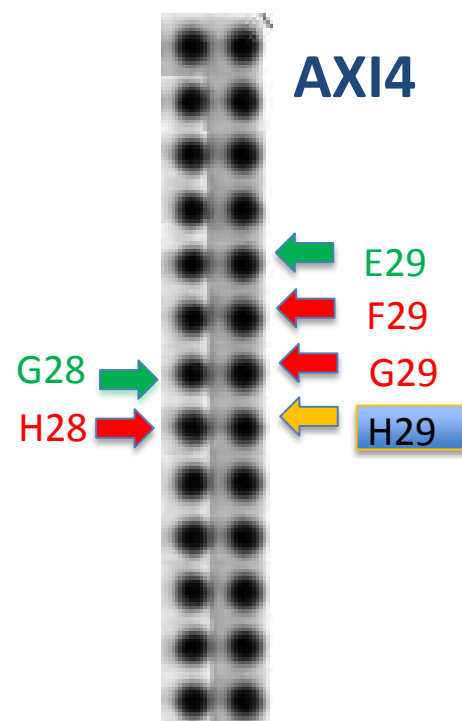
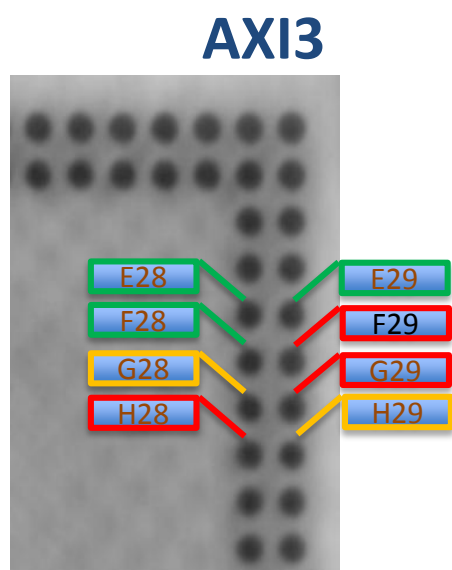
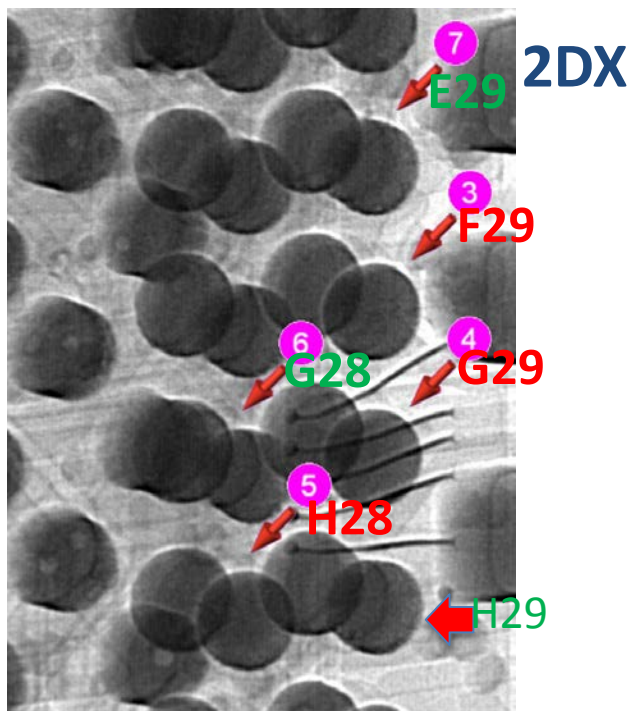

7=E29, E28
 3= F29, F28
 4=G29, 6=G28
 5=H28, H29

7=E29, E28,
 3= F29 (escaped), F28
 4=G29, 6=G28 (false call)
 5=H28, H29 (false call)

7=E29, E28,
 3= F29 (escaped), F28
 4=G29, 6=G28
 5=H28, H29 (false call)



Test Results Summary for the Top Layer of POP

POP Top Layer	# of Total Defects	# of Defect Detected	# of Total False Call	Defect Escaped %	False call PPM
AXI 3	27	26	6	3.70%	27778
AXI 4	27	25	10	7.41%	46296

False Call PPM (Bottom) = False call # X 1000000/617

False Call PPM (Top) = False call # X 1000000/216



Highlights AXI 5

- ❖ Computed Tomography (CT) technology has long been successfully used to conduct failure analysis of PCB assemblies.
- ❖ In conventional CT for failure analysis, effective sample rotation of 360 degrees is necessary to acquire x-ray projected images and reconstruct 3 dimensional volumes with great structural details.
- ❖ However, the procedure usually take too long time to be routinely employed at production line environment. Therefore, 2D AXI inspection is more common so far in this regard.

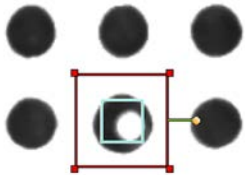

- Tomography slice

1. AXI 5 with planar computer tomography (pCT) acquires a stack of slices which is typically 100 slices, but it can be more whenever necessary.
2. The distance between 2 slices is typically 20 μ m voxel resolution, but it can be less for higher resolution.

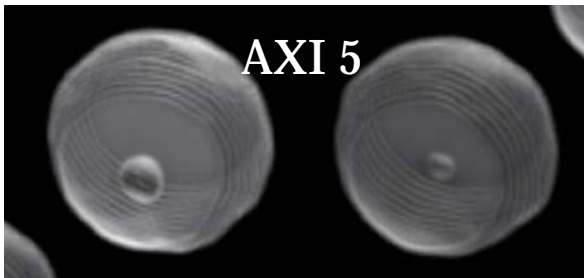

- 3D reconstruction

From this stack of slices, the 3D reconstruction is done in real time on the machine PC during the PCB scanning.



Why 3D Inspection in PCBA Production?

- ❖ Recently, many POP chips are mounted on the PCBA production. POPs are also called as 3D packages.
- ❖ 3D packages naturally require 3D-CT volumetric inspection for quality assurance.
- ❖ AXI 5 has capabilities to detect non-wetting solder joint (Head in Pillow (HIP))

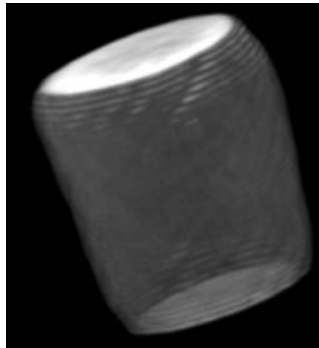

Ok ball

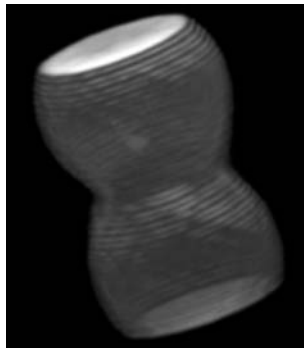

NG ball

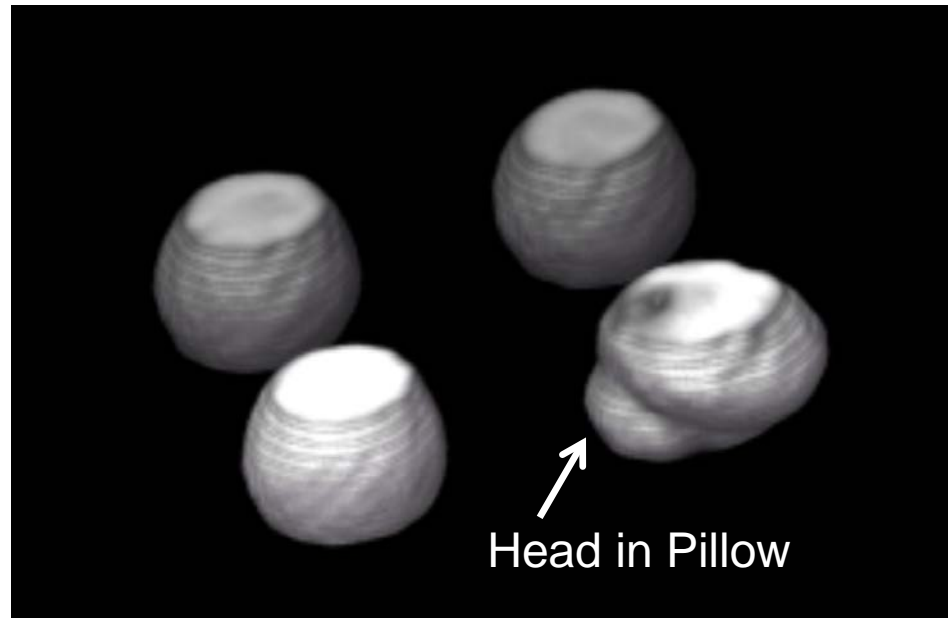

Head in Pillow



Desirable Specifications for in-Line Use

AXI5 with new approaches to increase the acquisition and reconstruction speed: limited angle, planar-CT, etc. With good enough image quality, the inspection speed must be in a few tens of seconds per a field of view, rather than minutes as provided by conventional CTs.

AXI-5 employs planar CT approach: 16 sec/ 35 mm square FOV at 20um resolution

- ❖ Design CAD/Gerber data are used to program the inspection of component defects at desired locations on the PCBA size of 18X20 inches (max)
- ❖ Selective programmable inspection for any component with planar CT to catch defect in wide area
- ❖ Fully Automated handling capability
- ❖ Operator independent pass/fail judgments



AXI 5 POP Data Measurements

- ❖ Each solder ball is framed with each measurement window
- ❖ Two Volume Measurement Algorithms are applied
 1. Absolute Volume of the balls
 2. Upper and Lower Dome Volumes for their ratio calculation
- ❖ Volume measurements are done using voxel element, a benefit of CT imaging
 1. Using reconstructed CT image of a real solder ball, its volume can be directly measured in voxel units.
 2. Any volume deviation from the standard value indicates potential defects like less wetting (HIP), as well as potential bridging of adjacent pins.



AXI5 POP Volume Ratio Analysis Considerations

- ❖ Ideal solder ball is a perfect sphere.

If ideal sphere, the solder volumes of upper and lower domes will be identical and their ratio

$$V_{ld}/V_{ud} = 1.00$$

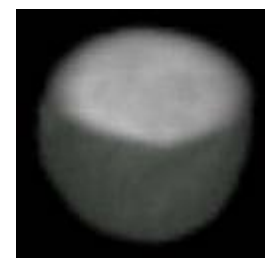

- ❖ There are several factors that influence the ball shape to deviate from a perfect sphere:
 - Gravity
 - Asymmetric contact angles due to different pads at lower and upper contacts in terms of pad sizes and material compositions



AXI-5 Results for POP

- ❖ AXI-5 automatically focuses the BGA balls in PoP Layer 3
- ❖ The qualities of solder balls are quantified by using volume algorithms:
 1. measuring absolute volume for less wetting
 2. comparing solder volumes composing spherical dome sections sandwiched between the two facing pads
- If these volumes are identical, the volume ratio = 1 and the ball is considered a symmetrical sphere, ideal bond.
- If the Volume Ratio is over certain threshold value (25%), the ball is not spherical, open / head-in-pillow defect



AXI 5 POP Volume Ratio Analysis Considerations

- ❖ Total Ball count at PoP Memory Layer = 216
- ❖ Volume Ratio Summary
 - Average $V_{ld} / V_{ud} = 1.13$
 - Maximum $V_{ld} / V_{ud} = 1.45$
 - Minimum $V_{ld} / V_{ud} = 0.97$
- ❖ Algorithm Volume Ratio Threshold ≥ 1.25

Pin #	2DX	AXI 5	Volume Ratio	Note
B29	Good	Bad	1.2517	Borderline
E28	Good	Bad	1.2517	Borderline
E29	Good	Bad	1.2462	Borderline
H29	Good	Bad	1.3094	False call
V28	Bad	Good	1.1623	Escaped



AXI 5 Measured Data and Analysis

Location	Volume Ratio
N1	1.30506956577301
T1	1.29900074005127
E28	1.25168776512145
F28	1.23386991024017
H28	1.31479179859161
J28	1.40314400196075
K28	1.30343699455261
L28	1.29658579826355
M28	1.27765071392059
N28	1.37462639808655
P28	1.25267803668976
R28	1.27175939083099
T28	1.32759273052216
U28	1.27619671821594
V28	1.16227817535400
W28	1.24721777439117
B29	1.25169289112091
C29	1.24433279037476
E29	1.24623227119446
F29	1.39087891578674
G29	1.34031951427460
H29	1.30938339233398
J29	1.44988083839417
K29	1.31733870506287
L29	1.37213814258575
M29	1.39306640625000
N29	1.34641396999359
P29	1.34342718124390
R29	1.36603772640228
T29	1.37070751190186
U29	1.34503495693207
V29	1.31714832782745
W29	1.34790050983429

	Volume Ratio	Ratio Range
W28	1.24721777439117	≥1.20 , < 1.25
L28	1.29658579826355	≥ 1.25, < 1.30
N1	1.30506956577301	≥1.30

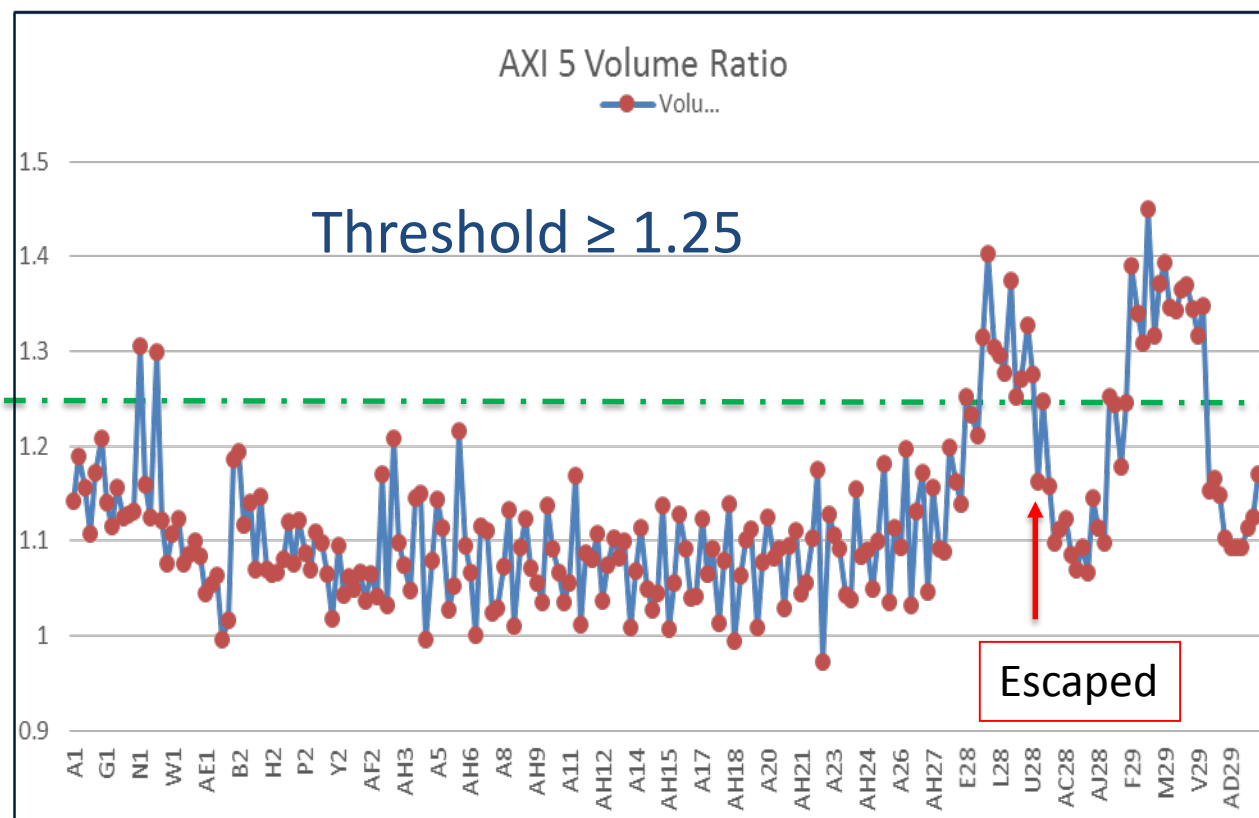



Images pin # B29 : AXI 5 vs. 2DX

Pin #	2DX	AXI5
B29	Good	Bad

VR = 1.252 is the borderline of Threshold.
 Threshold > **1.25**, AXI 5 calls as **defective** pin.

Parameter Editor

Basic setting

Window Link: 1

Algorithm: VolumeRatio

Shift Reference: Slice 6304, Depth 290, Mark Shift: Z=6303(um)D=289(um)

Input parameters

Name	Unit	Value
ImageFilter		Custom image (GrayLevelTransform)

Result and Tolerance

Name	Unit	Resi. Value	OK Range	NG Type	Inspect
VolumeRatio		1.252	0.65 - 1.15		<input checked="" type="checkbox"/>

Pin # B29
 Volume Ratio
 = **1.252**

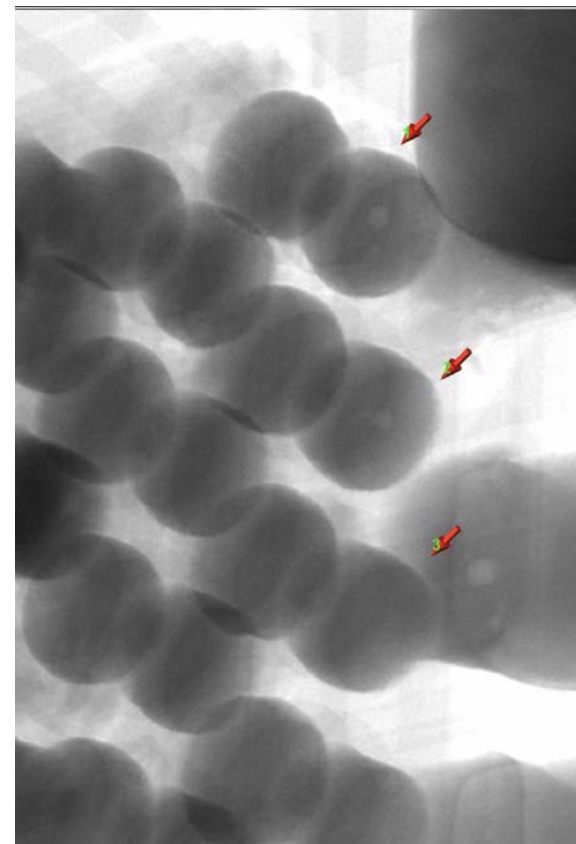

- 1) a29 good
- 2) b29 good
- 3) c29 good

2DX

Pin # B29





Images pin # V28 : 2DX versus AXI 5

Threshold ≤ 1.25 , AXI 5 calls as **good** pin.

Pin #	2DX	AXI5
V28	Bad	Good

Parameter Editor

Basic setting
 Window Link: 1
 Algorithm: VolumeRatio
 Shift Reference: >
 Slice: 5304
 Depth: 250 Mask Shift: Z=6303(um)D=285(um)

Input parameters
 Name Unit Value
 ImageRatio Custom image (DragLevelTransform)

Result and Tolerance

Name	Unit	Res	Value	OK Range	NG Type	Inspec
VolumeRatio		OK	1.045	0.66 1.16		[?]

Detail: 3D Depth Map

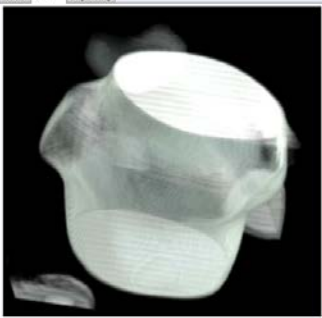

Board Viewer

Tomography Zoom A side
 Slice height: 0.2 um Set as bottom
 Luminance= 255(65280)
 Reference: Reference_1

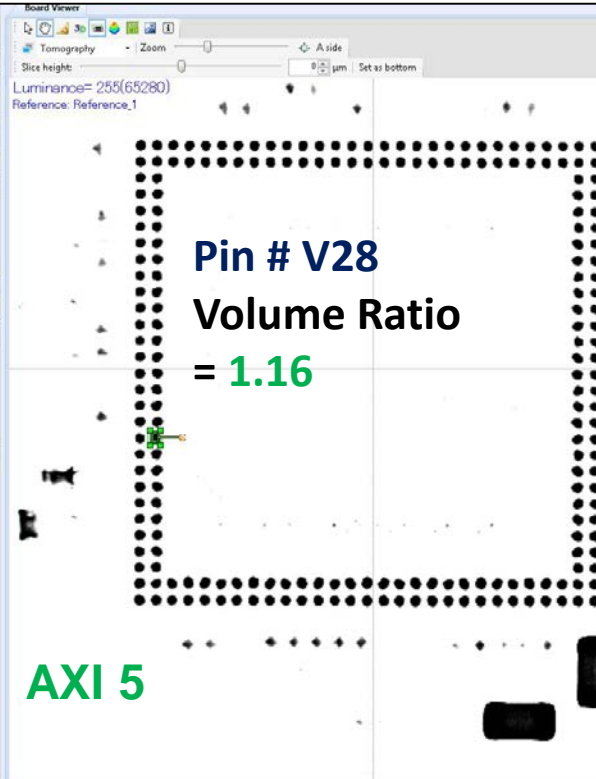

Pin # V28
Volume Ratio
= 1.16

AXI 5

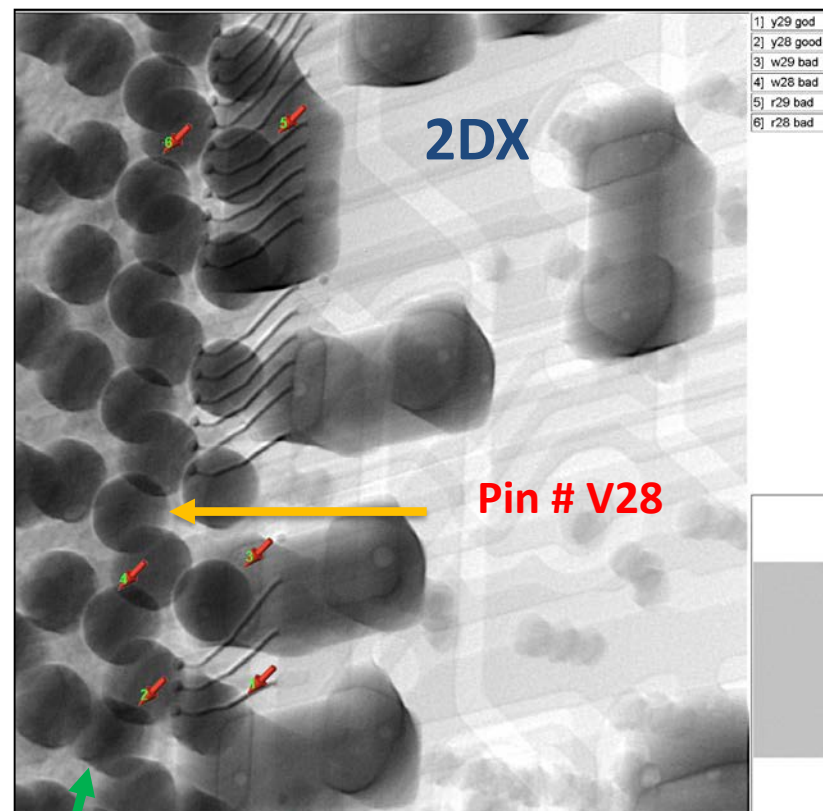

Pin # Y28 good



AXI 5 Threshold Settings versus Test Results

AXI 5 Threshold	# of Defect Escaped	# of False call	Defect Escaped %	False call PPM
1.30	8	1	29.63%	4630
1.25	1	4	3.70%	18519
1.20	1	10	3.70%	46296
1.16	0	25	0.00%	115741



Test Summary of AXI 3, AXI 4, and AXI 5 with Top Layer of POP

POP Top Layer	# of Defects	# of Defect Detected	# of False Call	Defect Escaped %	False call PPM
AXI 3	27	26	6	3.70%	27778
AXI 4	27	25	10	7.41%	46296
AXI 5	27	26	4	3.70%	18518



Conclusions

As an extended study of earlier reported projects, we have conducted inspection of solder defects on the top layer of mounted POP devices by an AXI system capable of high speed CT imaging, AXI 5.

- ❖ AXI 5 produced better testing results with the top layer of POP. The interesting facts are that pCT pass/fail calls generated by AXI 5 are independent from human operator judgments, and they can be automatically saved to a server to be reviewed by the engineers
- ❖ The attribute Gage RR results will be done soon.
- ❖ This study on POP with AXI 5 is just a start, while more packages like connectors are ongoing to utilize the machine's 3D imaging capability in a wider range of applications.
- ❖ This project is still ongoing to develop a process for AXI with pCT algorithms and parameters optimization.



Acknowledgements

Company manufacturing process and test teams, especially to Hung Le, Phuong Chau, Tho Vu, and Jiyang Zhang; AXI3, AXI4, AXI5, and 2DX support teams.

Thank you for attending!